



PDHonline Course C663 (8 PDH)

Force Main Rehabilitation

Instructor: Dennis G. Shin, PE

2020

PDH Online | PDH Center

5272 Meadow Estates Drive
Fairfax, VA 22030-6658
Phone: 703-988-0088
www.PDHonline.com

An Approved Continuing Education Provider

State of Technology Report for Force Main Rehabilitation



Final

**State of Technology Report for
Force Main Rehabilitation**

by

**Robert Morrison, P.E.
Tom Sangster
Jason Consultants, LLC**

**Lili Wang, P.E.
Wendy Condit, P.E.
Battelle Memorial Institute**

**Contract No. EP-C-05-057
Task Order No. 58**

for

**Ariamalar Selvakumar, Ph.D., P.E.
Task Order Manager**

**U.S. Environmental Protection Agency
National Risk Management Research Laboratory
Water Supply and Water Resources Division
2890 Woodbridge Avenue (MS-104)
Edison, NJ 08837**

**National Risk Management Research Laboratory
Office of Research and Development
U.S. Environmental Protection Agency
Cincinnati, Ohio 45268**

DISCLAIMER

The work reported in this document was funded by the United States Environmental Protection Agency (EPA) under Task Order (TO) 58 of Contract No. EP-C-05-057 to Battelle Memorial Institute, Columbus, OH. The EPA, through its Office of Research and Development, funded and managed, or partially funded and collaborated in, the research described herein. This document has been subjected to the Agency's peer and administrative review and has been approved for publication. Any opinions expressed in this report are those of the author(s) and do not necessarily reflect the views of the Agency, therefore, no official endorsement should be inferred. Any mention of trade names or commercial products does not constitute endorsement or recommendation for use.

FOREWORD

The U.S. Environmental Protection Agency (EPA) is charged by Congress with protecting the Nation's land, air, and water resources. Under a mandate of national environmental laws, the Agency strives to formulate and implement actions leading to a compatible balance between human activities and the ability of natural systems to support and nurture life. To meet this mandate, EPA's research program is providing data and technical support for solving environmental problems today and building a science knowledge base necessary to manage our ecological resources wisely, understand how pollutants affect our health, and prevent or reduce environmental risks in the future.

The National Risk Management Research Laboratory (NRMRL) is the Agency's center for investigation of technological and management approaches for preventing and reducing risks from pollution that threaten human health and the environment. The focus of the Laboratory's research program is on methods and their cost-effectiveness for prevention and control of pollution to air, land, water, and sub-surface resources; protection of water quality in public water systems; remediation of contaminated sites, sediments and ground water; prevention and control of indoor air pollution; and restoration of ecosystems. NRMRL collaborates with both public and private sector partners to foster technologies that reduce the cost of compliance and to anticipate emerging problems. NRMRL's research provides solutions to environmental problems by: developing and promoting technologies that protect and improve the environment; advancing scientific and engineering information to support regulatory and policy decisions; and providing the technical support and information transfer to ensure implementation of environmental regulations and strategies at the national, state, and community levels.

This publication has been produced as part of the Laboratory's strategic long-term research plan. It is published and made available by EPA's Office of Research and Development to assist the user community and to link researchers with their clients.

Sally Gutierrez, Director
National Risk Management Research Laboratory

EXECUTIVE SUMMARY

Introduction

Force mains that carry sewage flows under pressure represent a special set of challenges for sewer rehabilitation. Force mains represent about 7.5% of the wastewater system and they typically use materials that are not commonly used in gravity sewer systems. Ductile iron (DI), cast iron (CI), steel, and concrete pressure pipe are all material types that are frequently used for sewer force mains, especially in larger diameters. All of these materials are susceptible to both internal corrosion from the sewage flow (liquid and gaseous states), as well as external corrosion due to the environment in which the pipe is buried.

Historically, the most common renewal technology employed has been to replace the main using open cut construction. Part of the reason for that choice has been a lack of rehabilitation technologies appropriate for sewer force mains. There is a wealth of technologies available for gravity sewers, but the field has been limited for pressurized systems. Fortunately, that situation is changing as more vendors recognize the growing opportunity in sewer force main rehabilitation. The other reason for replacement is that sewer force mains tend to have a fairly high consequence of failure. A rupture of a sewer force main could release millions of gallons of raw sewage into the environment posing significant health risks to the general public. Cleanup costs can be staggering.

As some of the newer rehabilitation technologies develop a positive track record of use in sewer force mains and confidence in their design approach and installation process strengthens, more utilities will be willing to consider these trenchless technologies as potential renewal solutions. Trenchless methods have proven themselves to be cost-effective for gravity sewer mains, especially when both direct and indirect costs associated with a replacement program are considered. A similar outcome is expected for sewer force mains once data on the effectiveness and longevity of these technologies and materials and life-cycle costs become more readily available.

Recognizing that there would be some cross-over amongst the various rehabilitation technologies common to water mains and gravity sewers, a series of technology-specific datasheets were created for each identified rehabilitation technology deemed relevant to sewer force mains and are included as Appendix A of this report. An effort was made to collect representative cost information, but often only limited cost data were available.

Characteristics of Force Mains

The approximate length of the force main system in the US is 60,000 miles (96561 km). The Water Environment Research Foundation (WERF) recently published a report titled “Guidelines for the Inspection of Force Mains” (WERF, 2009). The data from this WERF survey are presented and characterize the types of pipe materials used, diameter ranges, ages, location accessibility, and failure modes and mechanisms for force mains. Ferrous pipe materials (i.e., CI, DI, and steel) represent on average 63.4% of all pipes used for force mains. Over 91% of sewer force mains are between 4 and 36 inches (100 and 900 mm) in diameter, which are within the non-man entry size range and only 2% are beyond 50 years in age. Over 91% of the force main pipes are buried. Only 5% of the total number of force mains surveyed for the WERF project had some built-in redundancy.

Internal corrosion was rated as being responsible for ferrous force main failures 26.2% of the time, ahead of all other known causes. External corrosion at 19.2% and third-party damage at 19.4% are the next most common causes of failures in ferrous mains. The most common single cause of failure in non-

ferrous force mains is third-party damage, which accounts for 37% of failures. Corrosion and structural failure together account for 54% of failures.

Renewal Technologies

Renewal of force mains includes repair, rehabilitation, and replacement. The estimate of renewal works in force mains are between 250,000 and 600,000 linear feet (76,220 and 182,927 meters) or 0.08% to 0.19% of the total length on an annual basis. Replacement comprises between 200,000 and 500,000 linear feet (60,976 and 152,439 meters) of force mains annually or some 0.1% to 0.15% of the total length. The best estimate is that between 50,000 and 100,000 linear feet (15,244 and 30,488 meters) of force mains in the US are rehabilitated annually. This represents some 0.02% to 0.03% of the overall length. There are a variety of reasons for this lower rate of rehabilitation in sewer force mains. The first is the lack of consistently reliable and cost-effective sewer force main inspection methods and the second is the low number of rehabilitation technologies specific to force mains.

Force mains can operate with a wide range in pressures, from a few feet of head to hundreds, so there is potentially a large number of technologies that can be adapted to force mains from other applications. Vendors are constantly making improvements to their products so they should always be consulted before using any of the identified technologies.

Repair

Repair of a failure or a deteriorated section of pipe is generally focused on only taking remedial action with one or two sections of pipe. Oftentimes this work is done under emergency conditions. The first objective is to prevent any further spill or damage to the environment and the second objective is to restore service as quickly as possible. Repair can be broken down into open cut replacement of a section(s) of pipe, spot repairs using cured-in-place-pipe (CIPP), mechanical sleeves or repair clamps, or joint repairs using internal sleeves or external devices. Some examples of each are given in this report, but repair is not a focus of this report.

Rehabilitation

In rehabilitation, the existing pipe becomes part of the renewal work. Rehabilitation methods will include the use of spray-on linings, close-fit linings, CIPP, and woven hose lining systems. Technologies for each of these rehabilitation categories are discussed in this report in addition to cleaning requirements prior to rehabilitation. Because only limited rehabilitation work has been undertaken to date on sewer force mains, many of the systems available were originally developed for water main rehabilitation, but can be adapted to sewer force mains.

Spray-on linings have been one of the easiest methods of rehabilitating a pressurized main when the primary objective is just to provide corrosion protection to the interior surface. Spray-on linings include cementitious and polymer materials. Two polymers, epoxy and polyurethane, are used extensively in the UK water industry to line water mains. Rapid cure time over cement mortar and resistance to soft water have favored these materials. A new family of polymer spray-on linings, based on the use of polyurea, is finding rapid acceptance for lining manholes, wetwells, and other structures exposed to corrosive environments including pipes. One of the benefits of the use of polyurea is a very fast cure, with gel times in 5 to 40 seconds. The liner can also be spray applied with a thickness up to 2 inches (50 mm). This liner has the ability to serve as a semi-structural or structural liner and not just provide corrosion protection.

The use of close-fit liners is often called modified sliplining. It involves the use of a thin walled liner with an outside diameter that is similar to the inside diameter of the host pipe. The key to installing the liner is to temporarily reduce the liner diameter to facilitate its insertion into the host pipe. Once the liner is in place, it is reverted back to its original outside diameter forming a close fit to the host pipe. The two methods of temporarily reducing the diameter of the liner is symmetrical or fold-and-form. Polyethylene (PE) pipe is used for the symmetrical reduction process, and both PE and polyvinyl chloride (PVC) for fold-and-form.

CIPP is by far the leading method for the rehabilitation of gravity sewers. With the expiration of the original patent on CIPP, many new variants have been introduced. The main differences are based on tube construction, method of installation, curing method, and type of resin.

Woven hose linings differ from ordinary CIPP products by the construction of the tube reinforcement. Rather than being made of a felt-type material, hose liners are made from either polyester, glass, or aramid fibers that are woven into a hose-type configuration, similar to the type of construction used for fire hoses. Three types of woven hose lining systems are discussed including adhesive-backed linings, non-adhesive backed linings, and glass-reinforced thermoplastic linings.

Replacement

Replacement involves the installation of a new fully structural pipe to take over the functions of the deteriorated force main. Several technologies are available for online and offline replacement. Historically, the most common method has been offline replacement by open cut, as the work can be undertaken with the existing main in operation and it results in a brand new pipe with a known design life.

The second most common method of replacement has been sliplining. Sliplining involves the insertion of a new pipe with a smaller outside diameter than the inside diameter of the pipe to be rehabilitated. Pipe lengths can be fused together to create a long continuous string, frequently done with PE and Fusible PVC™, which is then pulled into the host pipe. Alternatively, especially when site conditions prevent pre-joining long strings of pipe, discrete pipe sections can be jointed one at a time and pushed into the host pipe. PVC, DI, and fiberglass reinforced plastic/glass reinforced plastic (FRP/GRP) pipes are typically sliplined in this fashion. Mechanically restrained joints can also be employed with these materials, which would allow pulling of the pipe into place.

Pipe bursting involves the breaking up of the old pipe and pushing it into the surrounding soil by passing a bursting or splitting device through it, while pulling a replacement pipe in behind the bursting head. The replacement pipe is usually high density polyethylene (HDPE), PVC, or DI. In some cases, the process can be used to expand the void created thus upsizing with the insertion of a larger diameter. Pipe bursting has now been accomplished in diameters from 4 to 60 inches (100 to 1,500 mm). The three basic bursting methods include static, hydraulic, and pneumatic bursting.

Offline replacement simply involves the installation of a new pipe without regard to the line and grade of the existing pipe. Normally, the existing deteriorated pipe being replaced is kept in service (at reduced operating conditions if necessary), while the new replacement pipe is being installed. Typically, methods of offline replacement include open cut excavation and newer trenchless methods such as directional drilling and microtunneling/pipe jacking. For microtunneling, FRP/GRP, polymer concrete, and steel pipes can be used.

Technology Selection Criteria

Aside from selecting renewal technologies on the basis of their fit to the force main's operating conditions (e.g., pressure, burial depth, etc.), other site-specific parameters must be considered in the selection process. The life-cycle cost of the renewal method and its impact on extending the life of the asset are often the primary concerns in technology selection. As discussed in this report, studies in the US and UK have shown the relative cost benefits of rehabilitation versus open cut replacement in urban environments. Other site-specific factors that should be taken into consideration include post-renewal capacity needs, accessibility, future operations and maintenance (O&M) requirements, the condition of the host pipe, and the consequence of its failure (criticality).

All rehabilitation options will result in a reduced cross-sectional area. Spray-on linings and close-fit liners will least impact flow capacity, while sliplining will have the greatest impact. Loss of capacity is mitigated somewhat by improved friction factors. If capacity restraints exist, then replacement may be the only feasible option.

Other items that can impact the selection of a renewal method are accessibility of the force main, maintenance crews familiarity with the liner system and repair methods, and the criticality of the force main. The higher the consequences associated with a failure, the more conservative the approach will be towards renewal of the main. A partially deteriorated force main that has an extremely high consequence of failure would be one that would probably be treated as fully deteriorated from the perspective of the design of the rehabilitation system.

Design and Quality Assurance/Quality Control

The design of a rehabilitation product to renew the life of a distressed sewer force main ranges from an inner corrosion barrier to an outright structural replacement. The factors that will control the design are the condition of the existing main, including its expected remaining life if further deterioration is arrested, and the operating conditions under which that main is used. The degree of deterioration is typically broken down into one of two categories: (1) *partially deteriorated*, where the existing pipe is expected to support all external loads (soil, live, surcharge), or (2) *fully deteriorated* where the existing pipe is not structurally sound.

Design methods currently employed are for either interactive or independent liners and depend upon the condition of the existing (host) pipe. Interactive liners are generally thin liners, in direct contact with the inside wall of the existing pipe, with a lower ring tensile stiffness than the existing pipe. Interactive liners should not be used in sewer force mains where the existing pipe has deteriorated to a point where it is not expected to be able to carry the full internal pressure over the renewal design life. An independent liner is one that is designed to carry the full internal working pressure and surge pressure itself independent of any contribution from the host pipe.

Few rehabilitation products are designed specifically for use in a sewer force main. Therefore, design and Quality Assurance/Quality Control (QA/QC) requirements and best practices may need to be adapted from relevant American Water Works Association (AWWA) and American Society for Testing and Materials (ASTM) standards.

The AWWA M28 Manual on Rehabilitation of Water Mains has established four classes of design: non-structural (Class I), semi-structural (Class II and III), and fully structural (Class IV). Class I liners only act as corrosion barriers, Class II/III liners are designed to bridge over small holes or gaps in the host pipe, while Class IV liners will carry the full internal pressure without support from the host pipe.

A whole host of ASTM specifications and AWWA standards cover the various types of materials and installation practices that may be used in a renewal project. Many of these are included in this report, along with a brief description. Some of the ASTM standards include non-mandatory design appendices, which are all patterned after Appendix X1 of ASTM F1216. ASTM F1216 is the standard practice for the rehabilitation of gravity and/or pressure pipes using a CIPP inversion product.

For gravity applications, the design appendix in ASTM F1216 requires that the liner be designed to support (without buckling) any external hydrostatic head if the host pipe is partially deteriorated and all external loads (without buckling) if fully deteriorated. Of course, the determination of whether the host pipe is partially or fully deteriorated is subjective. Likewise, depending on the ratio of the diameter of any holes in the pipe to the pipe diameter, the liner is designed to either act as a flat plate with fixed edges covering the hole or, if the host pipe is fully deteriorated, then as a thin ring under hoop stress from the internal pressure. In both of these design cases, either the long-term flexural strength or the long-term tensile strength is used. However, there is no standardized test method defined to determine either of these properties for a CIPP product. It is up to each manufacturer to establish those long-term properties. Based on a survey of CIPP producers, few if any have embarked on an extensive test program similar to that required for the pressure design of FRP/GRP or thermoplastic pipes.

Most of the QC requirements in the ASTM and AWWA standards pertain to use in a gravity sewer or a pressure water main. None combine the corrosion resistance necessitated by the sewer effluent and the long-term tensile strength of a pressurized main. Post-installation closed circuit television (CCTV) is the most common QC requirement for all liners followed by the retrieval of samples for physical property verification. Leak tightness testing is also recommended.

Operation and Maintenance

Some of the best practices for O&M are cleaning, addition of cathodic protection, installation of continuous corrosion monitoring, pressure monitoring, leak monitoring, and acoustic monitoring of prestressed concrete cylinder pipe (PCCP) for wire breaks. These measures can be effective in either prolonging the life of a buried sewer force main or allowing a utility to monitor real-time performance so action can be taken as needed to repair, rehabilitate, or replace before a catastrophic failure occurs.

Proper cleaning can improve the capacity and hydraulic performance of a sewer force main. Cathodic protection can arrest any further external electrochemical-induced corrosion of ferrous mains. Continuous corrosion monitoring can be installed on new mains or added to existing mains. Ultrasonic sensors measure loss of internal wall thickness. Leaks can be a precursor of failure and locating leaks in a force main using acoustic devices can help to prevent catastrophic failures.

A rehabilitated main effectively adds to the range of material that must be potentially repaired in an emergency. There are no set procedures for repair of rehabilitated (i.e., lined) force mains. This is an area of concern for utilities and certainly makes them reluctant to line their mains because they do not know how to deal with them when emergency repair becomes necessary.

Gaps Between Needs and Available Technologies

Little data are obtained on force main condition upon which assessment and subsequent rehabilitation decisions can be based. So rehabilitation decision-making is often based on operational indicators such as power consumption, air release valve operation, or main breaks. The renewal decision should be based on three elements: the rate of deterioration of assets; the condition of critical locations; and whether spending can be deferred. A first step is to establish risk-based assessment methods to identify force mains with serious consequences of failure, either in operational or environmental and public impact

terms, or both. A second step is to consider prioritization for external data collection. A method for identifying high risk locations in terms of likelihood of failure based on environment and operating characteristics could pinpoint high risk locations, which would be selected for direct inspection.

There is a clear need for assessment methodologies that can work with limited data. These could potentially be based on Bayesian belief networks. There is also a need for inspection technologies that can provide data more cost-effectively to support these assessment methodologies.

A gap exists in terms of a design procedure for CIPP in pressure applications to ensure that long-term performance requirements can be met. Little data are available on the long-term performance of rehabilitation solutions in real environments, which a designer can use to predict the remaining life of an asset that incorporates one of these rehabilitation methods. Another capability gap is the access needed to the main and the need to shut down, dewater, and clean the main for rehabilitation. This is an inevitable feature of any internal rehabilitation technology, as it is for inspection technologies. This also places a limitation on the use of rehabilitation in force mains.

Findings and Recommendations

Most of the renewal activity has been outright replacement of the force main either by open cut or trenchless means. New products and technologies are now emerging for carrying out a direct condition assessment on a buried force main, as well as rehabilitation methods for those found in distress.

One method of assisting owners in their efforts to apply some of these emerging technologies will be in the publication of demonstration projects and case studies. Also, setting up a decision support system that helps a utility ask the right questions so that a viable rehabilitation solution emerges is paramount.

It is clear that a system rehabilitation program needs to integrate several aspects and to have a broader vision than merely the rehabilitation technology and its implementation. The elements that need to be integrated within the scope of an asset management approach include inspection, assessment, maintenance, and rehabilitation.

Key elements of force main maintenance are regular cleaning, maintenance of cathodic protection systems, and maintenance of air release valves. Inclusion of corrosion monitoring, pressure monitoring, and leak monitoring should be considered.

The decision-making process relies on data from inspection to assess risk levels and to decide on necessary actions. Determining the level of data or information required to support effective decisions is a key aspect of the process. Too little data and the wrong decisions may be made; too much data and the cost of obtaining the data may exceed its value in the process. Neither scenario is cost-effective. One of the key data elements needed is verification of the long-term performance of pressure rehabilitation systems. This should be a major objective of the demonstration project.

CONTENTS

DISCLAIMER	ii
FOREWORD	iii
EXECUTIVE SUMMARY	iv
FIGURES	xii
TABLES	xiii
DEFINITIONS	xiv
ACRONYMS AND ABBREVIATION	xvi
1.0 INTRODUCTION	1
1.1 Project Background	1
1.2 Project Objectives.....	2
1.3 Project Approach.....	3
1.4 Organization of Report	3
2.0 CHARACTERISTICS OF FORCE MAIN SYSTEMS.....	5
2.1 Material Usage	5
2.2 Diameter Distribution.....	5
2.3 Age of System	7
2.4 Force Main Location	7
2.5 Redundancy	9
2.6 Cause of Failure in Force Mains	9
2.6.1 Ferrous Force Mains.....	9
2.6.2 Non-Ferrous Force Mains	9
3.0: RENEWAL PRACTICES AND TECHNOLOGIES	11
3.1 Current Utility Practices and Market.....	11
3.2 Overview of Renewal Technologies	12
3.3 Repair	14
3.3.1 Open Cut Emergency Replacement.....	14
3.3.2 Spot Repair – Trenchless.....	14
3.3.2.1 Cured-in-Place Pipe	14
3.3.2.2 Sleeve.....	15
3.3.2.3 External Repair Clamps	15
3.3.3 Joint Repair	16
3.3.3.1 Internal Joint Repair.....	16
3.3.3.2 External Joint Repair.....	16
3.4 Rehabilitation	17
3.4.1 Cleaning Requirements	17
3.4.2 Spray-on Linings	18
3.4.2.1 Cement Mortar Linings	18
3.4.2.2 Reinforced Mortar Linings.....	19
3.4.2.3 Epoxy Spray-on Linings	19
3.4.2.4 Polyurethane Spray-on Linings.....	20
3.4.2.5 Polyurea Spray-On Linings.....	21
3.4.3 Close Fit Lining Systems	22
3.4.3.1 Symmetrical Reduction Close Fit Lining – PE.....	24
3.4.3.2 Fold-and-Form Close Fit Lining – PE	26
3.4.3.3 Fold-and-Form Close Fit Lining – PVC (Alloy).....	28
3.4.4 Cured-In-Place Pipe	30

3.4.4.1	Non-Structural to Semi-Structural CIPP Liners.....	31
3.4.4.2	Semi-Structural CIPP Liners.....	32
3.4.4.3	Structural CIPP Liners	32
3.4.5	Woven Hose Lining System.....	35
3.4.5.1	Adhesive-Backed Woven Hose Lining.....	36
3.4.5.2	Non-Adhesive Backed Woven Hose Lining	37
3.4.5.3	Glass-Reinforced Thermoplastic Liner	38
3.5	Replacement	39
3.5.1	Online Replacement	40
3.5.1.1	Sliplining.....	40
3.5.1.2	Pipe Bursting.....	42
3.5.1.3	Pipe Slitting.....	44
3.5.2	Offline Replacement.....	44
3.5.2.1	Open Cut	44
3.5.2.2	Directional Drilling	44
3.5.2.3	Microtunneling/Pipe Jacking	44
4.0:	TECHNOLOGY SELECTION CONSIDERATIONS	46
4.1	Life-Cycle Costs.....	46
4.2	Capacity.....	48
4.3	Accessibility	48
4.4	Maintenance	49
4.5	Condition Assessment and Asset Criticality	49
5.0:	DESIGN AND QA/QC.....	52
5.1	System Design.....	52
5.1.1	Redundancy in System Design.....	52
5.1.2	Pig Launchers/Retrieval for Cleaning and Inspection.....	52
5.2	Renewal Design.....	53
5.2.1	Degrees of Deterioration	53
5.2.2	Interactive vs. Independent.....	54
5.2.3	Design Loads.....	54
5.2.4	Other Considerations.....	56
5.3	Product/Material Standards	56
5.4	Design Standards.....	59
5.4.1	Design of Pressure Systems	61
5.4.1.1	Partially Deteriorated Case	61
5.4.1.2	Fully Deteriorated Case	63
5.5	Installation Standards	64
5.6	QA/QC Requirements	67
5.6.1	Short-Term – Factory and Field Requirements.....	67
5.6.1.1	PVC Short-Term QA/QC Requirements.....	67
5.6.1.2	PE Short-Term QA/QC Requirements.....	68
5.6.1.3	CIPP Short-Term QA/QC Requirements	68
5.6.2	Long-Term – Qualification Requirements	69
5.6.2.1	PVC Long-Term QA/QC Requirements.....	69
5.6.2.2	PE Long-Term QA/QC Requirements	69
5.6.2.3	CIPP Long-Term QA/QC Requirements	70

6.0: OPERATION AND MAINTENANCE	71
6.1 Procedures to Prolong the Life of Existing Force Mains	71
6.1.1 Cleaning	71
6.1.2 Cathodic Protection	73
6.1.3 Continuous Corrosion Monitoring	74
6.1.4 Pressure Monitoring	75
6.1.5 Leak Monitoring.....	76
6.1.6 Acoustic Monitoring for Wire Breaks in PCCP	76
6.2 Maintenance and Emergency Repair of Rehabilitation Systems.....	77
7.0: GAPS BETWEEN NEEDS AND AVAILABLE TECHNOLOGIES.....	78
7.1 Data Gaps	78
7.2 Capability Gaps	79
7.3 Benefits, Costs and Challenges in Closing Gaps.....	79
8.0: FINDINGS AND RECOMMENDATIONS.....	81
8.1 What Systems Would Benefit Most from Being Demonstrated in Field Settings?.....	81
8.2 Key Parameters for Evaluation in Demonstration Projects	81
8.3 Guidance for Establishing a Comprehensive System Rehabilitation Program	83
8.4 Guidance for Maintenance Programs	83
8.5 Sound, Risk-Based, Decision-Making Process Development.....	84
8.6 Cost-Effectiveness of Decision-Making Processes	84
8.7 Timing for Rehabilitation Action	84
8.8 Demonstration/Verification of Pressure System Rehabilitation.....	85
9.0: REFERENCES	86

FIGURES

Figure 2-1. Pipe Material Usage for Sewer Force Mains	5
Figure 2-2. Diameter Distribution of Sewer Force Mains	6
Figure 2-3. Age of Force Mains.....	7
Figure 2-4. Location of Force Mains	8
Figure 2-5. Land Development over Buried Force Mains	8
Figure 2-6. Causes of Failure in Ferrous Force Mains	10
Figure 2-7. Causes of Failure in Non-Ferrous Sewer Force Mains	10
Figure 3-1. Renewal Approaches for Force Mains.....	11
Figure 3-2. Repair Approaches for Force Mains	14
Figure 3-3. Link-Pipe 12 inch Pressure-Seal	15
Figure 3-4. Romac SS2 Repair Clamp.....	15
Figure 3-5. AMEX 10 Mono Seal.....	16
Figure 3-6. Rehabilitation Approaches for Force Mains	17
Figure 3-7. Summary of Spray Lining Technologies	18
Figure 3-8. Typical Stress Strain Curve for Ferrocement.....	19
Figure 3-9. Summary of Close Fit PE Technologies	23
Figure 3-10. PE Close-Fit Liner Hole Spanning Capabilities.....	23
Figure 3-11. Roller Reduction Unit for PolyFlex	25
Figure 3-12. Illustration of PE Pipe Compression	25
Figure 3-13. Summary of Fold-and-Form Close Fit Lining Technologies.....	26
Figure 3-14. Relationship Between Diameter and SDR for Folding	28

Figure 3-15.	Subline Forming into “C” Shape.....	28
Figure 3-16.	PolyFold™ Banding.....	28
Figure 3-17.	Summary of CIPP Technologies.....	31
Figure 3-18.	Starline® 1000.....	36
Figure 3-19.	Aqua-Pipe Construction.....	36
Figure 3-20.	Aqualiner Installation Process.....	38
Figure 3-21.	Summary of Replacement Technologies.....	40
Figure 3-22.	Fusion of PVC Joint.....	41
Figure 3-23.	Hobas Sliplining Pressure Joint.....	42
Figure 3-24.	Static Bursting Head.....	43
Figure 3-25.	Pneumatic Bursting Head.....	43
Figure 3-26.	Permalok T7 Pressure Joint.....	45
Figure 4-1.	Total Installation Cost in 2003 Dollars for Trenchless Rehabilitation Methods.....	46
Figure 4-2.	UK Water Rehabilitation Costs.....	47
Figure 4-3.	Belief Network for Risk of Failure in PCCP.....	51
Figure 4-4.	Belief Network for Consequences of Failure in PCCP.....	51
Figure 6-1.	Polyurethane Pipeline Cleaning Pigs.....	72
Figure 6-2.	LPR Ferguson-Nicholas Cell.....	75

TABLES

Table 2-1.	Percentage of Materials by Diameter Range.....	6
Table 3-1.	Summary of Renewal Technologies with Applicability to Force Mains.....	13
Table 3-2.	Summary of Internal Joint Vendors.....	16
Table 3-3.	Properties of Hunting Polyurea Spray-on Linings.....	22
Table 3-4.	Pressure Class of PE 3408 based on AWWA C906 at 80 °F.....	24
Table 5-1.	ASTM Material Standards for PVC Pipe.....	57
Table 5-2.	ASTM Material Standards for PE Pipes.....	57
Table 5-3.	ASTM Material Standards for CIPP.....	58
Table 5-4.	ASTM Standards for FRP/GRP.....	59
Table 5-5.	Design Standards for PVC Materials.....	59
Table 5-6.	Design Standards for Polyethylene Materials.....	59
Table 5-7.	Design Standards for Glass-Reinforced Thermosetting Plastic Pipe.....	60
Table 5-8.	ASTM Design Standards for CIPP Materials.....	60
Table 5-9.	ASTM Installation Standards for PVC Materials.....	64
Table 5-10.	ASTM Installation Standards for FRP/GRP Materials.....	64
Table 5-11.	ASTM Installation Standards for Polyethylene Materials.....	65
Table 5-12.	ASTM Installation Standards for CIPP Materials.....	65
Table 5-13.	Minimum Structural Properties of CIPP Products by ASTM F1216.....	66
Table 5-14.	Minimum Structural Properties of CIPP Products by ASTM F1743.....	66
Table 5-15.	Minimum Structural Properties of CIPP Products by ASTM F2019.....	67
Table 5-16.	ASTM D5813 Chemical Solution Specifications.....	70
Table 7-1.	Technology Gaps and Closure Costs and Benefits.....	80
Table 8-1.	Parameters for Evaluation in Demonstration Projects.....	82

DEFINITIONS

Cured-in-place pipe (CIPP) – a hollow cylinder consisting of a polyester and/or glass reinforced plastic fabric tube with cured thermosetting resin. The CIPP is formed within an existing pipe and takes the shape of the pipe.

Folded pipe – pipe that has been manufactured and calibrated round, then subsequently cooled and deformed into a folded shape for insertion into the existing pipe.

Force main – a pipe that transports raw sewerage and operates under pressure.

Formed pipe – a folded pipe that has been inserted into an existing pipe and expanded with steam heat and pressure, and, if required by the manufacturer, with a squeegee device or “pig” to provide a close fit to the existing pipe.

Hydrostatic design basis (HDB) – a long-term hoop tensile stress when applied to the pipe or liner continuously for the specified time period (usually 100,000 or 438,000 hours) will result in failure of the pipe or liner.

Partially deteriorated pipe – the existing pipe can support the soil and surcharge loads throughout the design life of the rehabilitated pipe and the soil adjacent to the existing pipe must provide adequate side support.

Fully deteriorated pipe – the existing pipe is not structurally sound and cannot support soil and live loads or is expected to reach this condition over the design life of the rehabilitated pipe. This condition is evident when sections of the existing pipe are missing, the existing pipe has lost its original shape, or the existing pipe has corroded due to the effects of the fluid, atmosphere, or soil.

Non-structural – provides no load-bearing capacity to the pipe; primarily acts as a corrosion barrier.

Open cut – the use of excavation to install a new pipe or replace an existing one.

Rehabilitation – internal coatings, sealants, and linings used to extend operational life and restore much or all of the pipe’s hydraulic and structural functionality.

Renewal – improving the structural performance, flow capacity, corrosion resistance or water quality of a deteriorated pipe by repair, rehabilitation, or replacement

Repair – used when the existing pipe is structurally sound, provides acceptable flow capacity, and can serve as the support or host of the repair method.

Replacement – an existing pipe is usually replaced when it is severely deteriorated, collapsed, or increased flow capacity is needed.

Semi-structural – a liner whose long term internal burst strength is less than the maximum allowable operating pressure of the pipeline to be rehabilitated. Semi-structural liners are capable of bridging holes and gaps in the host pipe.

Sliplining – the installation of a smaller diameter replacement pipe inside an existing pipe leaving an annular gap between the two. The replacement pipe can be continuous or made up of discrete segment lengths.

Structural – a liner whose long-term internal burst strength equals or exceeds the maximum allowable operating pressure of the pipeline to be rehabilitated.

Trenchless – the installation of a new pipe or liner with minimal or no excavation required.

UNIT CONVERSION FACTORS

1 meter = 3.2808 feet

1 km = 0.62 mile

1 millimeter = 0.03937 inch

$^{\circ}\text{F} = 1.8(^{\circ}\text{C}) + 32$

MPa = 145 psi

1 bar = 14.503 psi

Psig = psi + 14.7

mm = 39.37 mil

1 mile = 1.609 km

1 US\$ = 0.748 Euro

ACRONYMS AND ABBREVIATION

3-D	three-dimensional
AASHTO	American Association of State Highway and Transportation Officials
ACP	asbestos cement pipe
AREA	American Railway Engineering Association
ASCE	American Society of Civil Engineers
ASTM	American Society of Testing and Materials
AWWA	American Water Works Association
AWWARF	American Water Works Association Research Foundation (Now known as the Water Research Foundation)
BEM	broadband electromagnetic
CCP	concrete cylinder pipe
CCTV	close circuit television
CI	cast iron
CIPP	cured-in-place pipe
DI	ductile iron
DIPS	ductile iron pipe size
DOT	Department of Transportation
DR	diameter ratio
DSAW	double submerged arc welded
DWI	Drinking Water Inspectorate
EPA	U.S. Environmental Protection Agency
EPB	earth pressure balance
EPDM	ethylene propylene diene M-class
ESCR	environmental stress crack resistance
FRP	fiberglass reinforced pipe
GBR	Geotechnical Baseline Report
GDSR	Geotechnical Design Summary Report
GRP	glass reinforced plastic
GTI	Gas Technology Institute
H ₂ S	hydrogen sulfide
HCl	hydrochloric acid
HDB	hydrostatic design basis
HDD	horizontal directional drilling
HDPE	high density polyethylene
HDS	hydrostatic design stress
HPL	high pressure liner
H ₂ SO ₄	sulfuric acid

ID	inner diameter
IJS	intermediate jacking stations
IPLT	International Pipe Lining Technologies
IPS	iron pipe size
ISO	International Organization for Standardization
kN	kilo Newton
LPR	linear polarization resistance
MDPE	medium density polyethylene
MFL	magnetic flux leakage
MOP	manual of practice
NASSCO	National Association of Sewer Service Companies
NRC	National Research Council, Canada
NRMRL	National Risk Management Research Laboratory
NSF	National Sanitation Foundation
O&M	operation and maintenance
OD	outer diameter
OFWAT	Office of Water Service
PCCP	prestressed concrete cylinder pipe
PE	polyethylene
PIPP	pulled-in place pipe
PPI	Plastic Pipe Institute
PPIC	Pressure Pipe Inspection Company
PPL	pressure pipe liner
psi	pounds per square inch
PU	polyurethane
PVC	polyvinyl chloride
PVCO	molecularly-oriented polyvinyl chloride
QA	quality assurance
QC	quality control
RBI	Risk-Based Investigation
RCP	reinforced concrete pipe
RPL	reinforce pressure line
RPP	reinforced pressure pipe
SDR	standard dimension ratio
SIPP	spray-in place pipe
SOT	state-of-the-technology
TBM	tunnel boring machine
TIM	Tenbusch Insertion Method
TO	task order
TTC	Trenchless Technology Center
UL	Underwriters Laboratory

UV ultraviolet

WERF Water Environment Research Foundation
WRc Water Research Center, UK

1.0 INTRODUCTION

Force mains that carry sewage flows under pressure represent a special set of challenges for sewer rehabilitation. Force mains represent about 7.5% of the wastewater system and they typically use materials that are not commonly used in gravity sewer systems. Ductile iron (DI), cast iron (CI), steel, and concrete pressure pipe are all material types frequently used for sewer force mains, especially in larger diameters. All of these materials are susceptible to both internal corrosion from the sewer flow (liquid and gaseous states), as well as external corrosion due to the environment in which the pipe is buried.

Redundancy is not common with sewer force mains so most run constantly and can only be taken out of service for brief periods lasting a few hours at best. Consequently, little internal inspection of force mains is undertaken so the condition of many is largely unknown. It has only been in the past few years that some utilities have started to develop programs for inspecting their underground force mains as part of an overall asset management strategy. Many of these are a direct result of a consent decree.

Once a force main is inspected and its condition ascertained, a decision must be made on the next appropriate step. If the condition is found to be good, scheduling another inspection in 10 to 15 years might be appropriate. Force mains that are found to be failing or near failing should be candidates for immediate renewal, especially those that are critical assets with significant negative consequences associated with a failure. Historically, the most common renewal technology employed has been to replace the main using open cut construction. Part of the reason for that choice has been a lack of rehabilitation technologies appropriate for sewer force mains. There is a wealth of technologies for gravity sewers, but the field has been limited for pressurized systems. Fortunately, that situation is changing as more vendors recognize the growing opportunity in sewer force main rehabilitation. The other reason for replacement is that sewer force mains tend to have a fairly high consequence of failure. A rupture of a sewer force main could release millions of gallons of raw sewage into the environment posing significant health risks to the general public. Cleanup costs can be staggering. Therefore, the tendency when it comes to considering renewal of a force main is to err on the conservative side and go with outright replacement.

As some of the newer rehabilitation technologies develop a positive track record of use in sewer force mains and confidence in their design approach and installation process strengthens, more utilities will be willing to consider these trenchless technologies as potential renewal solutions. This is especially true if the rehabilitation technology is significantly cheaper than replacement with open cut construction. The gap between funds needed to restore the integrity of the underground infrastructure to an acceptable level of reliability and available funds is widening. One way to close the gap is to find more cost-effective methods of rehabilitation than open cut replacement. Trenchless methods have proven themselves to be cost-effective for gravity sewer mains, especially when both direct and indirect costs associated with a replacement program are considered. A similar outcome is expected for sewer force mains once data on the effectiveness and longevity of these technologies and materials and life-cycle cost information become more readily available. This state-of-the-technology (SOT) report will begin to address those needs.

1.1 Project Background

This report was prepared as part of the research being conducted under the U.S. Environmental Protection Agency's (EPA's) Sustainable Water Infrastructure Initiative. Under this program, research is being conducted to improve and evaluate innovative technologies that can reduce costs and increase the effectiveness of the operation, maintenance, and renewal of aging drinking water distribution and

wastewater conveyance systems (EPA, 2007). The outputs from this research program are intended to assist EPA's program and regional offices to implement Clean Water Act and Safe Drinking Water Act requirements; to help states and tribes meet their programmatic requirements; and to assist utilities to more effectively implement comprehensive management of drinking water and wastewater treatment and conveyance systems. This initiative is aimed at encouraging the introduction of new and improved technologies into the US marketplace for water and wastewater rehabilitation, which will aid utilities in providing reliable service to their customers and meeting their statutory requirements. As part of this research effort, the EPA National Risk Management Research Laboratory (NRMRL) awarded Task Order No. 58 titled *Rehabilitation of Wastewater Collection and Water Distribution Systems* under Contract No. EP-C-05-057. This research project includes the preparation of a series of reports on the State Of Technology in rehabilitation of sewer force mains, water mains, and gravity wastewater systems (mains, laterals, and manholes). This report presents a comprehensive review and evaluation of existing and emerging technologies to define the current state-of-the-practice and state-of-the-art for sewer force main renewal. The report seeks to address some of the following questions posed in the EPA's *Innovation and Research for Water Infrastructure for the 21st Century Research Plan* (EPA, 2007):

- Can emerging and innovative force main rehabilitation technologies be identified and demonstrated in field settings to improve the understanding of their cost-effectiveness, technical performance, and reliability?
- Can approaches and methods be developed for determining the long-term performance and life-cycle cost-effectiveness of various force main rehabilitation systems?
- Can system design guidance based on lessons learned from rehabilitation be developed to enhance long-term performance and system integrity and to allow for easier inspection, maintenance, and rehabilitation?
- Can guidance be provided for operation and maintenance (O&M) programs, including procedures to assess and optimize maintenance practices that reduce the need for rehabilitation?
- Can a sound, risk-based, decision-making process for selecting optimal system rehabilitation technologies and methods be developed based on long-term effectiveness, system performance, structural integrity, consequence of failure, and life-cycle cost?
- Are decision-making processes for selecting optimal system rehabilitation technologies and methods cost-effective, and do they adequately address relevant factors (e.g., long- and short-term performance, cost, hydraulic effects, structural integrity, condition assessment, maintenance, and consequence of failure)?

1.2 Project Objectives

The objective of this report is to provide a comprehensive review of the US market with respect to rehabilitation of sewer force mains. The main portion of the report is a review of all known technologies that could be utilized in the rehabilitation of sewer force mains. Some of these technologies have not yet been used for this purpose, so one is cautioned to not only read the text in the report, but also the relevant technology-specific datasheets listed in Appendix A for more details. The report includes a discussion of what technologies exist for rehabilitating a partially versus fully deteriorated force main. It also includes a discussion on the current design methodologies for semi-structural conditions (designed to only bridge over small holes or gaps in a main) and fully structural conditions (designed to carry the full internal pressure and external loads).

Gaps between what's available versus what's needed have also been identified in this report. Clearly the biggest need would be for a fully structural liner that could be installed in a live sewer. Achieving that is unlikely, at least in the next decade, but many other gaps are being closed. For example, vendors are embarking on more long-term testing programs to help document the performance of their liners in a pressurized system so that they can be designed for a minimum 50-year design life.

1.3 Project Approach

There are technologies that can be used in multiple applications. Sewer force mains have similar design characteristics to water mains. Both must carry working and surge pressures of the system and are generally buried only 4 to 8 feet (1.2 to 2.5 meters), so both are subjected to live loads in addition to trench loads. Water mains carry potable water so their influence on water quality is important, which is not the case with a sewer force main. However, the effluent carried in a force main is far more corrosive than potable or raw water, especially where gas pockets develop, so a force main must have the same corrosion resistant characteristics as a gravity sewer. Consequently, some technologies that are suitable for sewer force mains, providing they also are certified to meet National Sanitation Foundation (NSF) 61, would also be applicable for a water main. Also, some technologies that are used to line a gravity sewer can also be used in a low pressure force main.

Recognizing that there would be some cross-over amongst the various technologies, a series of technology-specific datasheets was created for each identified rehabilitation technology that is relevant to sewer force mains. These technology profiles are included as Appendix A of this report. This information was gathered by researching the technology (through published literature, Web sites, trade shows, case studies, and magazine articles) and completing the technology-specific datasheet as much as possible with publicly-available information. Each datasheet was then sent to the vendor to review and comment on the contents and to provide additional information as needed. As discussed in Section 4, an effort was made to collect representative cost information, but often only limited cost data were available.

1.4 Organization of Report

The report is organized according to the following subjects:

- Section 1: Introduction – project background
- Section 2: Characteristics of Force Main Systems – materials used, diameters and age distribution, and typical failure modes and mechanisms
- Section 3: Renewal Practices and Technologies – current utility practices and renewal market including an overview of repair, rehabilitation, and replacement technologies applicable to force mains
- Section 4: Technology Selection Considerations – life-cycle costs, capacity limitations, accessibility, maintenance, asset condition, and asset criticality are all factors to consider in the selection of the most appropriate renewal strategy
- Section 5: Design and Quality Assurance/Quality Control – system design and renewal design, product and installation standards, design standards, short-term and long-term testing requirements, and field QA/QC practices
- Section 6: Operation and Maintenance – procedures to prolong the life of a force main, including cleaning, cathodic protection, monitoring, and other maintenance considerations
- Section 7: Gaps Between Needs and Available Technologies – data and capability gaps, key parameters for evaluation in demonstration project

- Section 8: Findings and Recommendations – an overall summary of the key findings of the research
- Appendix A: Datasheets for rehabilitation technologies

2.0 CHARACTERISTICS OF FORCE MAIN SYSTEMS

It is important to understand the characteristics of force main systems and the typical failure modes and mechanisms in order to evaluate the most appropriate renewal technologies. The approximate length of the force main system in the US is 60,000 miles. The Water Environment Research Foundation (WERF) recently published a report titled *Guidelines for the Inspection of Force Mains* (WERF, 2009). As part of this effort, Jason Consultants conducted an electronic survey of all WERF utility subscriber members. Over 32 utilities responded to the survey with detailed data on their force main systems. The data from this WERF survey are presented in the next few sections and characterizes the types of pipe materials used, diameter ranges, ages, location accessibility, and failure modes and mechanisms for force mains determined from field data.

2.1 Material Usage

Figure 2-1 shows the breakdown by pipe material type. DI pipe is the predominant material, representing 47.3% of the total. Ferrous pipe materials (i.e., CI, DI, and steel) represent on average 63.4% of all pipes used for force mains. Polyvinyl chloride (PVC) pipe at 14.3% is the next largest category of pipe material. Also, it can be seen that pre-stressed concrete cylinder pipe (PCCP) is used for 11.6% of sewer force mains, this being predominantly in diameters 24 inches (600 mm) and above.

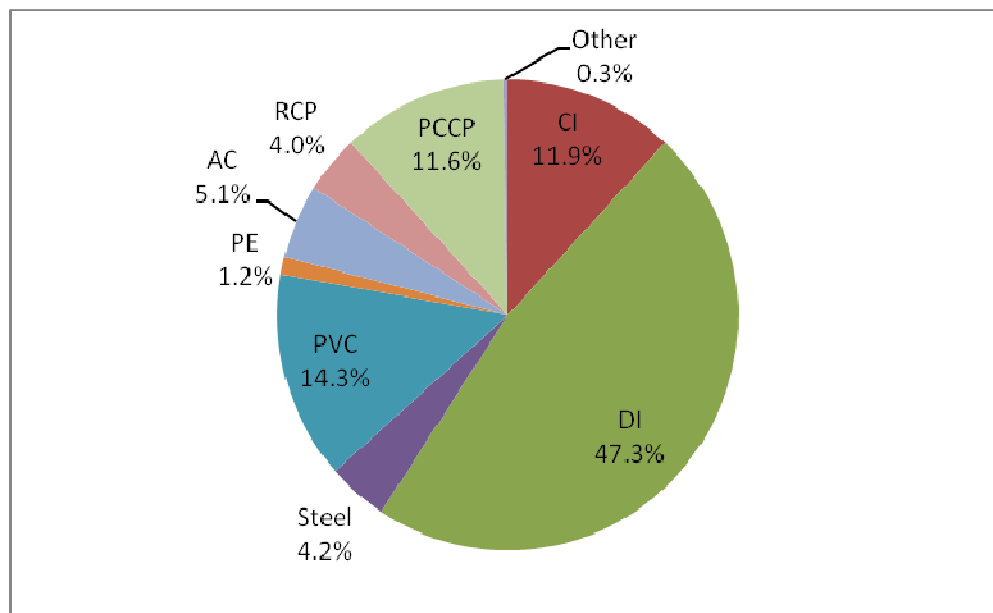

Figure 2-1. Pipe Material Usage for Sewer Force Mains (WERF, 2009)

2.2 Diameter Distribution

For a breakdown by diameters, as shown in Figure 2-2, approximately 46.6% of all sewer force mains fall into the diameter range 4 to 12 inches (100 to 300 mm). Another 22.7% is in the diameter range 14 to 20 inches (350 to 500 mm) and 22.2% in the diameter range 21 to 36 inches (525 to 900 mm). Over 91% of sewer force mains are between 4 and 36 inches (100 to 900 mm) diameter, which are within the non-man entry size range.

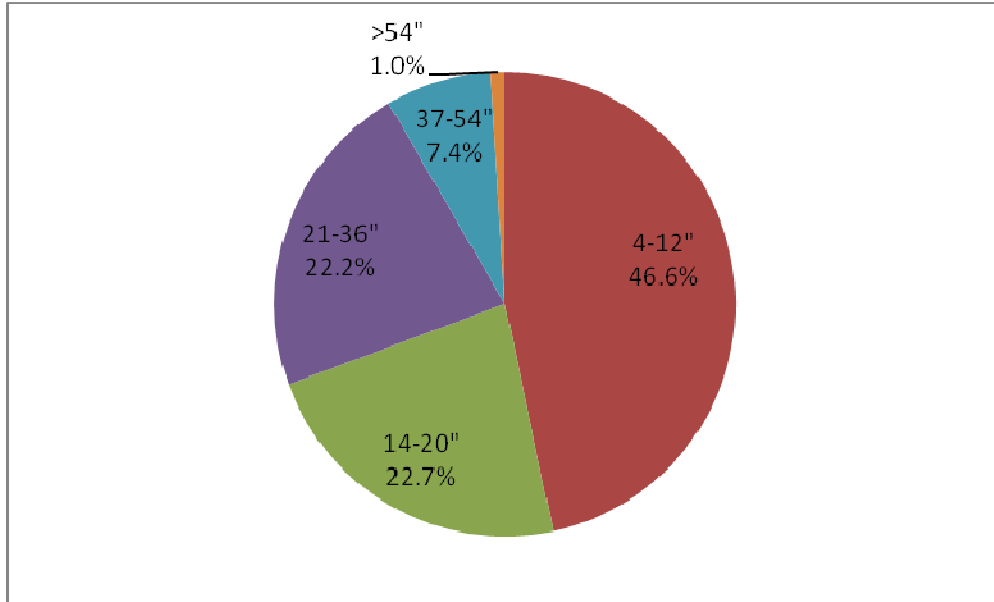

Figure 2-2. Diameter Distribution of Sewer Force Mains (WERF, 2009)

Figures 2-1 and 2-2 show the overall breakdown of materials and diameters. However, the distribution of materials varies significantly by diameter range. Table 2-1 shows the percentages of each material in each diameter range.

Table 2-1. Percentage of Materials by Diameter Range (WERF, 2009)

Material	4 12 inches	14 20 inches	21 36 inches	37 54 inches	>54 inches
DI	46.8%	62.5%	46.0%	13.9%	3.1%
CI	16.9%	12.7%	5.3%	<0.1%	0%
PVC	28.4%	3.5%	0.9%	0.1%	0%
HDPE	2.0%	1.0%	0.2%	0%	0%
PCCP/CCP	1.0%	3.1%	26.1%	54.6%	58.1%
Steel	0.5%	2.0%	10.3%	12.9%	30.4%
FRP	0%	0.1%	0%	0%	0%
ACP	4.0%	12.2%	0.7%	5.0%	0%
RCP	<0.1%	2.5%	10.4%	13.4%	8.4%
Other/Not Known	0.4%	0.5%	0.1%	0.1%	<0.1%
Totals	100%	100%	100%	100%	100%

Note: DI = ductile iron; CI = cast iron; PVC = polyvinyl chloride; HDPE = high density polyethylene; PCCP = pre-stressed concrete cylinder pipe; CCP = concrete cylinder pipe; FRP = fiberglass reinforced pipe; ACP = asbestos cement pipe; and RCP = reinforced concrete pipe

The data in Table 2-1 show clearly that DI and PVC dominate up to 12 inches (300 mm) in diameter. Over 93% of all PVC is in this range. DI is even more dominant in the 14 to 20 inch (350 to 500 mm) range, followed by CI, and then asbestos cement. It remains the main material in the 21 to 36 inch (525 to 900 mm) range, but PCCP is the next most used material in this range, followed by reinforced concrete pipe (RCP), and steel. CI and plastics including polyethylene (PE) and PVC are less widespread in this size range. PCCP is by far the main material used above 36 inches (900 mm) in diameter, with steel also representing a significant proportion of pipe.

2.3 Age of System

In contrast to the nation's water supply and gravity sewer systems, the use of force mains to convey sewage is relatively recent. As depicted in Figure 2-3, 68% of the force mains in use today have been in service for 25 years or less. Another 30% have been in service between 25 and 50 years and only 2% beyond 50 years. Other data sources gave similar results in terms of the age distribution of force mains. Typically no more than 2% is greater than 50 years old. This contrasts sharply with the water supply sector in which the average age of water mains in the US is now 45 years with nearly half of pipes aged more than 50 years old.

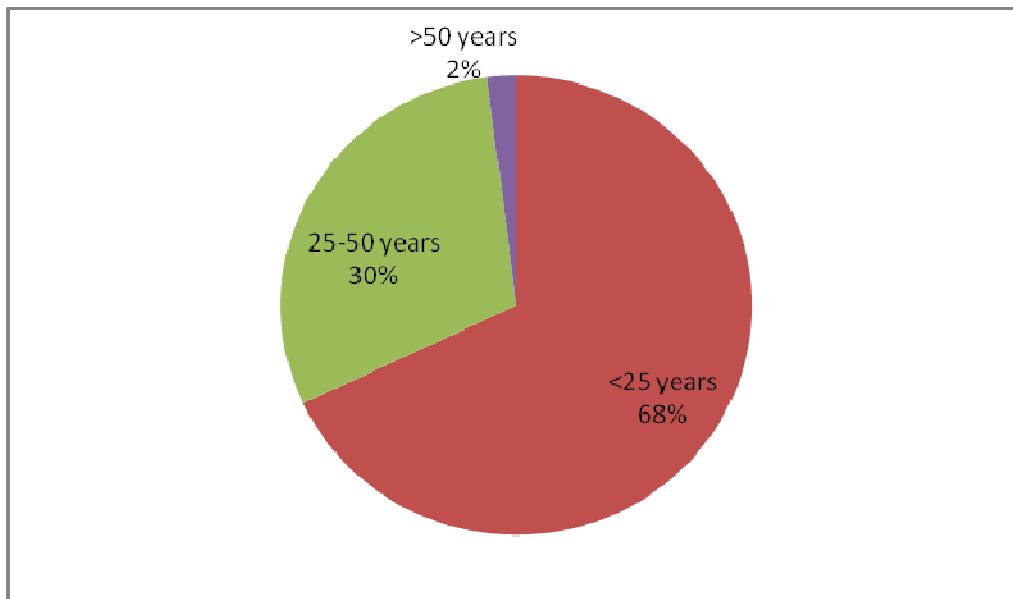

Figure 2-3. Age of Force Mains (WERF, 2009)

2.4 Force Main Location

This information might be important in evaluating the accessibility to the external surface of the pipe. As shown in Figure 2-4, over 91% of the force main pipes are buried, so access to the exterior surface will require some form of excavation. Less than 1% is installed above ground where access would be easier and less costly to achieve. A slightly larger percentage, approximately 1.2%, is installed sub-aqueously where access will be the most difficult.

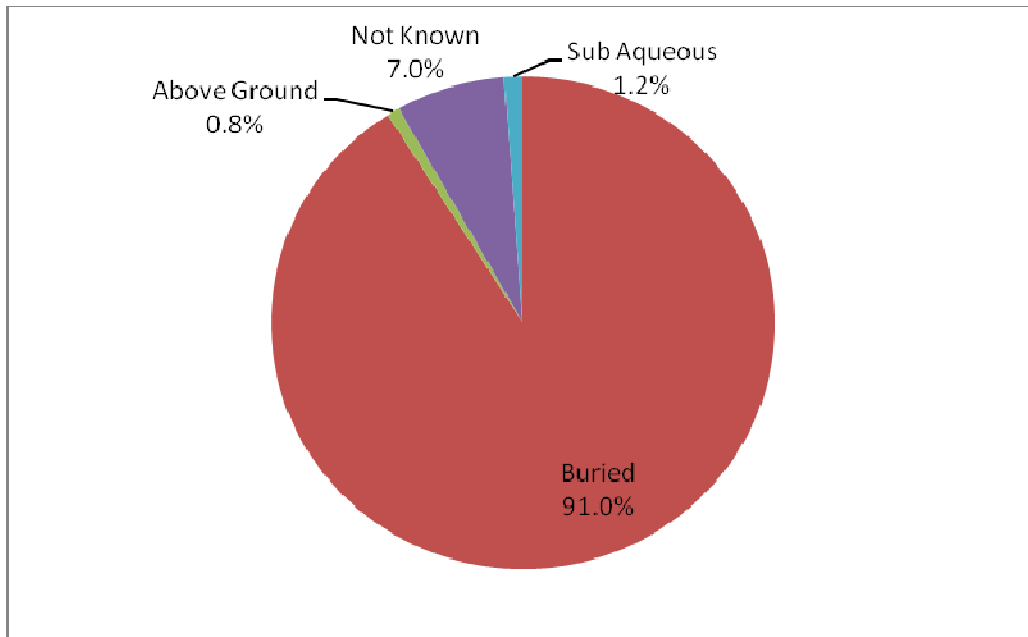

Figure 2-4. Location of Force Mains (WERF, 2009)

As shown in Figure 2-5, 66% of the footage of buried force mains lies under undeveloped land, but 21% of the buried footage would require removal of paved surfaces (asphalt or concrete). A location under paved surfaces would imply some degree of disruption to traffic (road and pedestrian) for excavation.

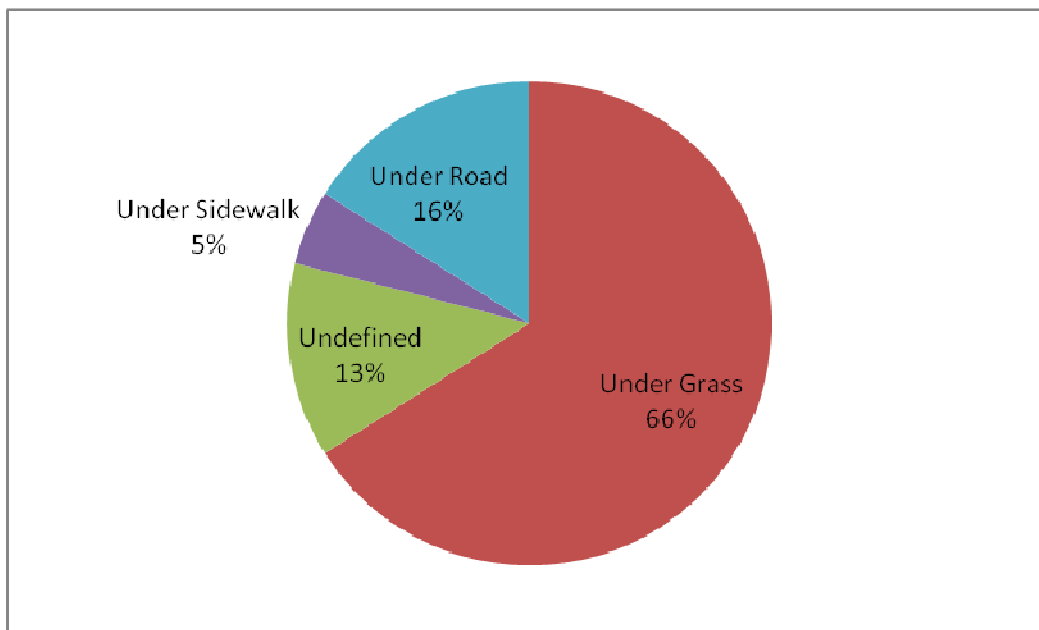

Figure 2-5. Land Development over Buried Force Mains (WERF, 2009)

2.5 Redundancy

Many force mains are located at critical points in sewerage systems. As a result, if they have to be taken out of service due to a failure, then by-pass pumping or the use of honey trucks is necessary. One way in which utilities plan for this is to install dual parallel force mains thus providing redundancy. During an emergency, such as a failure in one line, the parallel line can be used to maintain a minimal level of flow such that any upstream wetwell does not overflow or sewers become surcharged, or at least the use of honey trucks (required to keep the sewage from swamping any lift stations) is minimized. The other advantage in having a redundant line is the ability to take one line out of service for an intrusive (internal) inspection and/or repairs.

Over 45% of utilities contacted indicated that they had at least one redundant force main in their system. For those reporting in the affirmative, an average of 14% of the systems had some redundancy built in. However, some utilities actually reported in the WERF survey having a larger number of redundant systems than total force mains so this number is suspect. This limited sampling would suggest that perhaps about 5% of the total number of force mains do have some redundancy built in.

Parallel mains to enable one main to be out of service are seldom installed. Those utilities that do have parallel mains generally installed them because extra capacity was needed over and above that available from an existing main. The parallel main is then installed to provide additional capacity and not the total capacity. Thus, the opportunity for redundancy and operational security is not taken.

Current practice is not to install parallel mains to provide redundancy. Installing alongside existing mains considered critical is done only very occasionally.

2.6 Cause of Failure in Force Mains

Based on the WERF survey, almost universally, with 92% of the responders in the affirmative, utilities attempt to identify the cause of the failure in the force main. The utilities were asked to identify the most common factors relating to failures in their force mains. Various causes are discussed below. It is important to understand the typical failure modes and mechanisms of force mains in order to select the most appropriate repair, rehabilitation, and replacement technologies.

2.6.1 Ferrous Force Mains. Figure 2-6 shows that internal corrosion was rated as being responsible for ferrous force main failures 26.2% of the time, ahead of all other known causes. External corrosion at 19.2% and third-party damage at 19.4% are the next most common causes of failures. Combining internal and external corrosion, corrosion appears responsible for failures in force mains in nearly 46% of cases. After third-party damage, joint leakage at 15.2%, surge pressure at 10.2%, and insufficient capacity at 9.8% are the next most significant causes of force main failures.

2.6.2 Non-Ferrous Force Mains. Figure 2-7 shows the most common single cause of failure in non-ferrous force mains is third-party damage, which accounts for 36% of failures. Corrosion and structural failure together account for 54% of failures. It is considered likely that some of the structural failures reported for cementitious pipes (AC, RCP, and PCCP) are due to corrosion. Figure 2-7 is based on a weighted average of failure causes for each pipe material. The main causes of failure vary significantly by pipe material. For each pipe material type, the main causes of failure are as follows: (1) PVC – third-party damage, (2) PCCP – corrosion, (3) RCP – corrosion, (4) AC – third-party damage, and (5) PE – third-party damage.

Proper inspection of force mains would allow a utility to identify signs of corrosion and leakage, which represent 61% of the reported causes of failure in ferrous mains and 30% in non-ferrous mains. For example, with information on remaining wall thickness of ferrous mains, a utility could plan on repair, rehabilitation, or replacement before a force main fails. No amount of inspection can eliminate third party damage, which is the second leading cause of failure overall and the leading cause in non-ferrous mains. However, utilities can be prepared with proper emergency repair procedures in place.

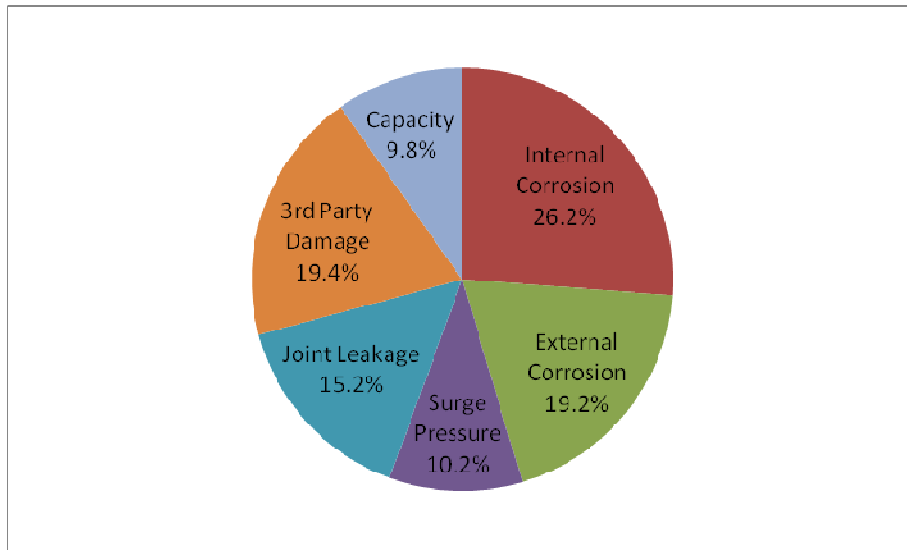

Figure 2-6. Causes of Failure in Ferrous Force Mains (WERF, 2009)

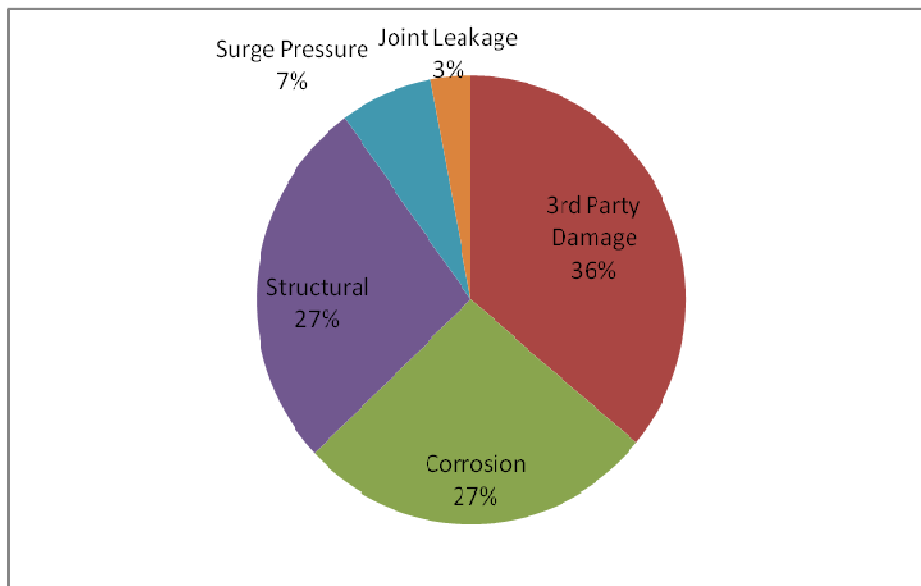

Figure 2-7. Causes of Failure in Non-Ferrous Sewer Force Mains (WERF, 2009)

3.0 RENEWAL PRACTICES AND TECHNOLOGIES

This section covers current utility practices as well as a review of existing and emerging renewal technologies for restoring structural and/or flow capacity to a distressed force main. As shown in Figure 3-1, the renewal of force mains includes repair, rehabilitation, and replacement. The simplest form of renewal is a spot repair, usually implemented on a reactive basis to a failure. More extensive renewal technologies are rehabilitation (using the existing fabric of the force main pipe) and replacement (installing an entirely new independent pipe). This new pipe can be installed offline using a different line or online using the same line and grade of the existing pipe. Both offline and online replacement can involve trenchless technologies.

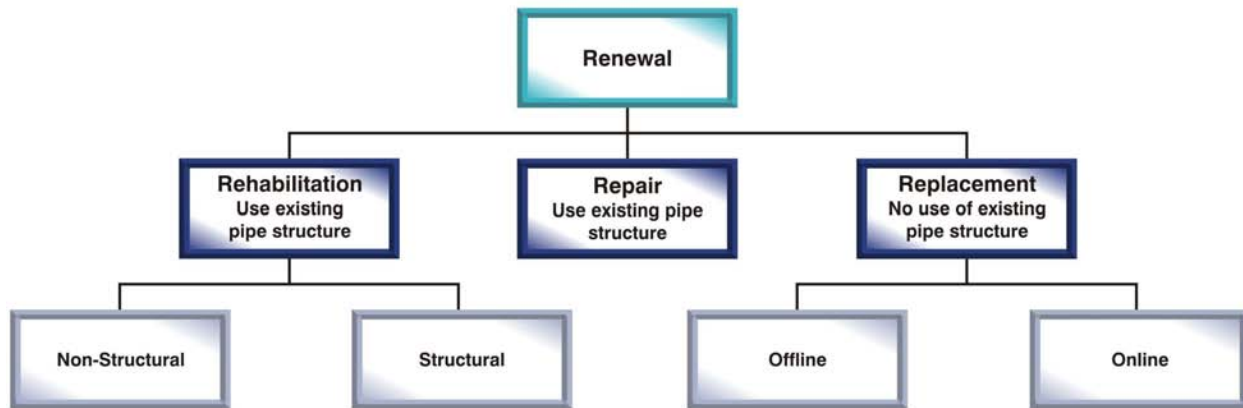

Figure 3-1. Renewal Approaches for Force Mains

3.1 Current Utility Practices and Market

The estimate of renewal works in force mains are between 250,000 and 600,000 linear feet (76,220 and 182,927 meters) or 0.08% to 0.19% of the total length on an annual basis. While this is significantly less than the proportion for gravity sewers, force mains are in general not as old as gravity sewers, so their condition may be expected to be better in general.

At this time, both repair and replacement are more widely used than rehabilitation in force mains. Repair can be undertaken within a short shutdown period, thus obviating the need for by-pass pumping. This is often a simple patching of a damaged or deteriorated area. On the other hand, replacement requires a major intervention. From the limited data available, it is estimated that replacement is the preferred approach for most utilities when faced with force main problems. Replacement comprises between 200,000 and 500,000 linear feet (60,976 and 152,439 meters) of force mains annually or some 0.1% to 0.15% of the total length. There are no equivalent data on the frequency of repairs for force mains.

The current market for force main rehabilitation is small compared to repair and replacement. No definitive data are available on the volume of force main rehabilitation since neither the utilities nor the vendors report this information. The best estimate is that between 50,000 and 100,000 linear feet (15,244 and 30,488 meters) of force mains in the US are rehabilitated annually. This represents some 0.02% to

0.03% of the overall length. There are a variety of reasons for this lower rate of rehabilitation in sewer force mains.

The first reason is the lack of consistently reliable and cost-effective sewer force main inspection methods. Taking a force main out of service for internal inspection is extremely disruptive and costly and external inspection can cover only a small part of the main. Thus, there is no viable sequence of risk assessment, inspection, condition assessment, and rehabilitation as there is in gravity sewer networks.

The second reason is that few rehabilitation technologies have been developed specifically for force mains. The technologies used in gravity sewers are generally not suitable for pressure applications, while those for water mains are focused more on water quality and corrosion protection than structural rehabilitation of the pipelines. Structural rehabilitation technologies for pressure pipes are in their infancy. Some crossover is needed between the sectors to address this issue. The result is that two management approaches are followed for force main asset management:

- (1) Await failure and replace.
- (2) Replace based on age and material rather than on actual condition.

Both strategies have their merits. Many force mains are small in diameter with almost half of force mains 12 inches (300 mm) in diameter or smaller. Inspecting these is difficult and costly and the cost of obtaining the information may exceed its value. Also, the consequence of failure for many of these mains may be low. Thus, awaiting failure and replacing with an emergency repair is a cost-effective strategy for many small diameter, non-critical force mains.

Replacement based on age and material, possibly alongside failure history, is also a viable strategy. With no direct condition assessment information available, condition cannot be a criterion.

However, neither strategy is adequate for critical force mains, where the consequence of failure is serious. This is recognized by the utilities and drives their need for inspection technologies and assessment methodologies that will provide information on likelihood of failure so that critical force mains can be managed actively and cost-effectively repaired, rehabilitated, or replaced to avoid failure. Future advances in force main inspection and an improved understanding of the host pipe condition may lead the way for the increased use of rehabilitation technologies in critical force mains.

3.2 Overview of Renewal Technologies

Force mains can operate with a wide range in pressures ranging from just a few feet of head to several hundred feet of head. Consequently, the list of potentially applicable renewal technologies is quite lengthy. The designer must consider the operating conditions that the renewal will be subjected to before selecting suitable candidates.

Some of the technologies presented in this report have not yet been used in a sewer force main to date, even though they have properties that make them suitable for these applications. System vendors are constantly making improvements and modifications to their products and services, so they should be consulted before using any of these listed products in a force main application to ensure compatibility.

A technology-specific datasheet was created for most of the technologies reviewed in this SOT report and are included in Appendix A. Table 3-1 summarizes the datasheets along with the diameter range and upper pressure limit for the various renewal methods. Vendor contact information can be found on each datasheet along with relevant case study information as available.

Table 3-1. Summary of Renewal Technologies with Applicability to Force Mains

Technology	Category	Brand Name	Vendor	Diameter Range, inches	Pressure Limit, psi	Appendix A pg no.
Internal Repair	Sleeve	Pressure-Seal	Link-Pipe	4-54	150	NA
Spray-On Lining	Polyurethane	Skotchkote	3M E. Woods	4-50	NA	A-1
	Polyurea	Skotchkote	3M E. Woods	4-50	NA	A-4
Close-Fit Lining	Symmetrical	Swagelining	Advantica	3-44	160	A-6
		Tite Liner	United Pipeline Systems	2-52	NA	A-8
		InsituGuard™ - Flexed	Insituform Blue	4-48	150	A-10
		Rolldown	Subterra	4-20	232	A-12
	Fold-and- Form PE	Subcoil	Subterra	4-12	NA	A-14
		Mainsaver	Mainsaver	NA	NA	A-16
		Subline	Subterra	3-60	NA	A-18
		InsituGuard - Folded	Insituform Blue	4-48	150	A-20
	Fold-and-Form PVC	Ultraliner PVC Alloy Pipeliner	Ultraliner	4-30	Low pressure	A-22
		EX Pipe	Miller Pipeline	6-15	Non-pressure	A-26
		AM-Liner II	American Pipe & Plastics	6-12	Non-pressure	A-28
	Expandable PVC	Duraliner	Underground Solutions	6-30	NA	A-30
CIPP	Polyester Felt	Inliner	Inliner Technologies (Reynolds Inliner)	4-120	60	A-32
		Pressure Pipe Liner (PPL)	Insituform Technologies	8-60	200	A-34
		National Liner	National Environ Tech Group	6-120	50+	A-37
	Glass Reinforcement	Paraliner FM	NOVOC Performance Resins	6-96	NA	A-39
		Reinforced Pressure Liner (RPL)	Insituform Technologies	8-72	NA	A-41
		Nordipipe	Norditube Technologies	5-48	60-250	A-44
		Berolina Liner	BKP Berolina Polyester GmbH (CIPP Corp)	6-40	45	A-46
		Blue-Tek	Reline America	6-48	NA	A-49
		Insitumain	Insituform Blue	6-36	150	A-51
	Carbon Fiber	Fibrwrap	Fibrwrap Corp.	≥36	150	A-53
		CarbonWrap	Carbon Wrap	≥36	150	A-56
		Pipe Medic	Quake Wrap, Inc	≥36		NA
Woven Hose	Adhesive	Starline HPL-S	Karl Weiss Technologies GmbH (Gas Technology Institute)	3-24	430	A-58
		Aqua-Pipe	Sanexen Environmental Services	6-12	150	A-60
	Non-adhesive	Saertex-Liner (Lightstream)	Saertex multicom GmbH	6-48	Non-pressure	A-62
		Primus Line	Raedlinger Primus Line GmbH	6-20	218-500+	A-64

Table 3-1. Summary of Renewal Technologies with Applicability to Force Mains (Continued)

Technology	Category	Brand Name	Vendor	Diameter Range, inches	Pressure Limit, psi	Appendix A pg no.
Glass Reinforced Thermoplastic	-	Aqualiner	Aqualiner	6-12	150	A-66
Sliplining HDD	PVC	Fusible PVC	Underground Solutions	4-12 (C900) 14-36 (C905)	305	A-68
	PE	HDPE and MDPE	Multiple producers	4-48		NA

3.3 Repair

Repair of a failure or a deteriorated section of a pipe is generally focused on only taking remedial action with one or two sections of pipe. Often times this work is done under emergency conditions. The first objective is to prevent any further spill or damage to the environment and the second objective is to restore service as quickly as possible. Figure 3-2 illustrates the various repair technologies applicable to sewer force mains.

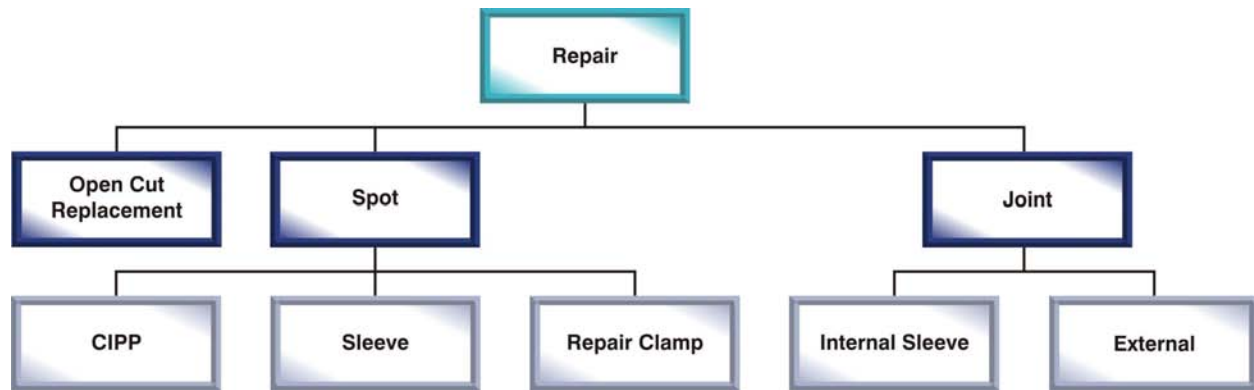

Figure 3-2. Repair Approaches for Force Mains

3.3.1 Open Cut Emergency Replacement. One of the most common methods of repair, especially for a burst type failure, is still to excavate and replace one or two sections of pipe. Depending on the type of pipe material, special adapters may be necessary to rejoin the new pipe sections to the existing pipe. This is true of PCCP where adapters and short sections are needed to replace a section. Other materials (such as CI, DI, or PVC) can be spliced in using either repair clamps or mechanical couplings with service restored very quickly.

3.3.2 Spot Repair – Trenchless. If not required under emergency conditions, there are other options to spot repair a section of pipe that is distressed.

3.3.2.1 Cured-in-Place Pipe. Short sections of a cured-in-place pipe (CIPP) liner, suitably designed for the operating pressure, can be installed over a short section of pipe that is distressed. However, to be effective, the CIPP liner needs to adhere to the original pipe such that water cannot migrate between the original pipe and the liner. Sealing the ends of the liner to the host pipe with an internal joint repair seal (e.g., Weko-Seal®) is one way to ensure a water tight seal.

Another new technology that is being used for the repair of pre-stressed concrete cylinder pipes that have experienced wire breaks is the use of a carbon fiber composite on the pipe interior surface. The internal surface has to be cleaned and then roughened, usually with water blasting. After roughening, the surface is dehumidified to ensure a good bond with the epoxy resin. There are two approaches to the application of the carbon fiber textile. Pipe Medic is a patented composite material available from Quake Wrap where the carbon fiber is already embedded in a pre-cured epoxy resin. It resembles wall paper. A layer of epoxy adhesive is applied to the PCCP internal surface and then the Pipe Medic sheet is uncurled and rolled into the epoxy. The more traditional method of use has been to wet out the carbon fiber with epoxy resin just before application and then apply the uncured epoxy and carbon fiber composite to the interior surface. NSF 61 certified epoxy top coats are applied over the composite for potable water applications.

3.3.2.2 Sleeve. Link-Pipe, a Canadian manufacturer of trenchless pipe repair products, has a product available for use in a pressurized system (Figure 3-3). Pressure-Seal™ Sleeves are available in diameters from 4 to 54 inches (100 to 1,350 mm), and standard lengths of 12, 18, 24 and 36 inches (300, 450, 600, and 900 mm). Pressure-Seal™ is designed for sealing pressure pipes up to 150 pound per square inch (psi) (10.3 bar) and it is uniquely suitable for old CI mains that have unpredictable variations in manufacturing tolerances, roundness, and joint offsets to which the sleeve will conform. Each sleeve is specifically manufactured for each location so it is important to get an accurate measurement of the inside diameter of the pipe. Some problems have been reported when the diameter was not closely measured.



Figure 3-3. Link-Pipe 12 inch Pressure-Seal

The sleeve core is made of stainless steel SST-316 with internal locking mechanism. An outside gasket is saturated with sealant that is mechanically pressed against the host pipe when the sleeve is expanded and locked in place. The sealant is ambient temperature cured and seals the sleeve in place, creating a mechanical bond by filling surface roughness as well as chemical adhesion, thus sealing the joints and pin holes. Link-Pipe has other trenchless repair technologies (e.g., Link-Pipe PVC™), but these are not for internal pressurized systems, rather they are designed to resist external soil loads.

3.3.2.3 External Repair Clamps. The second most common method of repairing a break in a sewer force main, aside from open cut replacement, is to place a full circumferential repair clamp over the damaged section (Figure 3-4). The clamp must be wide enough to seal on adjacent pipe wall that is structurally sound. If the wall is not sound, then replacement is the only viable solution. There are a wide variety of repair clamps, some coming in multiple pieces so they can be placed around a damaged section of pipe without removal of the pipe.



Figure 3-4. Romac SS2 Repair Clamp

3.3.3 Joint Repair

3.3.3.1 Internal Joint Repair. The basic principal of most internal joint repair systems is a rubber sleeve that bridges over the leaking joint, which is then compressed and sealed against the adjacent pipe wall by expanding two stainless steel compression rings. For wastewater or water applications, the sleeve is made of ethylene propylene diene M-class (EPDM) rubber.

These sleeves can also be used to seal a radial crack in a pipe wall or transition between two different pipe materials. The AMEX 10[®] seal incorporates a medium density polyethylene (MDPE) backing band behind the rubber seal to accommodate external hydrostatic pressure (Figure 3-5). The AMEX 10 Vario can also be used to seal a longitudinal crack with its ability to span an extended longitudinal length by stacking the sleeves. The sleeves have enough flexibility to allow some additional joint rotation without leakage after installation. Naturally, for a good leak tight seal, the inner surface must be free of any corrosion by-product and smooth. They have also been used to seal a steel slipliner, grouted inside a PCCP pipe, to the PCCP pipe wall. Specially designed transition sleeves are required to accommodate the large difference in internal diameter associated with this application.

As shown in Table 3-2, there are three primary manufacturers of internal joint repair sleeves.



Figure 3-5. AMEX 10 Mono Seal

Table 3-2. Summary of Internal Joint Vendors

Supplier	Product Name	Diameter Range	Max. Internal Pressure
Miller Pipeline Corp.	Weko-Seal [®]	16 to 216 inches	300 psi
AMEX, GmbH (Germany)	AMEX 10 [®] Mono and Vario	20 to 236 inches	290 psi
NPC, Inc.	NPC Internal Joint Seal	18 to 122 inches	30 psi

3.3.3.2 External Joint Repair. Most of the external joint seals on the market are designed to seal a gravity pipe joint, with minimal internal pressure. There have been mechanical devices designed in the past that will seal a leaking PVC bell joint with a displaced gasket, or one for a lead caulked CI joint, which encapsulates the joint in a bitumastic material. However, the market for these specialty products is very limited. The most common repair technique is to remove the offending joint rather than trying to patch a repair.

3.4 Rehabilitation

In this report, rehabilitation will focus on the renewal aspects of sewer force mains where the existing pipe becomes part of the renewal work. If the rehabilitation is to provide only corrosion protection, or the existing pipe is only partially deteriorated, then the remaining structural strength of the existing pipe is incorporated into the fabric of the completed system. For fully deteriorated situations, the existing pipe acts merely as a right-of-way for the installation of the structural liner.

As shown in Figure 3-6, rehabilitation methods will include the use of spray-on linings, close-fit linings, CIPP, and woven hose lining systems. Technologies for each of these rehabilitation categories are discussed in this report in addition to cleaning requirements prior to rehabilitation. Because only limited rehabilitation work has been undertaken to date on sewer force mains, many of the systems available were originally developed for water main rehabilitation, but can be adapted to sewer force mains. Sewer force mains have some characteristics in common with water mains. Both tend to be relatively shallow buried and both operate under internal pressure. However, they also have some significant differences. An NSF 61 certification is not required for a force main as it does not carry potable water for human consumption. Force mains also do not have service connections, which must be reinstated to restore service to stakeholders. Force mains transport raw sewage, which can release hydrogen sulfide (H₂S) gas at high points or near discharges, leading to microbiological corrosion of the pipe material. Also, it is usually very difficult to take a force main out of service for an extended period of time (unless redundancy exists), which will necessitate by-pass pumping during any cleaning or rehabilitation effort.

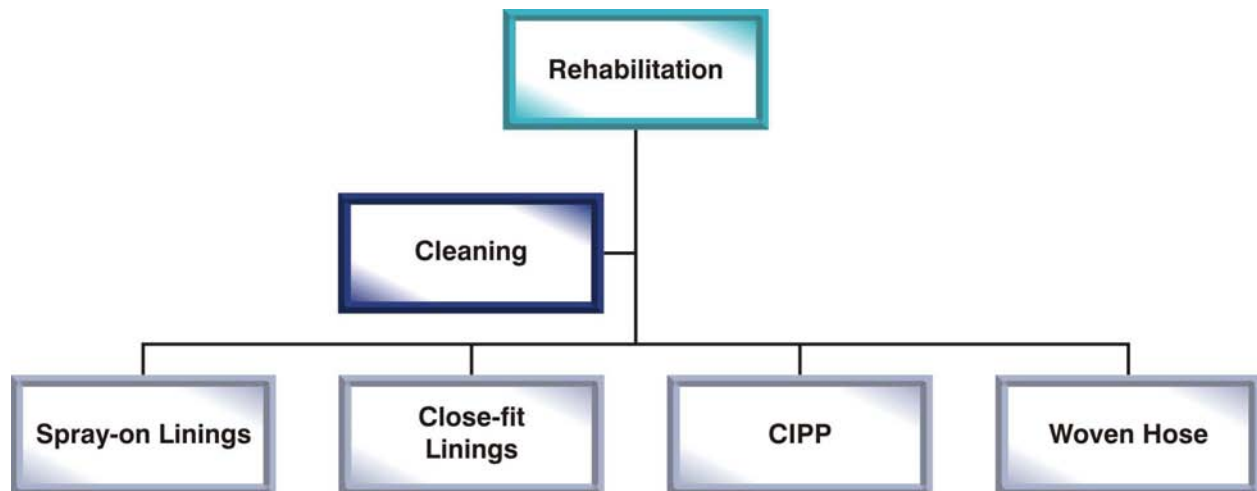

Figure 3-6. Rehabilitation Approaches for Force Mains

3.4.1 Cleaning Requirements. All of the rehabilitation methods require some cleaning of the interior surface of the original pipe. The extent of cleaning will depend on the chosen method of renewal. Spray-on linings will require the most extensive cleaning as the lining material must adhere to the surface, followed by close-fit and CIPP liner products. Sliplining is considered a replacement method, but it requires the least intensive cleaning as contact with the host pipe is not achieved.

Cleaning methods for force mains would include power boring, which is recommended for spray-on polymer liners, foam pigs, mechanical scrapers, and water jet cleaning. Chemical cleaning with hydrochloric (HCl) acid is intended mainly for the removal of tuberculation (ferric oxide) and is therefore

more appropriate to a water main where the cleaning solution can be easily re-circulated. More information on cleaning methods and technologies is covered in Section 6.

3.4.2 Spray-on Linings. Spray-on linings have been one of the easiest methods of rehabilitating a pressurized main when the primary objective is just to provide corrosion protection to the interior surface. Spray-on linings are either cementitious or polymer based as shown in Figure 3-7.

With a large population of unlined CI water pipe in the US, it is not surprising that one of the more common methods of rehabilitation has been to apply a cement mortar lining in water distribution networks. In the UK, where water supplies tend to be more “soft” than in the US, cement mortar linings were first supplanted by spray epoxy liners and then by polyurethane (PU) linings which today dominate 80% of the UK spray-on liner market. The main advantage of PU over epoxy is the fast 30-minute cure time. The equipment and application are essentially the same.

3.4.2.1 Cement Mortar Linings. Cement mortar lining is not suitable for the conveyance of aggressive (soft) water, nor would it be recommended for the rehabilitation of a sewer force main. It involves centrifugally casting cement mortar against the wall of the pipe with sufficient velocity to densely pack and adhere the mortar. The interior mortar lining is then mechanically trowelled to provide a smooth surface. Cement mortar lining is most commonly used for corrosion protection in ferrous water pipes, but is not suitable for sewer force mains.

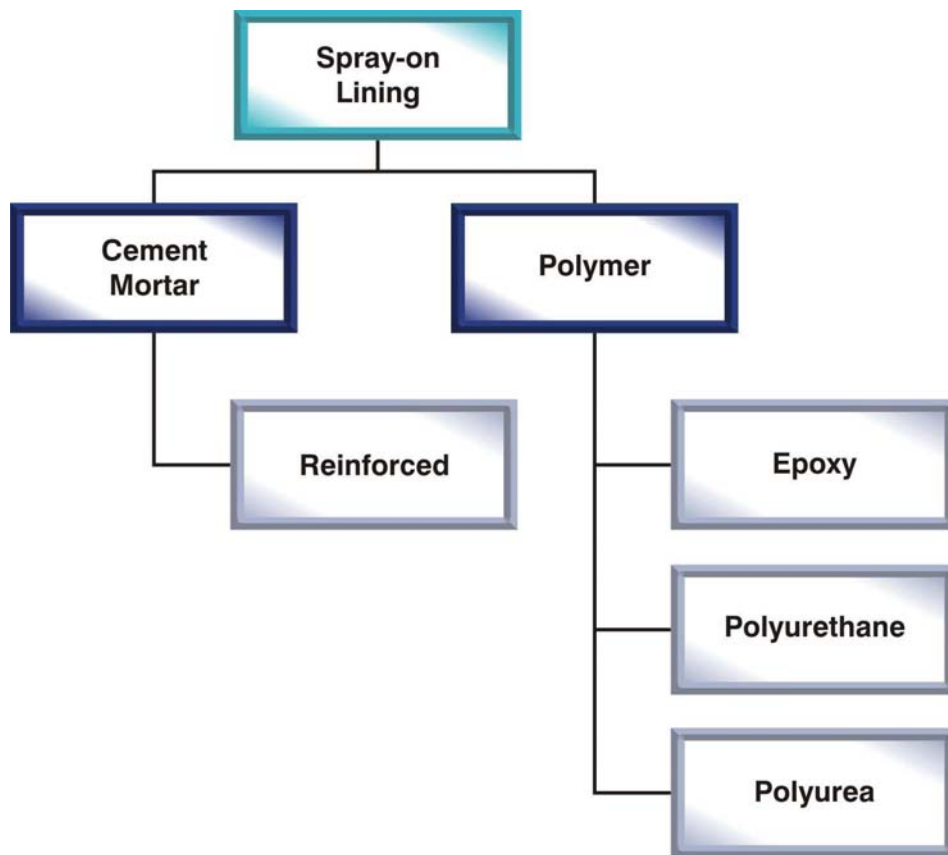

Figure 3-7. Summary of Spray-on Lining Technologies

3.4.2.2 Reinforced Mortar Linings. A modification of cement mortar lining is to incorporate some steel reinforcement in the mix to accommodate structural needs. One such modification, ferrocement, uses fine wire mesh to reinforce the mortar mix, enhancing its tensile strength and crack resistance. Figure 3-8 illustrates the typical stress-strain performance of a ferrocement composite. The crack resistance of the composite is dependent on the relative volume of mesh reinforcement to mix.

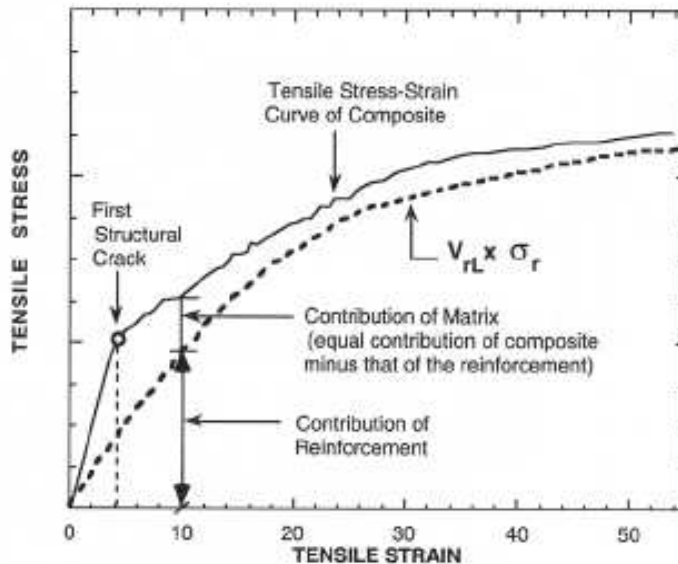

Figure 3-8. Typical Stress Strain Curve for Ferrocement (Newman, 2000)

This concept was used for the design of a 50-inch (1,250-mm) diameter asbestos cement sewer force main in Tel Aviv, Israel (Thomson et al., 2006). The 50-inch (1,250-mm) force main experienced a catastrophic failure. Investigation found that a groove had been eroded down the invert of the main. Stress concentrations caused by the groove placed the main in danger of future failure. The main operated under high pressure (150 psi [10.3 bar]) and could not be sliplined. The only feasible method of rehabilitation was to build a fully structural liner inside the existing main. A thin hybrid liner, less than 2.36 inches (60 mm) thick, was designed incorporating reinforced concrete covered by a two-mesh ferrocement layer. Polymer fibers were also incorporated into the mortar mix to enhance crack resistance. An epoxy liner was specified for further corrosion protection, but was not deemed necessary.

3.4.2.3 Epoxy Spray-on Linings. Potable water in the UK comes predominantly from surface water, could be characterized as soft water, and is aggressive to cement mortar linings. Consequently, back in the 1970s and 1980s, water main lining contractors in the UK began to research for alternative materials. The WRc (formerly known as the Water Research Center), in conjunction with one epoxy vendor (E. Wood Ltd.), developed an epoxy material and delivery system that could meet the strict UK water quality standards. Within a very short time period, epoxy lining completely replaced cement mortar lining. With a much shorter cure period of 16 hours, water mains can be returned to service within 36 hours. The following epoxy coating systems are approved by the Drinking Water Inspectorate (DWI) in the UK:

- 3M E. Wood Ltd – Scotchkote 162 PWX and Geopox GX 014
- Leighs Paints – Pipegard P300
- Subterra – ELC 173/90

The first field trial of epoxy lining in the US, co-sponsored by the American Water Works Research Foundation (AWWARF, now known as Water Research Foundation), WRc, and the epoxy contractor, was in 1993 in Chester, PA. Epoxy lining usage has not taken off in the US as it did in the UK. There

are, however, several communities (e.g., Charlotte-Mecklenberg) that have used epoxy lining extensively. One of the limitations to epoxy lining for water mains has been the need to get NSF 61 certification. This involves not only having the material certified, but also the delivery system as any unmixed or uncured resin or hardener can pose a chemical hazard. There are over 41 companies which have their epoxy products certified to NSF 61 as suitable for lining either water tanks and/or water mains (with diameter restrictions). Not all of the listed resins are actively promoted for lining water mains. Some of the more commonly used resins are similar to those used in the UK. A few examples of these products are listed below:

- 3M Scotchkote 162 PWX
- Fyfe Company Tyfo™ PWC
- Hunting Industrial Coatings – Waterline
- Mercor Products – GeoPox GX 104
- NeoPoxy NPR-2000
- Nitoline
- NSP Specialty Products – NSP 120
- Raven Lining Systems – AquataPoxy A-6 and A-61
- Subterra - ELC

In 2007, the American Water Works Association (AWWA) standard AWWA C620 *Spray-Applied In-Place Epoxy Lining of Water Pipelines, 3-inch (75-mm) and Larger* was published providing the first national standard for epoxy lining. Up to this point, only a WRc guidance note was available. The epoxy is a two-component material containing 100% solids by volume and must be capable of adhering to dry and moist surfaces.

Prior to spin application of the epoxy, the host pipe's interior surface must be free of corrosion by-products, deposits, loose and deteriorated coatings, oil, grease and accumulations of water, dirt and debris. Power boring, drag cleaning, or abrasive pigging followed by foam swabbing is the preferred method of preparing the inner surface.

For water main applications, one coat of epoxy with a minimum dry film thickness of 40 mils (1 mm) is recommended. A dry film thickness of 80 mils (2 mm) is achievable and would be preferred for any sewer force main applications given the higher corrosion potential offered by the effluent.

3.4.2.4 Polyurethane Spray-on Linings

Standard Polyurethane

Polyurethanes, which are a two-part poly-isocyanate, have virtually replaced the use of epoxy liners in the UK. Polyurethane liners represent 80% of the UK market. They are applied using the exact same spin equipment as epoxies. The thickness of the minimum dry film recommended is 40 mils (1 mm), the same as epoxy, but the cure time is only 30 minutes. Consequently, the outage time for carrying out a polyurethane lining operation can be less than 6 hours which, in a water distribution project, may negate the need for any alternative water supply, thus saving money. The following polyurethane coatings are approved by the DWI in the UK:

- 3M E. Wood Ltd – Scotchkote 169, Scotchkote 169HB, and Scotchkote 169LV
- Subterra – Fast-Line and Fast-Line Plus

Hi-Build Polyurethane

3M (E. Wood)

One of the pioneers in the development of epoxy and polyurethane liners was E. Wood Ltd., a UK company. They were acquired by 3M in 2008. E. Wood has developed a hi-build polyurethane liner, which can be considered a semi-structural liner (i.e., one capable of bridging over holes in the host pipe). This product was called Copon Hycote 169HB, but has been renamed Skotchkote for distribution in the US. The product has DWI approval in the UK for use in a potable water system.

Copon Hycote underwent trials at Yorkshire Water and South West Water in 2004 and 2005, respectively and was commercialized in 2005. Well over 200 km of water pipe have been lined to date. The smallest diameter has been 4 inches (100 mm) and the largest 20 inches (500 mm). Bristol Water, a UK water company with a poor burst history and water quality, is lining pipe with a 1.5 mm thickness where water quality is dubious and 3 mm in areas prone to breaks. Since undertaking this program, Bristol Water has not experienced a single break.

Tests have been carried out at Bradford University on 4 inches (100 mm) diameter pipes with 0.4 inches (10 mm) and 1 inch (25 mm) gaps. The liner failed in the pipe with the 0.4 inches (10 mm) gap at 1,015 psi (70 bar) and 391 psi (27 bar) in the pipe with the 1 inch (25 mm) gap. The thickness of the liner applied was not reported.

It is envisioned that this new emerging material could also be utilized in a sewer force main, providing the inner surface can be sufficiently cleaned to allow proper adhesion. So far, this has not been demonstrated.

3.4.2.5 Polyurea Spray-On Linings

Standard Polyurea

A new family of polymer spray-on linings, based on the use of polyurea, is finding rapid acceptance for lining manholes, wetwells, and other structures exposed to corrosive environments. One of the principal benefits of the use of polyurea is a very fast cure, with gel times in 5 to 40 seconds and 80% cure in just 5 minutes. Structures can be put back into service 30 minutes after the application of the polyurea. Full cure is achieved in 24 hours. The other primary benefit is the ability to spray apply a thickness from 0.25 to 2 inches (6 to 50 mm). The thick liner means this spray-on lining system also has the ability to be used as a semi-structural or even a structural liner.

Innovative Painting and Waterproofing, Inc.

Innovative Painting and Waterproofing has developed a robotic delivery system that allows the spray application of polyurea to pipes as small as 6 inches (150 mm) in diameter. These materials are not yet NSF 61 listed, but could be used in a sewer force mains where that requirement does not pertain. The bond strength to concrete on flat work is reported to be 350 to 800 psi (24 to 55 bar) and on sand blasted white metal over 2,000 psi (138 bar).

PolySpray

Hunting Specialized Products produces three lines of polyurea spray-on linings, which range from flexible to stiff, based on the flexural modulus of elasticity. Table 3-3 identifies the physical properties for Hunting's polyurea. The Flexible HE800 is tantamount to rubber with 800% elongation. For design purposes (e.g., ASTM F1216), Hunting reports that the long-term (50 year) flexural creep modulus would be 50% of the values listed in Table 3-3. In the case of the Fully Structural FS250 material, the flexural modulus is comparable to some CIPP products.

Table 3-3. Properties of Hunting Polyurea Spray-on Linings

Type	Tensile (ASTM D638)			Flexural (ASTM D790)		
	Strength psi	Modulus psi	Elongation %	Strength psi	Modulus psi	Shrinkage %
Flexible HE800	1,700	1,200	800	1,400	22,500	0
Semi-Structural SS100	3,400	41,200	100	4,300	93,000	0.5
Fully Structural FS250	12,000	160,000	20	9,300	250,000	1

3M

3M Water Infrastructure has announced a new product, Scotchkote™ Spray In Place Pipe (SIPP) 269 Coating, which is a patent pending-polyurea blend. The Scotchkote™ SIPP 269 Coating just received certification against NSF 61 for use in potable water applications. The reference to a coating is misleading as the material is actually intended to be used as a liner. Little technical data were available at the time of this report. It is understood that the Trenchless Technology Center (TTC) will be conducting some long-term performance tests on this polyurea material.

Nano-Enhanced Polyurea

The TTC at Louisiana Tech University is working with one vendor of polyurea resins to develop a nano-enhanced version of polyurea, which would have even higher flexural modulus, well above the 250,000 to 375,000 psi (17,241 to 25,862 bar) achievable with today’s standard technology. The trade off with the higher modulus is a lower elongation, but 5% elongation should be adequate for most pipe rehabilitation projects.

3.4.3 Close-Fit Lining Systems. The use of close-fit liners is often called modified sliplining. It involves the use of a thin walled PE liner with an outside diameter that is similar to the inside diameter of the host pipe. The key to installing the liner is to temporarily reduce the liner diameter to facilitate its insertion into the host pipe. Once the liner is in place, it is reverted back to its original outside diameter forming a close-fit to the host pipe. The reinstatement of connections and fittings often requires special techniques and fittings.

As shown in Figure 3-9, close-fit liners can be classified into two broad categories including those that achieve temporary diameter reduction through: (1) a symmetrical reduction process; and (2) a fold-and-form process. In the case of the symmetrical diameter reduction process, these can rely upon either axial tension or radial compression to reduce the diameter. Fold-and-form liners, depending on diameter, can be pre-folded and coiled into spools at the factory or deformed on site.

Close-fit liners are usually thin walled (standard dimension ratio [SDR] > 33) so they maximize the retention of flow cross-section. There are a range of products from which to choose including thin semi-structural liners to thicker fully structural liners. On the other hand, most liners are “non-standard” PE diameters and require special fittings. Many of the early technologies came from the UK and were subject to licensing and other commercial arrangements with international companies.

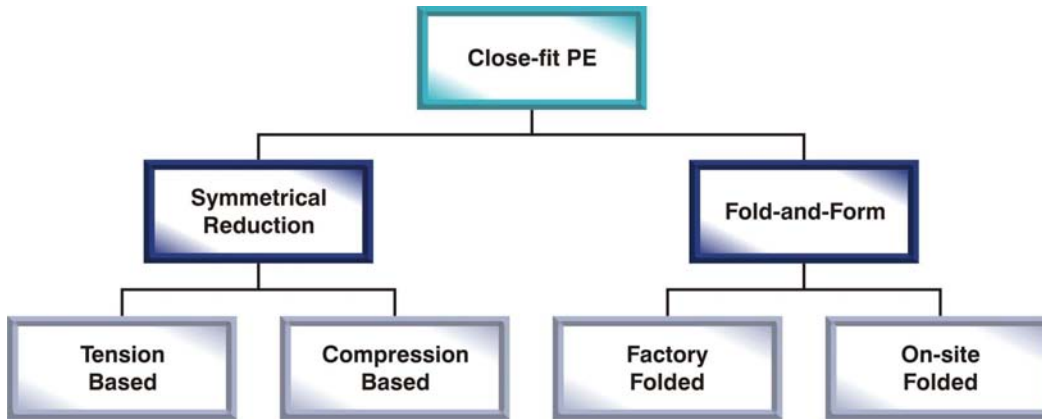

Figure 3-9. Summary of Close-Fit PE Technologies

The installation of a close-fit liner is similar to sliplining in that the liner is pulled or pushed into the existing pipe except with close-fit liners additional stages are needed for the diameter reduction prior to insertion and then reversion after insertion. Also, the host pipe needs to be more extensively cleaned than for ordinary sliplining given the close-fit of the liner. Some additional potential issues can occur during installation of these relatively thin liners as follows:

- Accuracy in the alignment of pipes for butt fusion welding is more critical
- Tensile forces during pull in of the liner need to be monitored and controlled
- Limiting surface damage to no more than 10% of thickness during installation is more difficult to achieve with a thin liner.

Despite some of these concerns, the use of a close-fit liner can be one of the more cost-effective ways to rehabilitate a partially deteriorated sewer force main. As Figure 3-10 illustrates, a PE liner is capable of bridging significant gaps in the host pipe. As an example, a 36-inch (900-mm) diameter SDR 50 PE liner ($t = 0.71$ inch) in a system with an operating pressure of 150 psi (10.3 bar), can span a hole of 9 inches (225 mm) in diameter in the host pipe.

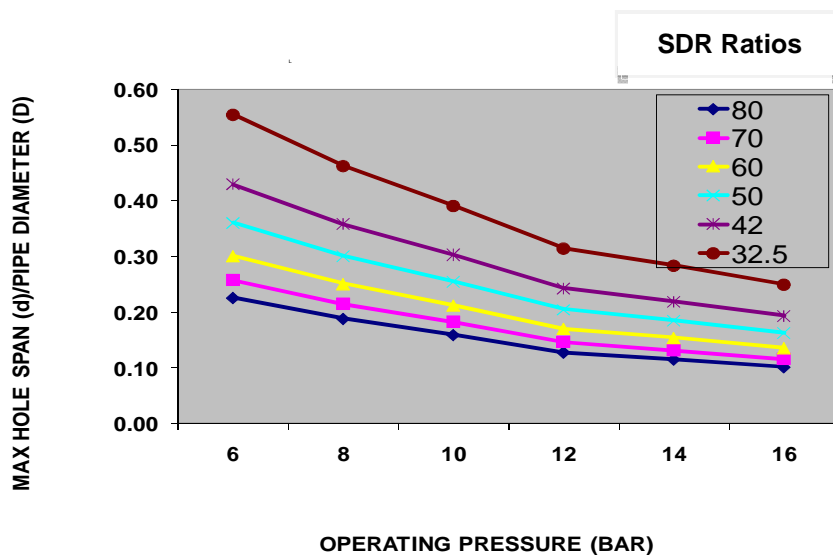

Figure 3-10. PE Close-Fit Liner Hole Spanning Capabilities

3.4.3.1 Symmetrical Reduction Close-Fit Lining – PE

Tension Based (Static Die, Roller Die) Symmetrical Reduction

In the tension-based, symmetrical-reduction process, the diameter of the PE pipe is temporarily reduced, while maintaining a circular cross section, by pulling the pipe through a static die or simultaneously pushing it through a series of concentric rollers. The advantages of a tension based close-fit PE liner are its quick installation and relatively low cost. However, winch loads can be very high, and, with insertion clearances relatively small, the process is susceptible to jamming at obstacles (e.g., an offset joint). Local obstacles can lead to incomplete reversion and high residual tensile stresses that can create problems for fittings. Also, the liner pipe must be pulled into the existing pipe all at one time without stoppage or release of tension. If the pipe reverts during installation, there is no way to move it.

Swagelining

Swagelining was originally developed by British Gas for rehabilitating gas mains and is now offered by Advantica. It is one of the original symmetrical-reduction PE pipes using the static die method. The starting PE pipe, made of PE 3408 (80), initially has a larger outside diameter than the inside diameter of the pipe to be lined. After sections of the PE pipe are butt fused together to form a continuous pipe, the PE pipe is pulled through a reduction die to temporarily reduce its diameter. This reduction is maintained by the tension exerted from the pulling cable. After the pipe has been pulled through the existing pipe, the pulling force is removed and the PE pipe returns to its original diameter. Swagelining has been used for diameters from 3 to 44 inches (75 to 1,100 mm) and in diameter ratios (DRs) from 11 to 42. With the lower DR products, the resulting close-fit PE liner can be considered a fully structural liner for pressure applications. The pressure class of PE pipe, based on the current AWWA standard C906-07, is given in Table 3-4. As most sewer force mains tend to operate at pressures well under 80 psi (5.5 bar), a DR 21 PE pipe is probably the thickest that would ever be considered for a rehabilitation project. The pressure rating of PE pipe is sensitive to the maximum operating temperature that the system will experience. For operating temperatures between 81 to 90°F, the pressure class is derated 10%, and for 91 to 100°F a 20% derating is applied. The pipe manufacturer should be consulted for adjustments above 100°F.

Table 3-4. Pressure Class of PE 3408 based on AWWA C906 at 80°F

Dimension Ratio	Pressure Class	
	psi	kPa
32.5	51	352
26	64	441
21	80	551
17	100	689
13.5	128	883
11	160	1,103

Note: Based on AWWA C906 at 80°F

Tite Liner®

Tite Liner was introduced into the US in 1985 and, since then over 8,000 miles of the PE liner has been installed. Tite Liner is marketed by United Pipeline Systems, a division of Insituform Technologies. Tite Liner is a symmetrically reduced PE liner where the continuous pipe made up of previously butt fused sections is pulled through a roller reduction unit which radially compresses the liner outer diameter. Once the liner is in place, the tension is released and the Tite Liner expands radially to fit the inside of the existing pipe. Tite Liner has primarily been used in the oil and gas industry to provide internal corrosion protection and abrasion resistance to steel pipes. In the case of the water and wastewater industry, Tite Liner has been used as a semi-structural (Class III) liner given its relatively thin wall thickness. Tite

Liner is custom made with an outside diameter smaller than the host pipe's inside diameter and is available in either PE3408 (80) or PE4710 (100) resins with diameters from 2 to 52 inches (50 to 1,320 mm). An insertion length of up to 2,600 feet (800 meters) has been achieved.

PolyFlex™

Another example of a roller die tension based system, which also incorporates some of the features of a compression based system is the new PolyFlex product offered by Insituform Blue. PolyFlex's introduction in 2008 was primarily targeted at the potable water industry, as PolyFlex is an NSF 61 certified material. However, PolyFlex has also been considered for use on sewer force mains (Regina, SK in Canada). After butt fusing the sections of PE pipe into a continuous line, the pipe is both pushed and pulled through the roller reduction unit. The outside diameter of the pipe is reduced up to 20% by the roller reduction unit (Figure 3-11). The pipe can be pulled through lines with up to 22.5 degree bends. After the line is in place the tension is released and the pipe radially expands back to its original diameter. PolyFlex is available in diameters from 4 to 63 inches (100 to 1,600 mm). PolyFlex is made from PE4710 (100) resin, which has improved toughness and better crack propagation properties than PE3408 (80). Consequently, the hydrostatic design basis (HDB) is higher too. Unfortunately, the higher HDB is not yet recognized in the current AWWA C906 standard so, in the strictest sense, this improvement cannot be fully capitalized on yet. PolyFlex can be either a semi or fully structural liner with pressure rating up to 150 psi (10.3 bar) in the smaller diameters.



Figure 3-11. Roller Reduction Unit for PolyFlex

Compression Based (Roller Die) Symmetrical Reduction

In a compression based system, the PE pipe is pushed through a die consisting of a series of concentric concave rollers (see Figure 3-12). The diameter reduction is associated with a thickening of the pipe wall rather than an increase in length. The majority of the diameter reduction is retained after passage through the reduction equipment. After insertion of the liner, it is reverted to its original diameter using water pressure. The advantages of the compression system is lower winch loads, possible separation of the reduction and insertion stages, more tolerance of obstructions in the host pipe, ability to stop and start the insertion process, and minimum residual tension in the installed liner. The equipment for compression reduction can have a high capital cost, especially given its diameter specific nature.

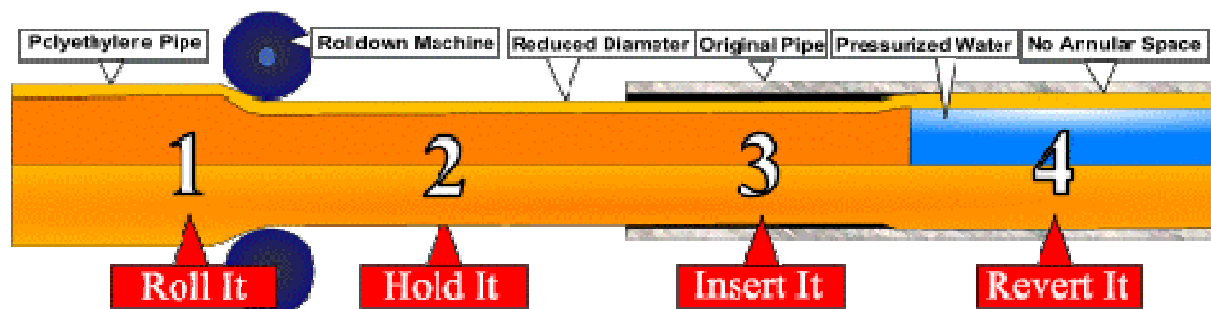

Figure 3-12. Illustration of PE Pipe Compression

Rolldown

Rolldown was developed in the late 1980s by Subterra (a division of Daniels Contractors Ltd., UK) as a complement to Swagelining and was used in the British Gas renovation program. Rolldown uses standard grade PE (PE3408) and is available in diameters from 4 to 20 inches (100 to 500 mm). Depending on diameter and starting DR of the stock liner, pressure ratings up to 232 psi (16 bar) are achievable. Rolldown has been installed up to 5,000 feet (1,524 meters) in one insertion. The PE pipe holds its reduced diameter indefinitely prior to reversion, which allows for interruptions during the insertion process which is not possible with a tension-based system. The string of PE pipes can be pulled through a bend of up to 11.25 degrees. After insertion, the line is reverted to its original diameter by water pressure. Standard couplings are attached to the ends of the PE pipe and used to reconnect to fittings or the existing main.

3.4.3.2 Fold-and-Form Close-Fit Lining – PE. Another method of achieving a close-fit PE liner is to fold the PE pipe into a “C” or heart shape to facilitate insertion of the liner into the host pipe, and then to revert the liner back to its original round shape by the use of heat and/or pressure to form a close-fit. The folding process can be carried out in the factory or on site, depending on the diameter of the PE liner. A further distinction can be made, as illustrated in Figure 3-13, for factory-folded liners, as to whether the reversion uses heat to help re-round the PE pipe. Both factory-folded and on-site folded technologies, as shown in Figure 3-13, are discussed below.

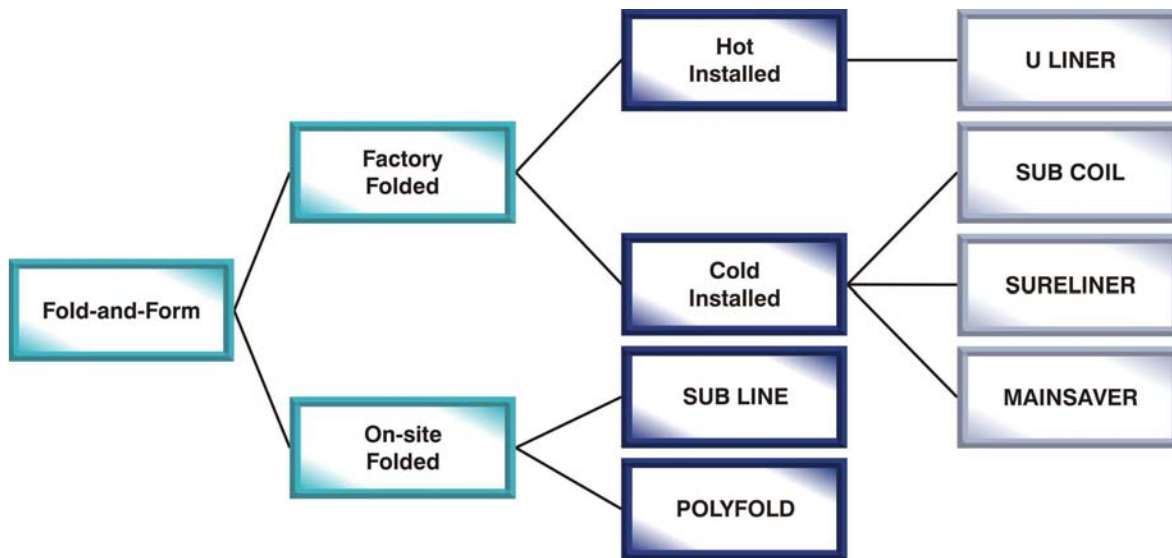

Figure 3-13. Summary of Fold-and-Form Close-Fit Lining Technologies

Factory-Folded PE Close-Fit Lining

Uliner and Sureliner (shown in Figure 3-13) are no longer commercially available.

Subcoil

Subcoil is another close-fit PE liner jointly developed by Subterra and United Utilities. Subcoil is a close-fit PE pipe that is factory folded and held in a “C” shape. The pipe is shipped to the jobsite on large spools. After insertion, the liner is pressurized with water at ambient temperature breaking the temporary bands holding the pipe in a “C” shape and reverting the pipe back to its original dimensions. Proprietary couplings are then attached to the end of the exposed pipe sections and make-up pieces inserted to reconnect to the existing main. Insertions of up to 3,500 feet (1,067 meters) have been achieved. Subcoil

is produced by Wavin and Glynwed Pipe Systems in diameters from 4 to 12 inches (100 to 300 mm) and is made from PE3408 resin. The liner is only intended to be a semi-structural liner (Class II). At the present time, Subcoil is not distributed in the US.

Mainsaver

Originally called Cemfil, Mainsaver was first introduced in the UK in 1999 and later in the US in 2006. Marketed by Mainsaver out of Golden, CO, approximately 5,000 feet (1,524 meters) of the product has been installed in several municipal water systems in the Rocky Mountain region. Annual installations of Mainsaver are expected to grow to 20,000 feet (6,098 meters) per year. Mainsaver is a flexible MDPE tube with integral grout key hooks on the outside surface. Before insertion of the tube, any open service connections are robotically plugged so that grout cannot migrate. After the tube is inserted into the main, a proprietary grout is placed between the tube and the host pipe, and a rounding swab is driven through the tube by air pressure. The swab progressively expands the tube and distributes the grout against the interior surface of the host pipe. Air pressure is maintained for 16 hours to allow time for the grout to hydrate. After hydration, the liner is inspected with closed circuit television (CCTV) and infrared thermography (as a QC check against grout voids). Mainsaver’s RoboTap is used to remotely reinstate any plugged service connections and special end seals are installed to protect the ends of the new liner. The liner can be laid through 22.5° long radius elbows and renewal lengths of up to 500 feet (152 meters) are possible. The cementitious grout provides corrosion protection to the underlying ferrous mains, while the PE liner ensures water quality. Mainsaver is not a fully structural liner, but rather a semi-structural liner that relies upon adhesion to the host pipe for strength (Class III). It can be used with ferrous or cementitious pipes. Mainsaver is available in diameters 4 to 12 inches (100 to 300 mm). The total thickness of the PE and grout is approximately 3/16 inches (3 mm). It can bridge a maximum hole size of 2.4 or a gap of 0.4 inches (10 mm) with pressures up to 294 psi (30 bar). The cost for installing Mainsaver was said to be comparable to cement mortar lining, but no cost data were provided.

On-Site Folded PE Close-Fit Lining

The close-fit PE liners that are available in larger diameters tend to be on-site folded products. The relationship between the diameter of pipe and the maximum thickness (lowest SDR) that can be folded is given in Figure 3-14. Note that the higher strength PE4710 (PE100) is less capable of being folded than the standard grade.

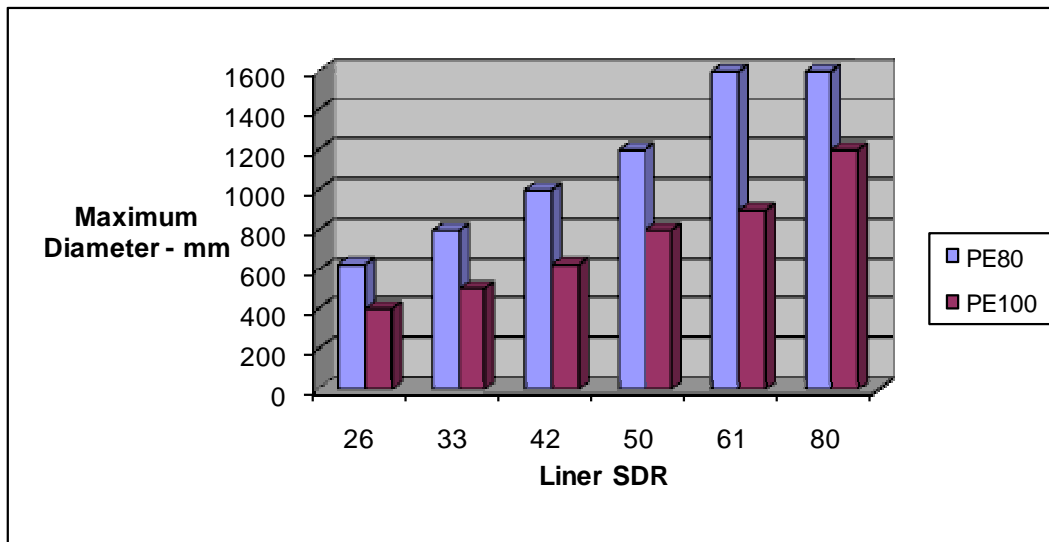

Figure 3-14. Relationship Between Diameter and SDR for Folding

Subline

Subline, offered by Subterra, is a close-fit and fold-and-form liner made of standard grade PE (PE3408). After butt-fusion welding, the continuous liner is pushed through a former that folds the liner into a “C” shape and temporarily maintained by restraining bands (see Figure 3-15). After insertion, the liner is pressurized with water at ambient temperature breaking the bands and reverting the pipe back to its original dimensions. The liner can negotiate up to 45° bends during insertion. Proprietary couplings are then attached to the end of the exposed pipe sections and make-up pieces are inserted to reconnect to the existing main. Installations of up to 3,500 feet (1,067 meters) are achievable. Subline is designed to be a thin-wall PE liner that bridges over holes and gaps in the host pipe (semi-structural – Class II) and comes in diameters from 3 to 60 inches (75 to 1,600 mm). Thicknesses range from 0.12 to 0.80 inches (3 to 20 mm).



Figure 3-15. Subline Forming into “C” Shape

PolyFold™

In 2008, Insituform Blue introduced two close-fit PE liner products, one being a fold-and-form product called PolyFold (Figure 3-16). Like PolyFlex, PolyFold is made with the improved toughness and crack resistant PE4710 (PE100) resin. PolyFold is available in diameters from 4 to 63 inches (100 to 1,575 mm) and pressure ratings up to 150 psi (10.3 bar). With NSF 61 certification, PolyFold also is suitable for potable water applications. PolyFold is site folded into a “C” by pushing the continuous PE pipe through a folding machine and then banding the folded shape. A diameter reduction of up to 40% can be achieved, which greatly facilitates the insertion of PolyFold into an existing pipe. PolyFold can easily navigate bends up to 22.5°. Once the liner is in place, it is cut to length, end fittings are attached, and the liner is pressurized to snap the bands. Depending on the pressure and diameter, PolyFold can either be a semi-structural or fully structural liner for a sewer force main.



Figure 3-16. PolyFold™ Banding

3.4.3.3 Fold-and-Form Close-Fit Lining – PVC (Alloy)

Factory-Folded PVC Close-Fit Lining

All of the fold-and-form liners based on PVC resin formulations are factory-folded as heat is required to deform the liner.

Ultraliner PVC Alloy Pipeliner™

PVC Alloy Pipeline was first introduced in 1994 by Ultraliner and since then the company has installed over 4.5 million feet (1.37 million meters) of liner. The usage of Ultraliner appears to be equally dispersed across its diameter range of 4 to 30 inches (100 to 750 mm). PVC Alloy Pipeliner™ has been used in 36 states and is approved by 30 State Departments of Transportation (DOTs) for use on drainage culverts, which is one of Ultraliner’s largest markets.

Ultraliner PVC Alloy Pipeline is a solid wall PVC pipe manufactured from virgin PVC homopolymer resin with no fillers, which is later modified with special additives to improve ductility and toughness. The Pipeliner™ is collapsed flat and coiled on a reel in continuous, jointless lengths. Small diameters (12

inches [300 mm] and less) are folded in the field prior to insertion, while larger diameters (15 inches [375 mm] and above) are deflected to a smaller profile (approximately 50%) at the manufacturing plant. The PVC Alloy Pipeliner™ does not shrink longitudinally or radially after installation (memory reset by heat and stretching to new dimensions) to achieve a tight fit. The material has very high abrasion resistance and ductility. Ultraliner's base materials are NSF 61 listed, but the system has not yet been certified by NSF 61.

For gravity applications, the PVC Alloy Pipeliner can be considered a fully structural, independent liner with flexural modulus ranging from 145,000 psi (10,000 bar) (F1871) to 280,000 psi (19,310 bar) (F1504). However, there are no long-term pressure regression test data available to support its use as a fully structural pressure pipe liner. The liner has been used for low pressure applications (up to 80 psi [5.5 bar]) as a semi-structural liner (Class II) in diameters up to 15 inches (375 mm). Like most PVC products, the modulus and long-term properties need to be re-rated downwards at temperatures above 80°F. The design of the liner is based on the appendix in the two standard practices, ASTM F1867 and F1947, which are identical to Appendix X1 in ASTM F1216.

For installation, access is required at both ends. The host pipe is cleaned and the Pipeliner is pulled into the existing pipe. Once in place, both ends are plugged and the Pipeliner expanded with steam and air pressure to reset the PVC alloy's memory. Installation and processing of the liner takes 4 to 5 hours, excluding any time needed to reinstate fittings and connections, and demobilization. Excavation is required to reinstate fittings (valves, hydrants, connections) and special fittings are needed to seal the liner to the existing pipe.

PVC Alloy Pipeliner tends to be more competitive on small-scale projects (short lengths, small diameter) given low mobilization and setup costs compared to other trenchless rehabilitation methodologies such as CIPP. Large scale (>25,000 feet or 7,622 meters) 8 inch (200 mm) PVC Alloy projects can receive bids in the \$22 to \$25 per linear feet range, while smaller scale 8 inch projects can see prices in the \$40 per linear feet range.

EX Pipe

Miller Pipeline offers a fold-and-form PVC pipe called EX Pipe. EX Pipe is a high strength, unplasticized PVC manufactured to meet ASTM F1504. EX Pipe is only available in diameters of 6 to 15 inches (150 to 375 mm) and has never been used in a pressure application according to Miller Pipeline. EX Pipe is only installed by Miller Pipeline crews. The EX Pipe is softened with heat in a pipe warmer trailer and then continuously inserted into the host pipe via manholes or other access points using a winch. After insertion, using steam and air pressure, the pipe is expanded approximately 10% to fit tightly within the existing pipe. Pressure is maintained until the liner cools down to 100°F. The liner can be installed through 90° bends and small diameter changes. Although Miller Pipeline has not offered EX Pipe for pressure applications (also does not have an NSF 61 listing), the pipe does have a flexural modulus of 340,000 psi (23,448 bar) and tensile strength of 6,000 psi (414 bar) which is only 25% below that of standard PVC pressure pipe. It would appear reasonable that with some long-term pressure regression testing, EX Pipe would have a market for low pressure rehabilitation in sewer force mains. But without this testing, EX Pipe cannot be considered a viable rehabilitation candidate for sewer force mains at this time.

AM-Liner II®

Produced by American Pipe & Plastic, AM-Liner II has been installed in over 100 miles of gravity sewers, but has not been used in any pressure applications. AM-Liner II is available in diameters of 6 to 12 inches (150 to 300 mm) and SDRs 26 to 32.5 and conforms to ASTM F1871 (Type A Folded/Formed PVC Liner).

On-Site Expandable PVC Close-Fit Lining

Duraliner™

Duraliner from Underground Solutions is a patented, stand alone structural liner (Class IV) made of PVC and available in diameters of 6 to 30 inches (150 to 760 mm). Duraliner is NSF 61 certified, so it also is acceptable for potable water applications. Duraliner is a PVC pipe that meets all of the requirements of AWWA C900 and C905 prior to modification by expansion. The final product meets the requirements of AWWA C909.

The outside diameter of the starting PVC pipe stock is sized smaller than the inside diameter of the host pipe. Sections of the Duraliner pipe are then butt-fused together forming a continuous pipe. The pipe is then inserted into the cleaned and previously inspected host pipe. Special end caps are fitted to the ends of the pipe along with temperature sensors. The PVC pipe is heated with steam, and then pressure is applied to expand the material tightly against the walls of the host pipe. It takes approximately 90 minutes to fully expand the stock pipe. After cooling, the end fittings are removed and the expanded new pipe cut to length and reconnected to the system. Insertion lengths ranging from 700 to 1,500 feet (213 to 457 meters) are possible. The liner can even navigate through a 45° elbow. The expansion of the PVC reorients the molecular chain in the circumferential direction, thereby increasing the tensile strength.

Underground Solutions states that the HDB increases from 4,000 to 7,100 psi (276 to 490 bar). This more than compensates for the reduction in wall thickness caused by the expansion. Molecularly oriented polyvinyl chloride (PVCO) pipe has been used in Europe for over 20 years.

3.4.4 Cured-In-Place Pipe. The first installation of a CIPP product was in a 70 m length of 1,175 × 610 mm brick sewer in Hackney, East London. It was installed in 1971 and a small number of other projects were undertaken by the inventor Eric Wood, and his partners Doug Chick and Brian Chandler, who formed Insituform Pipes and Structures, Ltd. before they licensed Edmund Nuttalls, a civil engineering contractor in 1973. Nuttalls Permaline Division performed approximately 380 projects before they were bought back by Insituform Group in 1986. It is estimated that about 40,000 miles of CIPP liners have been installed worldwide, perhaps 25,000 by Insituform companies.

It is by far the leading method for the rehabilitation of gravity sewers. With the expiration of the original patent on CIPP, many new variants have been introduced. Figure 3-17 highlights the main differences based on tube construction, method of installation, curing method, and type of resin.

The original CIPP product was a needled felt tube, impregnated with polyester resin, which was inverted into a sewer through a manhole and cured using hot water. Insituform still markets this product today for gravity sewers. Interestingly, the developer of the original CIPP product was actually trying to develop a liner for rehabilitating pressure pipes. However, they found it easier to get trials in gravity sewers so the pressure aspect was forgotten until some 20 years later. Now, a multitude of new CIPP products can be classified as either semi-structural or fully structural for pressure applications. A few also have an NSF 61 listing and can be used for potable water.

For this report, discussion of the relevant technologies is organized into non-structural, semi-structural, and fully structural CIPP as outlined below. The tube construction, installation method, cure method, and resins used are discussed for each CIPP technology.

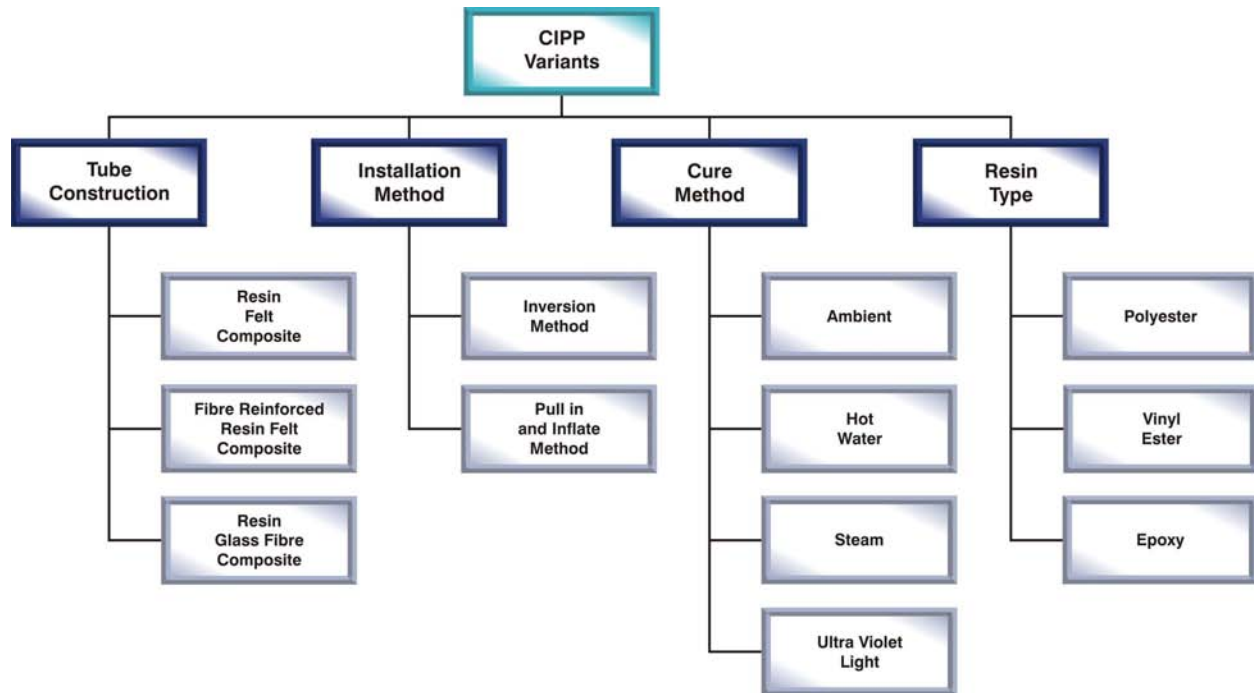

Figure 3-17. Summary of CIPP Technologies

3.4.4.1 *Non-Structural to Semi-Structural CIPP Liners*

Hot Water/Steam Cured

Inliner[®] CIPP

Inliner was first introduced in 1986. Since its introduction, over 9 million feet (2.7 million meters) of Inliner have been installed. Inliner is supplied by Inliner Technologies, LLC (a Layne Christensen company) and is installed by Reynolds Inliner, LLC. Inliner is available in diameters of 4 to 120 inches (100 to 3,000 mm), with thicknesses ranging from 0.12 to 2.4 inches (3 to 66 mm). Inliner is not NSF 61 listed, so it is not suitable for potable water applications. Inliner offers its CIPP liner for pressure applications, with a maximum recommended pressure of 60 psi (4 bar).

However, no long-term pressure regression testing has been conducted to support a long-term design stress for the material. Inliner has been used in at least one force main (Largo, FL) where approximately 500 feet (152 meters) of an 8 inch (200 mm) DI main was lined. The DI main had corroded to the point where it collapsed in one area when stepped on by a maintenance person. The operating pressure in the portion of the lined main was reported to be less than 5 psi (0.35 bar). Inliner Technologies uses isophthalic polyester resin, epoxy vinyl ester and “enhanced” polyesters. The “enhanced” resin is a filled isophthalic polyester resin, which would increase stiffness, but sacrifice some strength and chemical resistance. The flexural modulus of the standard isophthalic is 250,000 to 380,000 psi (17,241 to 26,207 bar), while the enhanced ranges from 400,000 to 450,000 psi (27,586 to 31,034 bar). However, flexural and tensile strength is slightly lower for the “enhanced” resin. The felt tube is made of a non-woven needled felt made of polyester fibers. An outer layer of impermeable thermoplastic material (polyethylene or polyurethane) is used to protect the resin from water and contaminants. Inliner can be installed using the inversion or pulled-in-place method. For inversion, the tube is inflated with either water or air pressure. If using the pull-in-place method, a calibration hose or removable bladder is inverted inside the felt tube after the tube is pulled into place. Curing is by either hot water or steam.

3.4.4.2 *Semi-Structural CIPP Liners*

Hot Water/Steam Cured

Insituform PPL[®] (Pressure Pipe Liner)

PPL was first introduced in 1995. Since then, 44 miles of PPL has been installed in the US. The interactive liner is available in diameters from 8 to 60 inches (200 to 1,500 mm), with the ability to span over small holes and gaps in a host pipe for pressures up to 200 psi (13.8 bar). Insituform has a special epoxy resin that is NSF 61 certified for potable water, otherwise vinylester is used. The tube is made of Insituform's standard non-woven felt tube, but with some special glass reinforcement included for added tensile and flexural properties. The initial flexural modulus of PPL is 250,000 psi (17,241 bar) and flexural strength is 6,500 psi (448 bar). For spanning over holes, the flexural strength is reduced to one third of the initial value for long-term performance. In addition, a factor of safety of 2 is utilized. The PPL sock is saturated either in the factory or on site. The tube is then positioned in the existing pipe using water pressure to invert the tube inside out and to form a close-fit. PPL can be installed in lines with bends up to 90°. Typical renewal lengths are from 200 to 1,000 feet (61 to 305 meters). After positioning, the tube is cured with circulating hot water. After curing, the liner is allowed to cool down to 90°F. The ends are cut and sealed using expandable stainless steel bands and elastomeric seals. After installation, the liner is CCTV inspected for any abnormalities. Samples are collected and tested to confirm that the physical properties meet the design assumption. Also, a pressure test to twice the operating pressure, or operating pressure plus 50 psi (3.4 bar) (whichever is least), is recommended.

National Liner[®]

National Liner was introduced in 1995. National EnvironTech Group, the technology supplier for National Liner, reports that over 200 miles of liner have been installed, with most of that for gravity sewer applications. National Liner has only been used for pressure pipe installations in the past few years. Two of the nationally licensed contractors have both reported using National Liner for sewer force main applications. National Liner does not have a NSF 61 listing, so it is not suitable for potable water. National Liner is available in diameters of 6 to 120 inches (150 to 3,000 mm), with wall thicknesses ranging from 4.5 to 33.5 mm (0.18 to 1.34 inches) with the standard felt tube. Greater thicknesses are reportedly possible. The liner is made of a non-woven, needled polyester felt that is shop or site impregnated with a polyester resin. For pressure applications, a vinylester resin is used. National EnvironTech Group offers a maximum operating pressure of 50 psi (3.4 bar) with its standard felt tube, but higher pressures with a new glass fiber composite tube are reportedly under development. The liner with a felt tube would be considered a semi-structural liner (Class II/III), and, with the glass fiber, considered a fully structural liner (Class IV). National Liner is installed using the inversion method, with either a column of water or pressurized air. Either hot water or steam is used for cure depending on the method of inversion. Any excess resin mechanically locks the tube to the host pipe by filling in cracks.

3.4.4.3 *Structural CIPP Liners*

Paraliner PW and Paraliner FM

A relatively new product, Paraliner was introduced by NOVOC Performance Resins, LLC in October 2007. Approximately 10,000 feet (3,049 meters) of potable water mains were lined with Paraliner PW in 2008. The liner is available in diameters of 6 to 96 inches (150 to 2,400 mm) and with thicknesses from 0.18 to 2.07 inches (4.5 to 52 mm). Paraliner PW or FM is impregnated by the installation contractor with a 100% solids NOVOC vinyl ester resin that contains no styrene. The "green" solution has no EPA reportable components and is NSF 61 certified (by Underwriters Laboratory [UL]) for use in potable water. As a result of no styrene, curing times are reduced 30% to 50% over conventional CIPP liner. Minimal shrinkage due to 100% solids also ensures a tight fit to the host pipe. The tube consists of one or

more layers of absorbent non-woven felt fabric, with some fiberglass added for enhanced properties. The outside layer of the tube is coated with an impermeable, flexible membrane that contains the resin. The reported physical properties are impressive, with a flexural modulus of 940,000 psi (64,828 bar), flexural strength of 16,000 psi (1,104 bar) and tensile strength of 16,000 psi (1,104 bar). However, NOVOC reported a burst pressure in an 8 inch sample with a 6 mm (0.24 inch) wall of 230 psi (16 bar). This only equates to a hoop tensile strength of 3,833 psi (264 bar), far lower than the 16,000 psi (1,104 bar) claimed. Prior to installation of the liner, the host pipe must be well cleaned using mechanical scrapers or power boring. The liner can either be installed by inversion or pulled into place by a winch. With inversion, the liner is cured using hot water. If pulled into place, the liner is inflated with air and then steam cured. Thermocouples are used in either case to monitor the exothermic reaction. The liner can be installed through an elbow of up to 45°. After cure, the liner is allowed to cool down to 100°F before relieving any pressure and then the ends are cut and sealed using Weko-Seals, or an equivalent. Service connections can be reinstated robotically, but all large connections and fittings must be excavated and reinstated using mechanical fittings. Depending on diameter, the maximum renewal length would be 1,000 feet (305 meters). In addition to CCTV inspection, pressure testing to 120% of the working pressure is recommended after completion of the lining.

Insituform RPP™ (Reinforced Pressure Pipe)

Insituform RPP was first introduced by Insituform Technologies in 1998 and, since then, 19 miles of the custom engineered CIPP product has been installed. RPP is designed to restore the structural integrity to distressed pressure pipes and prevent internal corrosion and/or erosion. It is a fully structural (Class IV) liner capable of carrying the full internal pressure and external load. Insituform RPP is available in diameters of 8 to 72 inches (200 to 1,800 mm), with thicknesses up to 1 inch (25 mm). RPP is not suitable for potable water applications. Insituform RPP has been used on several sewer force main projects. The datasheet in Appendix A contains information on two force main installations. A maximum pressure of 80 psi (5.5 bar), diameter dependent, is recommended by Insituform Technologies. The design of Insituform RPP is predicated upon ASTM F1216, Appendix X1.3.2 for the fully deteriorated pressure pipe condition. The initial tensile strength of the liner is 6,000 psi (414 bar). For internal pressure design, a long-term tensile strength equal to one third of the initial value is used, along with a factor of safety of 2. Insituform Technologies has carried out some limited long-term pressure regression testing, but has not yet met the ASTM log time distribution requirements. The CIPP tube is a sewn tube consisting of two or more layers of absorbent non-woven synthetic fiber combined with glass fiber reinforcement. The outside layer of the tube is coated with a translucent flexible plastic material for visual inspection during resin impregnation. A vinyl ester resin is used. The interior must be very clean with no protrusions. Inversion lengths of 200 to 1,000 feet (61 to 305 meter) can be achieved and elbows of up to 45° negotiated by the liner. After curing, the ends are cut and sealed using expandable stainless steel bands and elastomeric seals. A pressure test of twice the operating pressure, or operating pressure plus 50 psi (3.5 bar), whichever is less is recommended. The limit on make-up water is 20 gallon/inch diameter/mile/day.

Nordipipe™

Nordipipe was first introduced in Sweden in 2002, later in Hong Kong, and then more recently in Canada. Through 2008, there have been no installations in the US. Norditube Technologies, the US promoter of Nordipipe, is a subsidiary of Sekisui-CPT Company. It is estimated that about 12 miles of Nordipipe are being installed each year. Nordipipe is a fully structural CIPP product that incorporates a glass fiber reinforced layer (chopped strand mat) between two non-woven felt layers. The tube is impregnated with either epoxy (potable water) or vinyl ester resin. A PE coating is on the interior, which allows Sekisui to have an NSF 61 listing for potable water applications (BNQ in Quebec) when used in conjunction with the epoxy resin. The vinyl ester resin is roughly half the price of the epoxy. Nordipipe is available in diameters from 5 to 48 inches (125 to 1,200 mm), with thicknesses from 0.18 to 0.94 inches (4.5 to 23.5 mm). The pressure rating of the liner is dependent on diameter and ranges from 250 psi (17.2 bar) for a 6

inch (150 mm) liner down to 60 psi (4 bar) for a 48 inch (1,200 mm) liner. The pressure rating and diameters would cover over 75% of the sewer force mains in the US. Sekisui reports that they lined a 12 inch (300 mm) sewer force main in Hamburg, Germany using vinylester resin and a 16 inch force main in the UK, with epoxy. There is currently no ASTM product standard. The design of the CIPP liner would be predicated on Appendix X1 of ASTM F1216. The CIPP liner is installed via inversion, using air pressure or a water column, and is cured with either steam or circulating hot water. Up to 600 feet (183 meters) can be installed and elbows up to 45° navigated by the liner during insertion.

Berolina Liner

One of the latest glass reinforced CIPP liners to enter the US market is Berolina Liner from BKP Berolina Polyester GmbH in Berlin, Germany. BKP Berolina has licensed the CIPP Corporation to be the sole nationwide US provider of this new liner. The liner was first used in Europe in 1997 and then outside Europe beginning in 2001. There have not been any US installations yet, but Berolina Liner has been used in Canada (Hamilton, Ontario). The Berolina Liner is composed of glass fiber and/or polyester webs impregnated with polyester or vinylester resin. Uniquely, the layers are overlapped and staggered giving the tube variable stretching capability. After placement of a protective film sleeve covering the lower half of the host pipe, the liner is installed by pulling it in place, which can be accommodated by the axial strength of the glass fiber. The tube is calibrated by inflating with compressed air (7.5 psi [0.5 bar]) and can be inspected with a CCTV camera before polymerization. Once it is confirmed that the liner is correctly placed, it is then ultraviolet (UV) cured. The liner has a protective inner film and a UV-resistant outer film. The inner film is removed after installation. The outer film prevents resin from migrating into laterals, but also from entering cracks in the host pipe. The outer film also prevents styrene emissions. A renewal length of up to 1,200 feet (366 meters) is possible. Interestingly, the Berolina Liner is designed with ring stiffness classes of SN1250 to SN10000 (MPa), which equates to the same ring stiffness classes in AWWA C950 for direct buried GRP pressure pipe (namely SN9 to SN72 psi). As yet, BKP Berolina has not undergone any long-term pressure regression testing per ASTM standards, which could be used to establish a hydrostatic design basis, as is done for glass reinforced plastic (GRP) or thermoplastic pressure pipes. BKP Berolina claim they have done considerable long-term testing per European and Japanese standards, but no data have yet been produced. They have done 10,000 hour creep tests. Also, Berolina Liner did have the lowest permeability of all CIPP liners when tested by IKT in Germany in 2008. The Berolina Liner is available in diameters from 6 to 40 inches (150 to 1,000 mm) with thicknesses ranging from 0.08 to 0.47 inches (2 to 12 mm). BKP Berolina's newest liner, called Berolina-LP-Liner (low pressure), is currently undergoing testing and will be introduced for pressures up to 45 psi (3 bar). This will probably accommodate 50% of the sewer force main market. The Berolina Liner conforms to the European standard, EN 13566-4, and the draft International Organization for Standardization (ISO)/DIS 11296-4. As yet there is no ASTM standard for this product, but work is underway preparing a new standard that will cover this type of product. The design basis for this liner is either ASTM F1216 Appendix X1 or the German standard ATV-M 127-2. This German standard is well known in Europe, but has limited value in the North American market. BKP Berolina does have an impressive list of QA/QC requirements that are performed in their factory on the liner (some are qualification or type tests), as well as recommended QC tests after installations. The technical datasheet in Appendix A contains details on these requirements.

Blue-Tek®

Brandenburger GmbH, located in Landau, Germany, was an early developer of resin pre-impregnated laminates (prepregs) for sewer rehabilitation that used UV light curing. In 1997, Brandenburger formed UV Reline.tec GmbH and began the promotion of their technology outside Germany. Brandenburger now has affiliates in the US, Canada, UK, and Mexico with over 5 million feet (1.5 million meters) installed in 24 countries around the world. Reline America, Inc., located in Saltville, VA, was established in 2007 to distribute the Blue-Tek CIPP liner to licensed contractors. Reline America now claims they have made significant improvements in the original technology and are transferring that know-how back

to Brandenburger. The product is called Blue-Tek in Germany, Eco CIPP in the UK and UV CIPP in some other countries. Blue-Tek is primarily marketed for gravity sewer applications. Blue-Tek does not have NSF 61 certification, so it's not suitable for potable water applications. Application for NSF 61 is being considered for the future. Blue-Tek is a glass reinforced CIPP liner that is UV-cured. The liner strength stems from a seamless, spirally wound glass fiber tube that is impregnated with polyester (ortho) or vinyl ester resins. All wet out is performed in the Saltville plant. The seamless liner has an inner and outer film, with the outer film blocking UV light. Care is needed to ensure the outer film is not damaged during installation. The inner film is removed after curing. The glass reinforcement used is Owens Corning's Advantex[®] EC-R glass, which is a highly acid resistant glass fiber. Blue-Tek is available in diameters from 6 to 48 inches (150 to 1,200 mm) and can be used in circular, oval, and egg-shaped pipes. Reline America reports that liners up to 60 inches (1,500 mm) will be available in the near future. The short-term flexural modulus is 1.1×10^6 psi (7.6×10^4 bar), with increases to 2.16×10^6 psi (14.9×10^4 bar) possible. For long-term modulus, a reduction factor of 1.6 is used. The short-term tensile strength is reported to be 20,000 to 26,000 psi (1,379 to 1,793 bar). No long-term test data are available which limits the Blue-Tek liner to semi-structural applications. The product conforms to ASTM F2019 and would be designed in accordance to ASTM F1216, Appendix X1. Renewal lengths of up to 1,000 feet (305 meters) are achievable. Blue-Tek is winched into the existing pipe and inflated with air pressure (6 to 8 psi [0.4 to 0.55 bar]) and then cured using a UV light train. Reline America promotes its Quality-Tracker[™] System for tracking the entire curing process (seven steps) with a data logger and retrieval system. In addition to CCTV inspection of the line before and after curing, a record of the liner's inner air pressure during curing, the curing speed (feet/min), and resin reaction temperatures (infrared sensors) are all monitored. Reline America claims that minimal styrene is released into the environment with their process.

InsituMain[™] by Insituform Blue

In 2009, Insituform introduced its latest addition to their CIPP product line referred to as InsituMain. InsituMain is a fully structural Class IV CIPP liner that has an NSF 61 certification and is suitable for both potable and non-potable pressure applications, including sewer force mains. InsituMain is available in nominal diameters of 6 to 36 inches (150 to 900 mm) and for pressures up to 150 psi (10 bar). The InsituMain system has a polyethylene layer on the inside pipe surface that increases the pipe's smoothness, reduces surface friction, minimizes reduction in flow, and provides an additional corrosion barrier for the pipe. It is composed of an epoxy composite layer, which is reinforced with glass and/or polyester fiber materials (depending on a number of design elements including the host pipe diameter and internal pressure requirements). The InsituMain product is saturated with epoxy resin, either on the job site or in an authorized wet out facility, inserted into the host pipe either by inversion or by pulling-in, and cured with either hot water or steam. The InsituMain system, which adheres to the host pipe, provides a continuous, structural pipe. Because the liner does adhere to the host pipe, special fittings to seal the ends are not required.

3.4.5 Woven Hose Lining System. Woven hose linings differ from ordinary CIPP products by the construction of the tube reinforcement. Rather than being made of a felt type material, hose liners are made from either polyester, glass, or aramid fibers that are woven into a hose-type configuration, similar to the type of construction used for fire hoses. The weaving pattern can be varied to give different properties in the circumferential and axial direction. Typically, hose liners are pulled into place rather than installed by inversion as they have relatively high axial strength. Three types of woven hose lining systems are discussed below including adhesive-backed linings, non-adhesive backed linings, and glass-reinforced thermoplastic linings. It is also noted whether or not the lining system is semi-structural or structural in nature.

3.4.5.1 Adhesive-Backed Woven Hose Lining

Semi-Structural (Class II, III) Woven Hose Lining

Starline® HPL-S

Karl Weiss Technologies, located in Berlin-Zehlendorf, Germany, has developed a complete line of CIPP products for the gas, water, and wastewater industries. For natural gas applications, Karl Weiss has been working with the Gas Technology Institute (GTI) to refine and test a new High Pressure Liner (HPL). The Starline HPL-G liner was first installed in 2004 in the US. Karl Weiss reports that Battelle carried out long-term tests demonstrating the suitability of the liner for gas pipes in the US. The hose liner, based on an epoxy resin system, has been tested in accordance with the German standard DVGW VP 404, which includes aging strength, fluid strength, sealing characteristics, peel strength, and creep strength against internal pressure. The German Association of Gas and Water (DVGW - Deutsche Vereinigung des Gas und Wassersfaches e.V.) has certified the liner for a maximum pressure of 430 psi (30 bar) with a 50 year lifetime, according to Karl Weiss. By modifying the liner coating, the HPL liner is also available for drinking water transmission. Starline 1000 (see Figure 3-18) is the liner designated for drinking water applications in Germany. It is available in diameters of 3 to 24 inches (75 to 600 mm). Although the liner meets the German DVGW W270 Recommended Practice for Drinking Water and the KTW recommendations of the Federal Institute of Health (Bundesgesundheitsamt), the application for NSF 61 certification has only been initiated with approval expected in 2010. Starline 3000 UV is a liner that is designed to be fully self-supporting, not dependent on the adhesion of the liner to the host pipe. It is also UV-cured. Starline HPL-W and Starline HPL-S are Karl Weiss's equivalent to the high pressure gas pipe, except these are designed for drinking water and wastewater applications and in particular where long installation lengths are needed.



Figure 3-18. Starline® 1000

Structural (Class IV) Woven Hose Lining

Aqua-Pipe®

Sanexen Environmental Services of Quebec, Canada, in conjunction with the National Research Council (NRC) of Canada, developed the new structural hose liner Aqua-Pipe primarily for use in potable water applications (Figure 3-19). Aqua-Pipe have both the BNQ Standard 3660-950 certification (Canada) and NSF 61 certification for use in drinking water systems. The majority of early installations were in Eastern Canada, principally Quebec Province, with a later introduction to the US in 2004. To date, over 800,000 feet (243,902 meters) of Aqua-Pipe has been installed in North America. Aqua-Pipe is composed of two concentric, tubular, plain-weave polyester jackets with the inner jacket bonded to a polyurethane elastomer. This watertight tubular elastomer membrane is compatible with drinking water. The polyester jackets are impregnated with epoxy resin on site in refrigerated trucks. The Louisiana Tech University TTC has been running tests on Aqua-Pipe for Sanexen. Based on this testing, the physical properties of the Aqua-Pipe liner are reported to be higher than the minimums in ASTM F1216 and/or F1743. The flexural modulus is 290,000 psi (20,000 bar). The flexural strength is 6,500 psi (448 bar) and the tensile strength is 8,700 psi (600 bar). The tensile strength in particular is nearly three times the ASTM minimums. The TTC has also carried out a combination of creep tests (to obtain creep

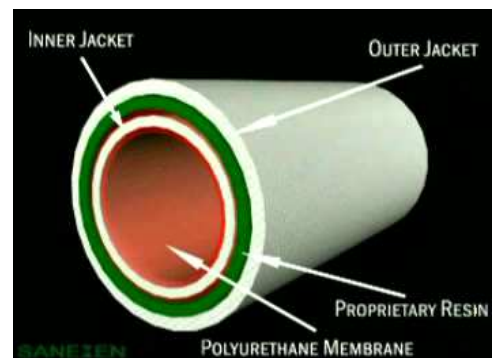

Figure 3-19. Aqua-Pipe Construction

coefficients for a three-dimensional [3-D] finite element analysis modeling for long-term performance) and a 500,000 pressure cycles test (60 to 120 psi [4 to 8 bar]), which has given the combined effect of creep and fatigue. TTC also reported that the testing has demonstrated that ASTM D 2207 is a reasonable design approach for relining of pressure pipes with CIPP liners. They found the behavior of the resin-fiber composite under cyclic loading to be interesting (measured both deformation and strain) and will be reporting the results later in 2009. Aqua-Pipe is available in diameters of 6 to 12 inches (150 to 300 mm) with larger diameters planned in the future. The liner is structural and is custom designed to handle up to 150 psi (10 bar) operating pressure and 6 feet (1.8 meters) of soil cover. The excess resin bonds the liner to the host pipe, filling any small holes or cracks. The hose liner is installed by pulling in place pipe (PIPP) with lengths of up to 500 feet (152 meters) between access pits possible. After CCTV and cleaning the main, any service connections are mapped and plugged robotically with small plastic caps. This is to keep the excess epoxy resin from plugging the service connection. A calibration pig is driven through the liner using water pressure, which presses the liner tightly against the host pipe. Hot water is circulated through the liner to cure the epoxy resin. After cure, a robotic tool is positioned at each service connection and a hole is precisely drilled through the liner and the plugs removed to restore service.

3.4.5.2 Non-Adhesive Backed Woven Hose Lining

Structural (Class IV) Woven Hose Lining

Saertex-Liner® (Lightstream)

Saertex multiCom GmbH, located in Saerbeck, Germany, first introduced its CIPP liner in Europe in 1996 and later in the US in 2007. The only licensed installer of Saertex-Liner in the US is International Pipe Lining Technologies (IPLT) in California. IPLT calls the Saertex liner Lightstream. The global utilization rate of Saertex-Liner has been about 100 miles per year since 2008. The Saertex-Liner is available in diameters of 6 to 48 inches (150 to 1,200 mm) and with wall thicknesses of 3 to 12 mm (0.1 to 0.5 inches). The hose liner is not marketed for pressure applications and does not have an NSF 61 certification. Like many of the other fully structural CIPP liners, Saertex-Liner's structural portion is made of several layers of Advantex E-CR glass fiber reinforcement impregnated with either a polyester or vinylester resin. The glass fiber is woven into a hose by Saertex in Germany and shipped to a US warehouse in Littleton, Colorado. The liner has an inner, styrene-tight film, which is removed immediately following the curing process. An external styrene-tight film, along with an opaque film that protects against UV exposure and damage during installation forms the outer surface. The liner is winched into place after placing a sliding film along the invert of the host pipe. The liner can be either UV-cured or steam cured (catalyst included for steam curing option). Saertex liners range from semi-structural to fully structural for gravity applications and are produced in two classes: Saertex-S and Saertex-M. The flexural modulus of the S-liner is 1.74×10^6 psi (12×10^4 bar), and its flexural strength is 36,250 psi (2,500 bar). For long-term flexural modulus properties, a diminution factor of 1.35 is recommended for the S-liner. The M-liner has a lower flexural modulus and strength (see the datasheet in Appendix A for details). Unfortunately, Saertex multiCom has published no tensile strength data for its liners as they have not yet offered their liners for pressure applications. From what little data are available, the Saertex-Liner appears to have similar strength and stiffness levels to other CIPP pressure products. However, the use of Saertex-Liner for sewer force main applications, although technically possible, would have to be considered experimental at this time.

Primus Line®

Primus Line is an emerging new technology from Raedlinger Primus Line GmbH of Cham, Germany. Primus Line was introduced in Germany in 2001. Raedlinger reports that it has been supplying between 20 and 30 km of Primus Line each year since 2008, but all of this is located in Germany. Primus Line is available in diameters from 6 to 20 inches (150 to 500 mm) with thicknesses ranging from 6.5 to 9 mm (0.3 to 0.4 inches). It has been certified for drinking water applications in Germany, but not yet in the

US. Primus Line is a seamless, woven hose made of aramid (Kevlar[®]) fiber in single or double layer designs (depending on pressure) embedded in a high performance plastic matrix. Kevlar has eight times the tensile strength of steel. The folded pipe is pulled into an existing pipe from a reel. This is not a CIPP product so no curing is required. Pressure is used to inflate the liner which then becomes self-supporting. For water or sewer applications, the inner liner is coated with polyethylene. There is also an outer coating of wear resistant PE. Primus Line is also used for oil and gas applications in which the liner is coated with TPU. The main benefit of Primus Line is its ability to handle high pressure. With a single layer of woven fabric, the pressure rating for 6 inch (150 mm) diameter is nearly 500 psi (34.5 bar) and for 20 inch (500 mm) diameter it is rated at 218 psi (15 bar). The rating can be higher with a double fabric layer. Primus rates its product based on a factor of safety of 2.5 against the burst strength, but also claims that long-term creep pressure tests have been conducted in accordance to DIN 16887 and ISO 9080. The product has a safety coefficient of 2.0 applied to the extrapolated 50 year strength. The only available product standards for Primus Line are German, namely KTW and W270 for drinking water in Europe, and DVGW Testing Basis VP 643 (June 2004). For insertion, the existing pipe must be CCTV inspected and any sharp protrusions that might damage the liner are ground smooth. The Primus Line is pulled from a reel (up to 6,000 feet [1,829 meters]) into the pipeline. A special pulling head is used to help protect the liner from any remaining sharp objects. The rate of installations can be up to 1,200 feet (366 meters) per hour. The maximum pulling force is 100 kilo Newtons (kN) and a load cell with recorder is used to monitor that this force is not exceeded. The main drawback of the Primus Line is that a very special, proprietary connector is needed to join the line to a welded or flanged connection on the original pipe. This special connector requires a resin to be injected and cured before the line can be pressure tested and put back into service. One potential application for the Primus Line might be as a by-pass pipe. It is very light weight (1.6 to 9.1 kg/m), quick to unreel, and set up.

3.4.5.3 *Glass-Reinforced Thermoplastic Liner*

Structural Woven Hose Lining

Aqualiner

Aqualiner is an emerging technology that appears to have great promise. It is still undergoing development trials in Europe and has not yet been commercially released. The developer, Aqualiner, is a consortium of three UK water companies, a Danish contractor, and a plastics consultant. All of the field trials have been with Wessex Water in the UK. The Aqualiner installation process is shown in Figure 3-20. Aqualiner involves winching a glass fiber reinforced polypropylene sock into a deteriorated pipe, and once the sock is in place, pushing a heated pig with a silicone rubber inflation tube through the sock, melting the thermoplastic sock against the pipe wall. The inversion bag presses the molten thermoplastic composite sock against the pipe wall where it cools to form a solid glass reinforced thermoplastic liner. Pressure in the inflation bag is kept at 45 psi (3 bar) until the liner cools, at which point the bag is deflated and removed. There is no mixing of chemicals and no environmental releases. The liner is fully structural (Class IV), capable of handling the internal pressure, and external loads. An application for UK approval for potable water is in process (DWI Regulation 31) as well as for certification for NSF 61. Aqualiner will also be able to meet the strain corrosion requirements of Table 6 in EN 13566-4:2002, which is similar to those in ASTM D3262. Aqualiner will be available in diameters of 6 to 12 inches (150 to 300 mm) (eventually 18 inches [450 mm]) and will have a 150 psi (10 bar) pressure rating. Renewal length of up to 500 feet (152 meters) for 12 inch (300 mm) pipe can be undertaken. There are no product standards yet for this new class of liner product. The closest applicable standard might be EN ISO 15874 *Polypropylene for Hot and Cold Water Installations*. Likewise, there are no design standards, with EN 13566-4:2002, *Plastic Piping Systems for Renovation of Underground Sewerage Networks (CIPP)* the most applicable.

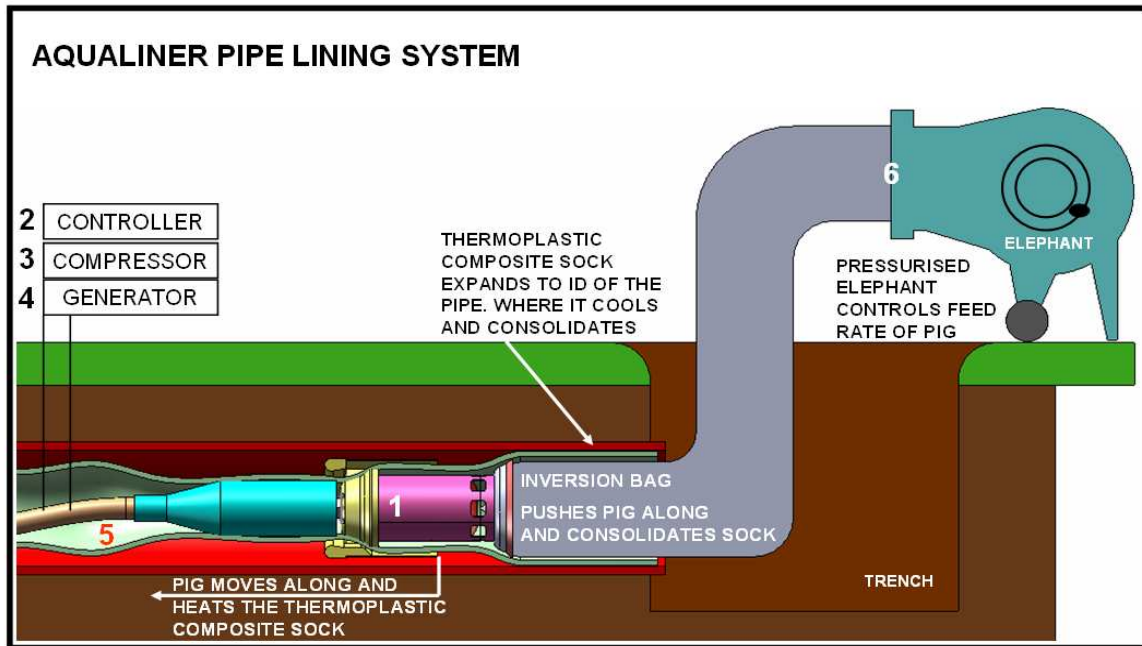

Figure 3-20. Aqualiner Installation Process

3.5 Replacement

Replacement is a form of renewal. Replacement involves the installation of a new fully structural pipe to take over the functions of the deteriorated main. Several technologies are available for online and offline replacement as summarized in Figure 3-21. Historically, the most common method of rehabilitation has been offline replacement of an underground main by open cut construction. While it is expensive, offline replacement has several benefits for the operating utility as follows:

- It results in a new pipeline with known condition and designed to current standards.
- Offline replacement can be undertaken with the existing force main in operation so there is no disruption to service.
- Offline replacement offers the opportunity to build parallel to the existing line in order to create some redundancy, allowing future inspection and maintenance works to be undertaken, while maintaining service.
- Cost may not be much higher than rehabilitation when the cost of by-pass pumping during rehabilitation is taken into account.

Fortunately, new trenchless methods of construction have yielded a wide variety of replacement methods that now limit the amount of excavation required to a minimum. These trenchless methods fall into both online and offline methods. Online is where the new pipe is laid to the same line and grade as the deteriorated pipe being replaced. With online replacement, by-pass of the existing pipe is needed during the replacement construction. Sliplining, pipe bursting, and pipe splitting are examples of online replacement. Offline replacement consists of installing a new pipe using a different line and possibly grade as the existing pipe. Normally, a by-pass of the existing pipe is not necessary with offline replacement. Once the new line is in place and has been leak tightness tested, flow is then diverted to the new line and the deteriorated main is retired from service. Directional drilling, microtunneling/pipe jacking, pilot tube boring, and auger boring are examples of trenchless offline replacement methods.

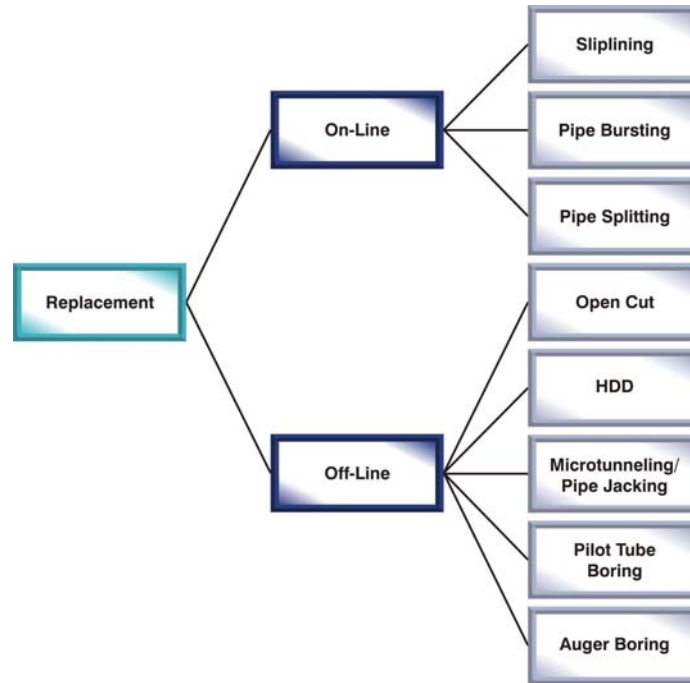

Figure 3-21. Summary of Replacement Technologies

3.5.1 Online Replacement. The following sections will cover the online replacement methods in greater detail and highlight some of the recent advances in the trenchless replacement technologies.

3.5.1.1 Sliplining. The second most common method of replacement has traditionally been sliplining, particularly for large diameter pipes. Sliplining involves the insertion of a new pipe with a smaller OD than the inner diameter (ID) of the pipe to be rehabilitated. Typically, the OD of the new pipe is a minimum of 2 inches less than the ID of the existing pipe. This can be relaxed for smaller diameters, straight runs, and when there are no offset joints that could interfere with the movement of the new pipe. The most common pipe material used for pressure sliplining has been PE. The PE can be in the form of a coil, a long welded string, or discrete lengths. Fusible PVC is now also gaining popularity as a slipliner. In large diameters, steel, DI, and GRP/FRP pipes have all been used as pressure slipliners. The new pipe can either be pulled or pushed into the existing pipe. The annulus between the two pipes is often filled with a low density grout to anchor the new pipe while increasing its buckling resistance.

Sliplining is a relatively low cost, easy method of installation that is not disruptive to adjacent utilities or structures. All connections and fittings require excavation for reinstatement. The main disadvantage is the reduction in flow capacity from downsizing the inside diameter. This can be offset to a certain degree by the improved flow properties (lower frictional resistance) that many new plastic sliplining pipes offer. Another disadvantage is the difficulty in finding any leaks that may develop in the new slipliner. Any water or sewerage could migrate long distances between the slipliner and the host pipe before exiting at a weak point in the host pipe. The external visible evidence of a leak could be far removed from the actual leak in the liner.

Fused Pipe Lengths

Polyethylene, with butt-welded joints, has been used extensively for replacement using the sliplining method. The axial strength of a butt-welded HDPE joint is equal to the material, so this makes HDPE ideal for pulling into an existing pipe. Polyethylene pipe is normally sized with the OD equal to the nominal diameter. However, on large projects, some PE vendors will tool up and custom manufacture a

pipe size that minimizes the interstitial gap and therefore loss of capacity. The thickness of HDPE can also be a negative factor for flow, especially for high pressure. An SDR 11 is needed for a 160 psi (11 bar) pressure rating and SDR 17 for a 100 psi (7 bar) pressure rating. Of course, this is based on using the pipe as a fully structural pipe since a slipliner is independent, not interactive, with the existing host pipe.

FusiblePVC™

In 2003, Underground Solutions introduced a patented PVC pipe product that could be butt fused together, much in the same manner as HDPE (Figure 3-22). Their first commercial installation was in January 2004 and since over 2 million linear feet (0.6 million meters) have been installed. FusiblePVC has been used in over 43 states, plus Canada and Mexico. The primary use has been for pressurized potable water, reclaim, and wastewater lines.



Figure 3-22. Fusion of PVC Joint

The resin and compound meets the PVC formulation in PPI Technical Report #2, so the same hydrostatic design stress may be used (2009). The fusible pipe meets both AWWA C900 and AWWA C905, is made in DI pipe size (DIPS) and iron pipe size (IPS) OD series, and is NSF 61 certified for use with potable water. With the proprietary formulation, the fused joint is nearly as strong (minimum 95%) as the pipe wall.

With the fully restrained butt-fused joints, FusiblePVC can be used for directional drilling, pipe bursting, and sliplining. The same equipment that is used for butt welding PE pipe can be used for PVC. However, the fusion temperature, time, and pressure are different and only technicians that have been trained and certified by Underground Solutions are permitted to fuse joints. Certification lasts one year.

Fusible C-900[®], designed for water distribution systems, is available in diameters of 4 to 12 inches (100 to 300 mm) with DRs of 14, 18, and 25. Fusible C-905[®], designed for water transmission systems, is available in diameters of 14 to 36 inches (350 to 900 mm) with DRs of 14, 18, 21, 25, 32.5, 41, and 51. AWWA C-900 and C905 incorporates a long-term factor of safety of 2 with no surge allowance. Transient pressure is added to working pressure for maximum pressure and is not to exceed 1.6 times the pressure class of the pipe. Underground Solutions also produces FPVC™, which is Fusible PVC in diameter dimensions other than the DIPS and IPS series in the AWWA standards.

For sliplining, the host pipe would be moderately cleaned and a CCTV inspection made. The degree of cleaning is not as stringent as for close-fit liners. Depending on site logistics, the Fusible PVC can be strung out and the joints butt fused above grade prior to insertion or butt fused in the ditch. The fused PVC is then winched into the host pipe, following the maximum recommended pull force which is based on either an axial stress of 2,600 psi (179 bar) or a factor of safety of 2.25 against joint strength, whichever is less. Sliplining lengths of 3,500 feet (1,067 meters) in a single pull have been completed.

Discrete Pipe Lengths

Some of the same diameter and thickness considerations apply when sliplining with discrete pipe lengths. Normally, discrete pipe lengths will have bell and spigot joints or coupling joints with an outside diameter greater than the barrel of the pipe. Often, it is the outside dimension of this joint that will control the nominal diameter for insertion. Some pipe manufacturers make a special low profile joint to facilitate the insertion. The process for the insertion of discrete pipe lengths is to set up and assemble each pipe joint one at a time in the ditch. Next, the column of pipe is jacked forward by the length of each pipe section, before making the next joint assembly. Discrete pipe sliplining is favored when job site logistics are not

favorable to stringing out a long line of butt-welded pipes. Some pipe materials also have joints that can be mechanically locked together. When this feature is invoked, the pipe string can be advanced by either pulling or pushing or a combination of the two, thereby increasing the length that can be sliplined from one access pit to the next. One of the limitations of using discrete pipe lengths is that rubber ring joints will normally only allow angular rotations ranging from about $1/2^\circ$ to 3.5° depending on material and diameter. Therefore, any deviations in the host pipe's joints exceeding these values may require special attention. Also, pipe lengths may have to be non-standard to accommodate short radius curves. For sewer force mains, PVC, DI and GRP/FRP pipes could all be used for discrete sliplining. Hobas Pipe USA, US Composite Pipe (Flowtite™), Ameron, and Future Pipe are manufacturers of large diameter GRP/FRP pipe that have been used for sliplining of both pressure and non-pressure wastewater lines (Figure 3-23). Pipe diameters from 12 to 144 inches (300 to 3,600 mm) are available.

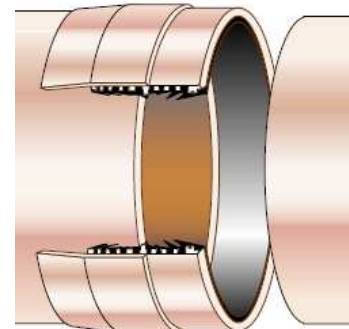

Figure 3-23. Hobas Sliplining Pressure Joint

In the case of PVC, Certainteed Corp. manufactures the Certa-Lok™ restrained joint for trenchless water and sewer applications. Certa-Lok is based on the use of a special coupling into which two nylon splines are inserted that lock into grooves in the spigot end of the pipe. A rubber gasket is included for water tightness. The C900/RJ and C905/RJ Certa-Lok PVC products are UL listed and suitable for pressure applications ranging from 150 to 200 psi (10 to 14 bar) dependent on DR ratio and standard. Certa-Lok pipe is available in diameters from 4 to 16 inches (100 to 400 mm). Another example of a restrained PVC joint is the TerraBrute™ pressure pipe from IPEX. The TerraBrute joint is a steel ring and pin system, that incorporates a rubber ring gasket for sealing. It is reported that the joint can take up to 120,000 lb of axial force in the 12 inch (300 mm) diameter size. The TerraBrute joint was specifically developed for horizontal directional drilling (HDD) applications, but can also be used for sliplining.

3.5.1.2 Pipe Bursting. Pipe bursting involves the breaking up of the old pipe and pushing it into the surrounding soil by passing a bursting or splitting device through it while pulling a replacement pipe in behind the bursting head. The replacement pipe is usually HDPE, PVC, or DI. In some cases, the process can be used to expand the void created, thus upsizing with the insertion of a larger diameter. For diameters 12 inches (300 mm) and under, upsizing up to 50% is possible and for diameters over 12 inches (300 mm) upsizing by up to 25% is achievable with the right soil conditions and adjacent structures far enough away to avoid damage. Upsizing by over 50% is considered experimental.

Pipe bursting has now been accomplished in diameters from 4 to 60 inches (100 to 1,500 mm). The bursting method works best on friable pipes, including CI, asbestos-cement, non-reinforced concrete, PVC, and clay pipes. There are three basic bursting methods — static, hydraulic and pneumatic bursting. Pipe splitting, which is a form of bursting for materials like DI and steel, is a fourth type that will be covered in the next section. Fusible PVC replacement pipe should only be used with the static bursting method.

The type of soil affects the ability of the bursting head to expand the hole and therefore the amount of upsizing. Obviously bursting is not possible in rock or pipes that are concrete encased. Also, shallow buried pipes risk surface displacement. As a general rule of thumb, the minimum depth of the existing pipe should be 10 times the difference in diameters of the existing pipe's OD and the expander's OD. With increasing depth of soil burial, the force needed to expand the hole also increases. The foundation of adjacent structures and other utilities can be damaged if too close to the bursting activity. The distance should be a minimum of 18 inches (450 mm) for normal bursting, larger for upsizing. Expansion pits can be dug adjacent to structures or utilities to relieve the soil pressure.

Since the original pipe is destroyed in the bursting process, the new pipe must be designed to carry all of the operational loads, including internal pressure, external soil pressure, and traffic loads. After insertion of the new pipe behind the bursting head, the soil will tend to close back on the pipe providing support. The design of the pipe is similar to direct burial pipe based on soil-pipe interaction. Actually, some of the most demanding loads may be exerted on the new pipe during the installation. The new pipe will see flexural loads as it enters the launch pit, axial tensile loads due to friction and pipe weight, external buckling pressure due to soil fill and groundwater, and possible surface damage from contact with shards of the old pipe.

Static Pipe Bursting

Static bursting was originally developed by British Gas to replace CI gas mains. It works well with CI and asbestos cement pipes. Pipe diameters from 2 to 60 inches (50 to 1,500 mm) can be burst using the static method, which relies upon brute force to shatter the existing pipe. Lengths up to 400 feet (122 meters) typically can be burst using the static approach although much longer lengths can be burst under the right combination of ground conditions and bursting equipment. TT Technologies Grundoburst® and Hammerhead Hydroburst® are two examples of equipment designed for static bursting, as illustrated in Figure 3-24.

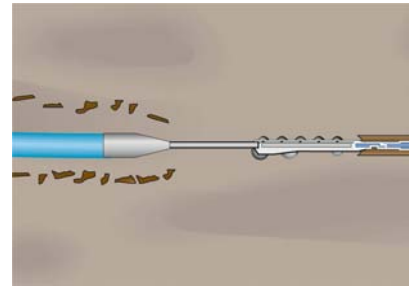

Figure 3-24. Static Bursting Head

Pneumatic Pipe Bursting

With pneumatic bursting, an air operated hammer shatters the old pipe with impact as the bursting head is pulled through the line. Pneumatic bursting works well with the same materials as the static method, plus PVC. Broken pieces are pushed outward by a rear expander, which can also upsize the resulting void. Diameters from 4 to 60 inches (100 to 1,500 mm) and lengths up to 500 feet (152 meters) typically are burst with the pneumatic method. TT Technologies Grundocrack® is an example of pneumatic pipe bursting equipment (Figure 3-25).

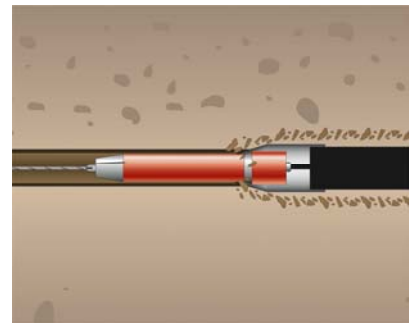

Figure 3-25. Pneumatic Bursting Head

Hydraulic Pipe Bursting

Hydraulic pressure is used to expand the burster, which breaks the old pipe and pushes the pieces into the surrounding soil. An expansion cone can also be accommodated for upsizing. The hydraulic method can be used with the same materials as the static method and in diameters from 6 to 20 inches (150 to 500 mm). Xpandit™ is an example of equipment designed for hydraulic pipe bursting.

Tenbusch Insertion Method

The Tenbusch Insertion Method (TIM™) deviates from the static and dynamic pipe bursting methods. Instead of using the bursting head to pull a new pipe into the void created by the burst, Tenbusch jacks the new pipe in place of the existing deteriorated pipe. The leading element is a heavy steel guide pipe, which maintains alignment within the center of the old pipe. Behind the lead is the cracker, which fractures the old pipe, followed by a cone expander that radially expands the fractured pipe into the soil. This is followed by the front jack which is a hydraulic cylinder that acts like an intermittent jacking station to provide the axial thrust to the leading equipment. The front jack bears against the pipe (via an adapter) that is also being jacked into the void. Lubricant is introduced at the adapter to minimize friction. The lead equipment is designed to be disassembled at a 4 feet (1.2 meters) diameter receiving manhole and removed. With the Tenbusch method, only rigid pipes that can withstand the high axial jacking loads are used for the replacement. This is mainly clay and DI pipe.

3.5.1.3 Pipe Slitting. Pipe slitting is a variation of the static method incorporating cutting wheels in advance of the bursting head. The cutting wheel slits the ductile pipe, such as DI or steel, allowing the bursting head to then open up the slit pipe. All other aspects are similar to static bursting. Pipe slitting has been carried out on pipes from 6 to 24 inches (150 to 600 mm) in diameter.

3.5.2 Offline Replacement. As the name implies, offline replacement simply involves the installation of a new pipe without regard to the line and grade of the existing pipe. Normally the existing deteriorated pipe being replaced is kept in service (at reduced operating conditions if necessary), while the new replacement pipe is being installed. Once the new pipe is in place and has been leak tightness tested, a switchover is made.

3.5.2.1 Open Cut. Historically, the most often used renewal method of a deteriorated sewer force main is open cut replacement. Force mains, like water mains, are generally not buried very deep so the cost of open cut excavation is less than for deep gravity sewer mains. However, other indirect costs such as disruption to traffic and the general public or interference with other underground structures can raise the cost of open cut replacement to a point where rehabilitation or replacement with trenchless means is more cost-effective.

3.5.2.2 Directional Drilling. Directional drilling is a trenchless excavation method. First, a small-diameter pilot hole is drilled along the designed directional path. The drill head can be steered both horizontally and vertically and is equipped with a head-location device (sonde) for shallow drilling applications. The pilot hole is then enlarged and finally the replacement pipe is pulled in to the reamed hole. Typical pipes that can be pulled into the hole are steel, HDPE, PVC, and DI. Steel pipe would either have welded joints, or mechanically-locked joints such as Permalok. Butt-welded joints are used with HDPE and either fusible joints on PVC or mechanically-locked joints such as Certalok from Certainteed or Terrabrute by IPEX. The radius of curvature commonly used for designing drill paths is 1,200 times the nominal diameter of the pipe. This is based on established practice for steel pipe. HDPE and PVC, which have greater flexibility than steel could accommodate a tighter radius if needed. Diameters that have been installed by HDD are 2 to 60 inches (50 to 1,500 mm) and lengths up to over 10,000 feet (3,049 meters). HDD has been especially useful on river crossings and for the installation of service connections. In 2005, the American Society of Civil Engineers (ASCE) released a manual of practice (MOP #108) for *Pipeline Design for Installation by Horizontal Directional Drilling* (ASCE, 2005).

3.5.2.3 Microtunneling/Pipe Jacking. Microtunneling or pipe jacking involves the installation of a new pipe behind a tunneling shield or tunnel boring machine (TBM). On short to medium length drives, the pipe string and shield are driven forward by hydraulic jacks operating from a drive shaft (on long drives, intermediate jacking stations may also be installed at intervals along the pipe string). Once the TBM reaches the reception pit, it is removed. The jacked pipes can be the replacement pipes themselves, or they can serve as a casing for subsequent installation of the replacement pipes by sliplining.

With the different types of tunneling machines available, including slurry and earth pressure balance (EPB) machines, with cutting heads to handle rock and mixed ground conditions, a wide variety of ground conditions can be handled. A Geotechnical Design Summary Report (GDSR) and a Geotechnical Baseline Report (GBR) typically are used to define the geotechnical parameters of a tunneling project so that there is a clear understanding of the geotechnical conditions expected on a project. Diameters from 6 to 120 inches (150 to 3,000 mm) can be microtunneled and curved alignments with joint deflections of up to 5% can be accommodated (although curved alignments currently are uncommon in the US).

The selection of the right jacking pipe is paramount. Typically, the loads imposed on the jacking pipe during installation are going to control the pipe design. Jacking loads of up to 1,000 tons are possible, so

the jacking pipe needs to have high axial compressive strength and stiffness. “In wall” joints are used to avoid projections beyond the OD of the shield and to minimize friction between the pipe wall and the soil. Bentonite slurry is usually introduced between the pipe barrel and the soil to minimize friction, but smooth, non-porous pipe surfaces are also beneficial. The intermediate jacking stations (IJS) used on long drives are operated in sequence so that only sections of the jacking pipe are slid through the ground at any one time. This minimizes the jacking force needed to drive the tunneling machine and pipe column forward.

Typical pipes that have been used for jacking of pressure pipes are GRP, polymer concrete, reinforced concrete, steel, and DI. PVC can also be jacked, but requires a large number of IJS, making it somewhat uneconomical.

GRP

Hobas pipe, which is a centrifugally cast glass-reinforced plastic mortar pipe, has been used on a large number of intermediate diameter (24 to 84 inches [600 to 2,100 mm]) microtunneling projects. Hobas pipe, with its tight tolerances on OD and relatively high axial compressive strength, has dominated the gravity sewer microtunneling market in Houston, TX. Although the pipe itself might be capable of carrying internal pressure, the joint used for microtunneling does not lend itself to pressure applications. A variation on ordinary GRP pressure pipe for microtunneling is produced in Germany by Hume Rohr. Hume Rohr is a manufacturer of precast concrete pipe. They purchase GRP pressure pipe from the Flowtite® producer near Dresden and then use the GRP as an inner mold casting a concrete pipe outside. The end result is a composite of concrete and GRP with the concrete handling the axial jacking loads during installation and the GRP handling the internal pressure. With GRP’s inherent corrosion resistance, this composite provides a very suitable jacking pipe for a sewer force main replacement. Unfortunately, there are no producers of this composite pipe concept in North America at the moment.

Polymer Concrete

A variation to the composite made of GRP and concrete is the polymer concrete pipe. There is a standard specification (ASTM D6783) for polymer concrete pipe. Meyerhof in Germany was one of the pioneer developers of polymer concrete pipe. Meyer’s Polycrete® is now produced by US Composite Pipe in Zachary, Louisiana. Polycrete is a composite consisting of polyester resin, sand, aggregate, and a mineral filler. Polymer concrete, which actually doesn’t use any cement, uses 9% to 10% by weight of polyester resin to bond the silicate aggregate, creating a dense, corrosion resistant matrix. The pipe is produced using a vertical casting process, similar to concrete pipe. The joint has a 316 stainless steel collar mounted integral to the pipe wall for microtunneling applications. With an average axial compressive strength of 15,000 psi (1,034 bar), the Meyer Polycrete pipe has ample strength for jacking forces. The pressure limitation of the joint is only 35 psi (2.4 bar), so the pipe’s usefulness as a replacement pipe for a sewer force main is limited.

Steel

Permalok is an interlocking pipe joining system. Permalok is produced by Permalok Corporation in St. Louis, MO and is available in diameters from 30 to 120 inches (750 to 3,000 mm). The steel pipe is manufactured by the rolled and welded cylinder method utilizing the double submerged arc welded (DSAW) process. The joint is an integral, machined press-fit connection incorporating a double “o” ring gasket, which is intended to be used for low to medium pressures (up to 300 psi [21 bar]). The joint is assembled in the field by the jacking frame. The T7 profile (Figure 3-26), which is the pressure joint, was introduced in 2002. Once assembled, the Permalok joint is flush with the exterior and interior surfaces of the pipe rendering it suitable for both pipe jacking and HDD applications. Coatings and linings suitable for a variety of applications are available from Permalok. Permalok, with the right lining, would be a candidate for replacing a sewer force main using microtunneling/pipe jacking or HDD.

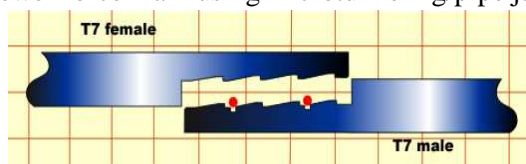

Figure 3-26. Permalok T7 Pressure Joint

4.0 TECHNOLOGY SELECTION CONSIDERATIONS

Aside from selecting renewal technologies on the basis of their fit to the force main's operating conditions (e.g., pressure, burial depth, etc.), other site-specific parameters must be considered in the selection process. The life-cycle cost of the renewal method and its impact on extending the life of the asset are often the primary concerns in technology selection. Other site-specific factors that should be taken into consideration include post-renewal capacity needs, accessibility, future O&M requirements, the condition of the host pipe, and the consequence of its failure (criticality). All of these items are explored here. As discussed in Section 5, other technology-specific factors that play a role in technology selection are corrosion resistance, long-term HDB, temperature derating, duration of by-pass pumping, use of non-standard pipe materials and dimensions, and the methods for reinstatement of fittings and connections.

4.1 Life-Cycle Costs

Renewal technology selection is guided by consideration of life-cycle costs over the remaining life of the asset or its extended life with the renewal. In principal, the concept is to break down all costs associated with an alternative (including the alternative of doing nothing) into a net present value for comparative purposes by discounting future expenditures and the remaining salvage value of the asset. Present costs would include the capital funds needed for renewal of the underground asset including engineering and construction. Each alternative may also have a different life expectancy and different future O&M costs. In surveying vendors of rehabilitation products, they were each asked to provide capital costs and some guidance on the nature of future maintenance that might be required for their technology. Without exception, all replied nothing out of the ordinary was needed for O&M. Cost data were collected to the extent possible as outlined in Appendix A. However, the availability of this data was limited. Figure 4-1 illustrates representative cost data from a collection of bid tenders from across the US on various trenchless installation methods (Simicevic and Sterling, 2003). These costs were collected in 2002 and 2003, so current costs will be higher, but the relative comparison is still valid.

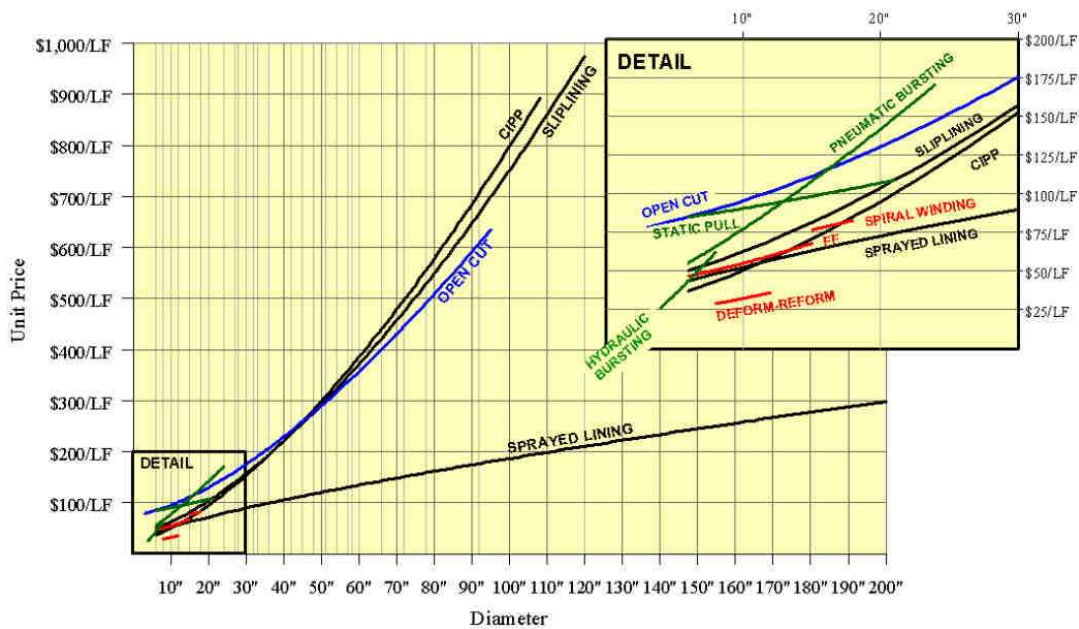

Figure 4-1. Total Installation Cost in 2003 Dollars for Trenchless Rehabilitation Methods (Simicevic and Sterling, 2003)

Capital Costs

The TTC collected bid tenders from all over the US on various trenchless installation methods and published a report in 2003 highlighting the results. The report compared installation costs for open cut replacement for pipes and manholes with pipe rehabilitation or replacement including CIPP, sliplining, fold-and-form, deformed and reformed, spray-on linings, pipe bursting, HDD, microtunneling, pipe jacking, localized pipe and joint repairs and manhole rehabilitation including cementitious and polymer spray coatings, preformed manhole inserts, and manhole liners. Although the cost data are from 2003, it is still one of the best documented reports on installed costs of trenchless technologies.

The Office of Water Service (OFWAT), which is the UK Water Services Regulation Authority, has also collected information from the UK water industry on rehabilitation costs for water mains (OFWAT, 2005). This includes close-fit liners, polymer spray-on linings, sliplining, HDD, and pipe bursting. OFWAT surveyed 13 water utilities and obtained installed cost data on these various rehabilitation methods. A benchmark cost was then determined based on the mean value. The open cut replacement data were further broken down into rural, suburban, and urban segments. Figure 4-2 is a summary chart comparing the cost of four rehabilitation options to open cut replacement. “Insert” is a close-fit polyethylene liner. The data do show the favorable cost impact of carrying out epoxy lining and insertion of a close-fit PE liner versus open cut replacement. When compared to an urban environment, all of the rehabilitation methods are more cost-effective than the open cut replacement option.

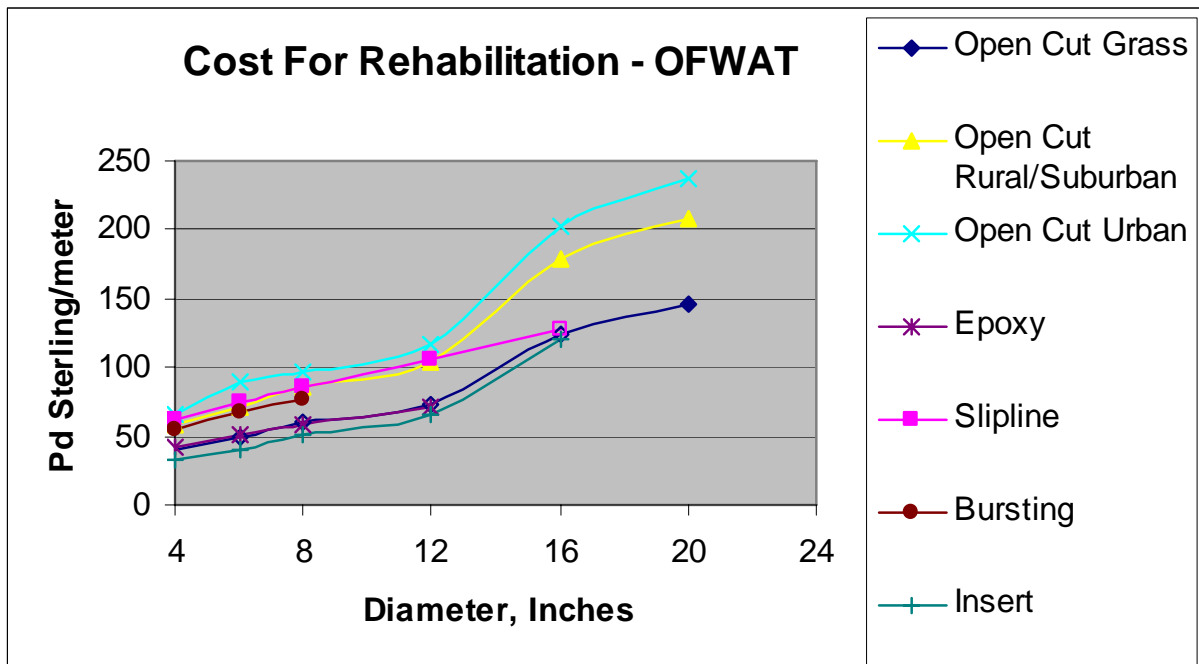

Figure 4-2. UK Water Rehabilitation Costs (OFWAT, 2005)

O&M Costs

One potential difference in operational cost would be pumped energy requirements. Reduced diameters, associated with sliplining and liners, means higher velocities to maintain the same flow quantities. Higher velocities translate into higher head loss (proportional to the square of the velocity). This can be offset to some degree by a lower friction factor, which many of these new polymer products possess. The bottom line is energy requirements for pumping operations may be increased to overcome the additional

head loss to maintain flow capacity. This cost needs to be factored into the decision process when considering alternatives.

Future expenditures could include the cost of repairing a major break in a main, or carrying out some renewal on the main in future years. These costs, especially the timing and cost of a break, can be difficult to quantify, but some estimate is needed for a life-cycle cost comparison.

All else being equal, the renewal alternative with the lowest present value based on a life-cycle cost analysis would be the selected option. However, there are usually other considerations that must also come into play and have a bearing on the choice of renewal technologies as discussed below.

4.2 Capacity

Some consideration must be given to the capacity requirements of a system whenever a sewer force main asset reaches its end-of-life and a decision is to be made on either renewing or replacing the asset. This often requires hydraulic modelling of the wastewater system in combination with population density forecasts. This model will help to determine if the existing force main is of adequate size, whether it could be downsized to allow for certain renewal technologies, or if upsizing is needed to handle predicted future flows from growth.

Sliplining of a sewer force main is going to result in a loss of cross-sectional area and therefore capacity. With a 5% reduction in inside diameter, which is essentially the minimum that could be sliplined, the corresponding loss of capacity with no change in friction factor is 10%. A 10% inside diameter reduction, which is more normal, will result in a 19% loss of capacity. Unless that type of capacity loss can be tolerated, or cost-effectively accommodated with pump upgrades, sliplining is going to fall by the wayside as an effective option. A pump upgrade to maintain or improve capacity is an expensive option, but still merits consideration.

Most of the PVC and PE close-fit liners and CIPP lining products will result in a very modest 0.5% to 3% reduction in inside diameter of the pipe. The improved flow characteristics of these smooth liners, usually with Hazen & Williams flow coefficients of 145 or higher, compensate for the slight reduction in cross-sectional area. These solutions will generally work when the present system offers sufficient capacity.

If future growth dictates that greater capacity will be required, then the options for rehabilitation narrow to either offline replacement with a new, larger diameter pipe or pipe bursting with upsizing. The diameter limit on upsizing is generally limited to one or maximum two pipe diameter sizes. Larger upsizings have been successfully completed, but should be carefully evaluated as to the equipment capabilities and the effect on nearby structures.

4.3 Accessibility

Accessibility will affect both the cost to renew a sewer force main, as well as the chosen technologies. Fully deteriorated pipelines in rural areas, with no environmentally sensitive areas to cross, and not likely to inconvenience the general public, will be more cost-effective to fully replace using conventional open cut construction as opposed to the use of a structural lining in the existing pipe. That comparison may change in the future as new structural spray-on linings become available.

Conversely, pipelines in congested areas with traffic and underground utilities to contend with, either partially or fully deteriorated, are ideal candidates for some form of either online replacement or rehabilitation. Pipe bursting needs to be carefully controlled if the main is in close proximity to other

utilities or foundations. For partially deteriorated mains, close-fit liners can be extremely cost-effective for rehabilitating a main especially in congested, built up areas. The City of New York had a deteriorating 150 year old 48 inch (1,200 mm) CI water main running down Madison Avenue. Insituform Blue was able to install 10,000 feet (3,049 meters) of its new interactive HDPE liner (PolyFlex DR 50) in several stages with minimal disruption to traffic and business.

Some pipelines even get “misplaced” and end up with structures built directly over them. Jason Consultants recently had a project where a 48 inch (1,200 mm) PCCP water main was found to be in significant distress. Eight manufactured homes were located directly on top of this main. In this case, rehabilitation was the only viable cost-effective solution. The pipeline was sliplined with steel pipe of a smaller diameter and the annular space was grouted.

4.4 Maintenance

One of the issues continually raised by O&M personnel is the question of repairing a break in a sewer force main that has been rehabilitated or sliplined. Utilities usually keep on-hand repair clamps, replacement pipe sections and special adapter fittings so an emergency repair can be made on a main that bursts at an inconvenient time. Crews are trained to work with those pipe materials that are predominantly used by the utility and are knowledgeable about how to repair a burst or leaking joint in such materials. The methodology for repairing a break in a ferrous main that has been lined with a close-fit PE liner or a CIPP liner is not generally known. As such, O&M personnel are reluctant to accept rehabilitation options over offline replacement with known materials. The industry has to do a better job of developing training tools and repair kits to alleviate this concern. Otherwise, cost-effective rehabilitation schemes are being overlooked in favor of replacement.

4.5 Condition Assessment and Asset Criticality

Condition assessment plays a major role in asset management decisions and provides indirect and direct data on the host pipe condition to assist in decision-making between repair, rehabilitation, and replacement technologies. Improvements in condition assessment practices may lead to a better understanding of the host pipe condition and therefore increased confidence in the use of semi- or fully-structural rehabilitation technologies.

Due to the difficulties associated with inspecting force mains, especially those that cannot easily be taken out of service for more than a few minutes, little if any inspection is carried out by most utilities. WERF, in recognizing this growing need for condition assessment, funded a research project to develop guidelines for inspecting sewer force mains. Originally, the target of the research was on ferrous mains, which represents over 58% of the force main population, but later it was expanded to cover all possible force main materials. The recently published report is titled *Guidelines for the Inspection of Force Mains* (WERF, 2009) and can be reviewed for detailed information on the SOT for force main inspection and condition assessment.

Risk-based investigation (RBI) involves consideration of both the likelihood of failure and the consequence of a failure for a given pipe system. Criticality is often expressed as the product of these two factors. Assets with a high consequence of failure may warrant further investigation by gathering both indirect and direct data on the host pipe condition. Indirect data can include factors such as the age of a pipeline, whether the pipeline has any external corrosion protection or is installed in an environment considered corrosive, history of previous failures in the main, presence of inoperative air release valves, operating conditions (pressure, surge, burial depth) versus the pipe’s original design rating, and more. External or internal inspection can also yield direct data on the pipe condition. Inspections might include either small portions or the entire pipeline being surveyed for signs of deterioration. In the case of a

ferrous main, this can be an internal or external inspection using electromagnetic or ultrasonic tools to measure the remaining wall thickness. For PCCP, it might include acoustic monitoring to locate active wire breaks. If the PCCP main can be taken out of service, then an internal electromagnetic survey is possible where cumulative wire breaks are detected. Many other tools are available for inspecting a sewer force main (WERF, 2009).

The results of the indirect and direct investigation can then be fed into a mechanistic model to determine the likelihood of failure. Figure 4-3 is an example of a belief chart for assessing the risk of a structural failure in PCCP pipe based on indirect evidence. This type of model is pipe material specific with predictions made of the remaining factor of safety or remaining life of the pipeline. The other aspect to carrying out a risk assessment and criticality ranking is to evaluate and quantify the consequences of a failure in a pipeline. Figure 4-4 illustrates a belief network for a PCCP pipe to estimate the consequence of failure, but would be equally valid for any pipe material.

Often the consequences of a failure can be put in terms of costs. For example, it might be based on the direct cost to repair a broken pipe and provide temporary service during the repair if needed, the cost to clean up local flooding or repair adjoining property damaged as a result of a major rupture, and/or indirect costs associated with the socio-economic impact of a failure. The socio-economic costs can often exceed the cost expended in the immediate repair of the broken main. This is especially true for sewer force mains where raw sewerage can cause damage to the environment and adjacent property resulting in significant clean-up costs.

Sewer force mains that convey a major portion of a municipality's sewage, with no backup or redundancy, would have a high consequence of failure rating. Here, local knowledge of the system is extremely important in making these determinations. From the standpoint of what action may be warranted, certainly pipelines that have a high likelihood for failure combined with significant consequences associated with such a failure (e.g., a high criticality rating) deserve urgent attention. Plus, the higher the consequences associated with a failure, the more conservative will be the approach towards renewal of the main. A partially deteriorated force main that has an extremely high consequence of failure would be one that would probably be treated as fully deteriorated from the perspective of the design of the rehabilitation system.

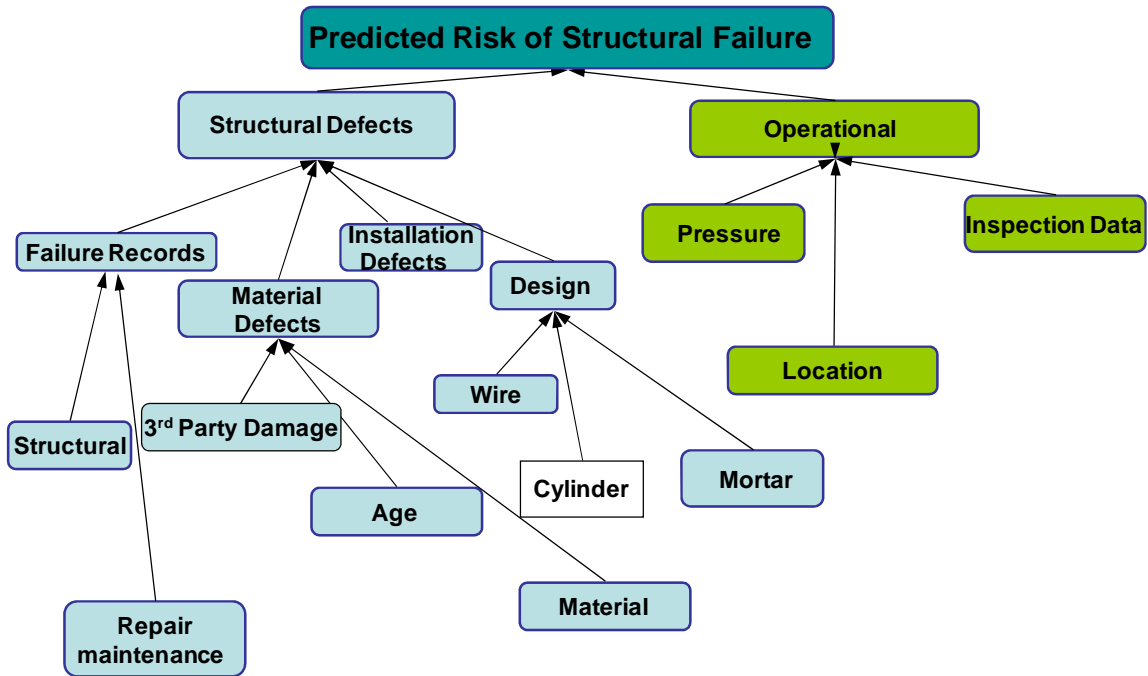

Figure 4-3. Belief Network for Risk of Failure in PCCP

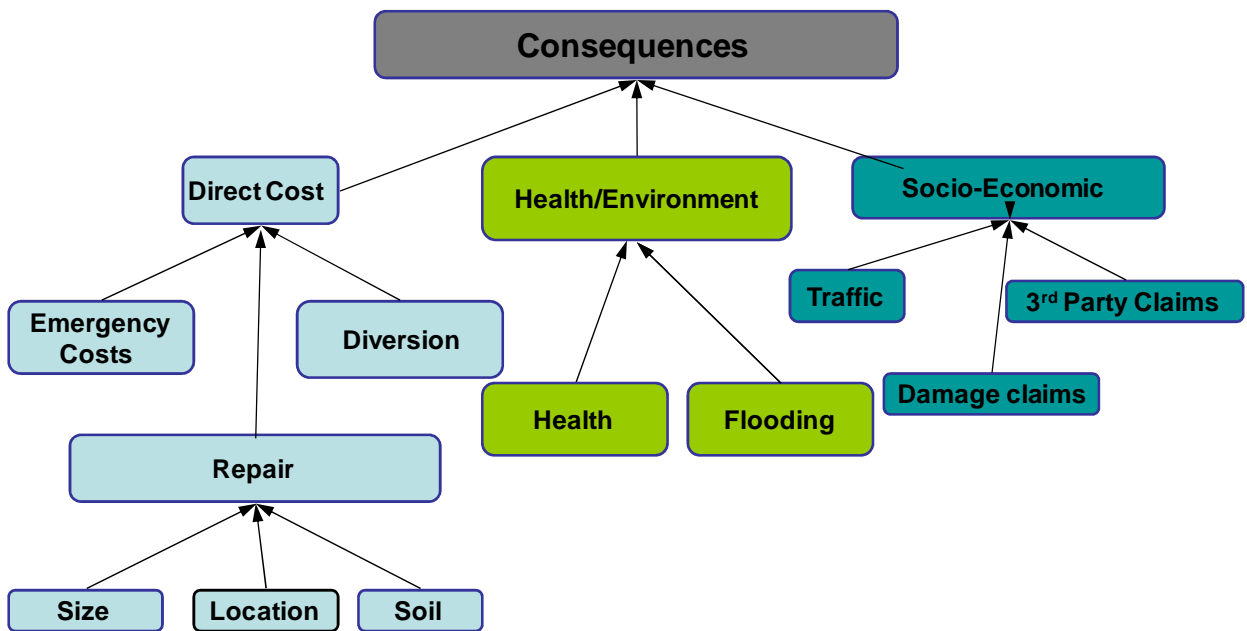

Figure 4-4. Belief Network for Consequences of Failure in PCCP

5.0 DESIGN AND QA/QC

This section will review the existing design concepts that pertain to the renewal of a force main. The design methods currently employed are for either interactive or independent liners and depend upon the condition of the existing (host) pipe. A complete review of most applicable ASTM standards is included. These standards are broken down by material type and functionality including product/material, design, and installation practices. The section also covers the QA/QC aspects of renewal by looking at short-term factory and field requirements, as well as long-term qualification requirements. The latter are notably lacking for many products offered for both a pressurized and corrosive environment.

5.1 System Design

5.1.1 Redundancy in System Design. Force mains are often located at critical points in a utility's sewerage system. They typically carry a large percentage of a utility's untreated wastewater and in a few cases all of the flow to the wastewater treatment plant is conveyed through force mains. Despite the critical nature of sewer force mains, less than 5% have any redundancy built into the system (WERF, 2009). The use of redundancy in system design appears to be a more frequent practice in Europe than the US. If a line is taken out of service due to a failure, by-pass pumping or the use of honey trucks is necessary. Those that do have a redundant line can use it during a failure to maintain a minimal level of flow, avoiding overflowing wetwells, and surcharging upstream sewers. The other advantage to having a redundant line is the ability to take a force main out of service for an extended period of time to allow for either an intrusive (internal) inspection or for extended repairs or rehabilitation.

With redundancy very limited, most utilities have not been in a position to carry out in-depth inspections and assessments of their force main systems. Consequently, many utilities in the past have merely reacted to problems, such as failures, when they occur rather than being proactive in attempting to assess the force main's in situ condition. Little is known about the condition of sewer force mains in US utilities, but that is gradually changing, primarily as a result of EPA consent decrees requiring municipalities to carry out condition assessment of their force mains.

Heretofore, there has been very little rehabilitation of sewer force mains due to lack of redundancy and the availability of reconstruction products for pressure sewers. The redundancy issue isn't going to change overnight, although more utilities are considering investing in redundancy with new projects. Any attempt to rehabilitate a sewer force main, aside from outright replacement while the main remains in service, is going to either require by-pass pumping or a renovation technology that can be installed very quickly during a limited outage. The latter doesn't exist at the moment so by-pass pumping is the norm. As a result of vendor success in the gravity field with CIPP and reformable thermoplastic pipe products, adaptations of these products are now starting to find their way into the pressure sewer field.

5.1.2 Pig Launchers/Retrieval for Cleaning and Inspection. Like redundancy, pig launchers and retrieval systems are not commonly designed into sewer force mains. Some utilities, like St. Petersburg, FL, have installed pig launchers and retrievals on most of their sewer force mains and use them on a regularly scheduled basis to clean each main. Keeping the mains clean maintains capacity and reduces pumping (energy) requirements.

It is only within the past few years that some leak detection tools have become available to allow for limited assessment of a force main with little interruption in service. These tools can be introduced into the flow stream and are either tethered (Sahara[®]) or free swimming (SmartBall[®]) and will locate leaks and gas pockets in a force main. These tools can be launched through 2 inches (50 mm) (Sahara[®]) or 4 inches

(100 mm) taps (SmartBall[®]) in a force main and do not require sophisticated launchers and retrievers. The minimum pipe diameters for these leak locators are 12 inches (300 mm).

Researchers are also working on perfecting smart pigs that can be used in a live force main. The oil and gas industry have relied upon intelligent pigs for many years to assess the condition of their transmission mains. These smart pigs utilize ultrasonic or electromagnetic technology to measure the remaining wall thickness and find pitting or areas of graphitization in a ferrous pipe. Adaptations for use in a force main include the use of gas or liquid coupling for ultrasonic transducers. Pigs based on magnetic flux leakage (MFL) are heavy, but newer pigs based on remote field (See Snake) and eddy current (broadband electromagnetic [BEM]) technology are finding use in the water and wastewater industry. The See Snake can be used in a live force main, while the BEM has a limitation on the pressure head.

Acoustic emission monitoring of PCCP to locate active wire breaks is a technology that is now well employed. Acoustic monitoring does not require launchers or retrievers. Early technology deployed a string of hydrophones into the flow stream, but that has largely been replaced with the use of externally mounted accelerometers. The accelerometers are mounted directly on an air release valve or the mortar coating of the PCCP.

5.2 Renewal Design

The design of a rehabilitation product to renew the life of a distressed sewer force main range from just an inner corrosion barrier or entail outright structural replacement. Obviously, the factors that will control the design are the condition of the existing main, including its expected remaining life if further deterioration is arrested, and the operating conditions under which that main is used. Mains that are currently operating at full capacity, or are expected to be so in the near term, are not good candidates for placing a thick liner or sliplining with a smaller diameter pipe, as these will further reduce capacity. Certainly, some of the newer liners and sliplining pipes have very favorable flow characteristics (i.e., low friction factors), but that is not always sufficient to make up for the reduced cross-sectional area available to the flow. If a loss of capacity cannot be tolerated, then the most viable renewal strategy is going to be replacement.

5.2.1 Degrees of Deterioration. Assuming that some minor loss of flow capacity is acceptable, then the first thing a designer has to consider is the condition of the force main. The ASTM standards of practice for reconstruction products have categorized the condition of existing pipes into either partially deteriorated or fully deteriorated conditions. These conditions are defined as follows (adapted from ASTM F1216):

- *Partially deteriorated* – Existing pipe can support the soil and surcharge loads throughout the design life of the rehabilitated pipe. The pipe may have longitudinal cracks and up to 10% distortion of the diameter.
- *Fully deteriorated* – Existing pipe is not structurally sound and cannot support soil and live loads or is expected to reach this condition over the design life of the rehabilitated pipe. This condition is evident when sections of the pipe are missing, the pipe has lost its original shape, or the pipe has corroded.

What is apparent from these definitions is they are more relevant to gravity sewers than to pressurized mains. There is no consideration given to the existing pipe's ability to safely carry the internal working pressure or surge pressure. If a ferrous pipe has lost 40% of its wall thickness and is still handling the internal working pressure with reasonable factors of safety on hoop tensile stress, is this a partially deteriorated or fully deteriorated pipe? Or, what about a ferrous pipe that has lost 80% of its wall

thickness? It can still support the overburden soil and live loads, yet does not have an acceptable factor of safety on pressure. According to the ASTM F1216 definition, this is a partially deteriorated pipe, while most engineers might claim fully deteriorated based on its pressure capability.

The ASTM standards for new products coming into the market place designed to reconstruct pressurized mains need to be modified to reflect a better understanding on what constitutes the various degrees of deterioration that a pressurized main can undergo without failure. This will be important for sewer force main renewal, as well as water main renewal.

5.2.2 Interactive vs. Independent. Liners for sewer force main renewal fall into two categories: interactive or independent. Interactive liners are generally thin liners, in direct contact with the inside wall of the existing pipe, and which have a much lower ring tensile stiffness than the existing pipe. When pressurized, the existing pipe with the higher hoop stiffness will carry a proportionately higher percentage of the tensile ring load. Consequently, interactive liners should not be used in sewer force mains where the existing pipe has deteriorated to a point where it is not expected to be able to carry the full internal pressure over the renewal design life. Examples of this might be a ferrous main that has suffered extensive external corrosion with no protection, and has through-hole pitting over a significant portion of the system. Placing a liner on the interior will arrest any internal corrosion and can be designed to bridge over small holes and gaps, but will do nothing to stop any further external corrosion, which will eventually lead to failure. In this case, the independent liner would be preferred.

An independent liner is one that is designed to carry the full internal working pressure and surge pressure itself independent of any contribution from the host pipe. Slipliners are, by design, independent liners as they are not in direct contact with the existing pipe (unless grouted in place) and will expand circumferentially under pressure, but not transfer hoop load to the existing pipe. Some liner products start off as interactive, as they will be close-fit, but have sufficient inherent strength to carry the full internal pressure should the host pipe fail. These would then be considered independent liners.

The AWWA M28 Manual *Rehabilitation of Water Mains* has established four classes of design for rehabilitation, ranging from non-structural to fully structural (AWWA, 2001). These definitions or classes are more relevant to the design of sewer force mains than those found in the current ASTM standards. The four classes are described below:

Non-Structural

- Class I – provides no structural support, only acts as an internal corrosion barrier and improves water quality.

Semi-Structural

- Class II – resists external hydrostatic pressure from groundwater, bridges over holes and gaps in the host pipe, but not able to carry the full internal pressure independently, adheres to the interior surface of the host pipe.
- Class III – same as II except not dependent on adherence to the host pipe wall.

Full Structural

- Class IV – independently capable of resisting external hydrostatic pressure from groundwater, and can handle the full internal pressure without support from the host pipe.

5.2.3 Design Loads. Depending on the state of deterioration of the existing main, the renewal liner can be designed to be either a corrosion barrier or an outright pipe replacement. Some of the loads that must be considered depend on the state of distress in the existing pipe, and include:

External Loads

- Soil Cover (trench or embankment)
- Surcharge
- Live Load (e.g., HS-20 wheel load – dual wheel load of 16,000 lb uniformly distributed over a surface area of 10 inches x 20 inches (250 mm x 500 mm) as recommended by the American Association of State Highway and Transportation Officials [AASHTO] and Cooper E-80 rail load – axle load of 80,000 lb on 5 feet (1.5 meters) centers as recommended by the American Railway Engineering Association [AREA])
- External hydrostatic head from groundwater (only a factor when the main is not under internal pressure)

Internal Loads

- Working Pressure
- Surge Pressure
- Test Pressure

Other factors that also enter into the design are corrosion, temperature, fatigue and erosion/abrasion considerations. High points in a sewer force main are potential pockets for gas accumulation, especially if air release valves are inoperative. These tend to be areas where microbiological corrosion, due to the bacterial formation of sulfuric acid (H_2SO_4), takes place. Any new liner must be resistant to these effects.

The pressure rating of most thermoplastics and reinforced thermosetting resin pipes are based on long-term pressure regression testing at ambient temperature. Similar testing at higher temperature has shown that derating of the pressure class is necessary. The AWWA standards for PVC and PE pressure pipes contain derating tables for continuous operations at elevated temperatures of about 73.8°F. In the case of glass-reinforced thermosetting pipe, one needs to contact each individual manufacturer for their derating recommendations. One would expect that the thermoplastic and thermosetting resin liners offered for rehabilitation would be no different than their pipe cousins.

Due to the presence of solids, force mains are far more abrasive environments than potable water mains. It has been reported that some force mains with concrete liners (PCCP and asbestos-cement) have had a channel eroded down the invert (King County, Tel Aviv, Israel). At low velocities of approximately 1.5 feet (0.46 meters) per second or less, large solids tend to tumble along the invert of the pipe until they are broken up into smaller particles that can be suspended in the waste stream. The erosion appears more prevalent at the beginning of the force main and gradually tapers off over a long run. There has also been a report on a steel force main with a bitumastic liner that has lost nearly all of the liner and up to 70% of the pipe wall in the bottom one-third of the pipe from the abrasive effects of the effluent (Regina, SK in Canada). Therefore, the design of a renewal liner for a sewer force main must take the potential for erosion into consideration. Fortunately, the newer materials used for lining sewers generally have good abrasion resistance. Polyethylene has been shown to have excellent abrasion resistance in tests conducted at Darnstad University in Germany.

It has been documented that the long-term performance of PVC can be limited by its fatigue resistance to cyclic pressure loading. This first surfaced on irrigation distribution systems where the buried PVC distribution piping was subjected to very frequent cyclic loading from valve operations. Pumped sewer force mains are similar as lift station pump(s) are constantly cycling in and out as the sewage level in the wetwell triggers the starting and stopping of the pumps. The Unibell PVC Pipe Association has published a design guideline for the use of PVC pipe in sewer force mains. This guideline provides recommendations on maximum pressure ratings based on the number of pressure cycles expected in the

pipe's design life. Once again, it would be reasonable to expect that any renewal liner using PVC material would be affected similarly by cyclic loading and should be designed accordingly.

5.2.4 Other Considerations. Force mains do not have frequent service connections as in a water main, but nonetheless there are usually pressurized connections to other incoming or outgoing mains, air release valves at high points, and other inline fittings (valves, elbows, etc.). The protocol with practically all force main rehabilitation systems, except independent slipliners, is to terminate the liner with a special mechanical fitting that seals the end of the liner with the existing host pipe, and then incorporate a ductile or CI fitting for the connection to the fitting or valve. Slipliners, such as full thickness PE and PVC pipes, can be re-connected in the same manner as ordinary pipe made of these same materials. Electrofused fittings for PE and DI fittings for PVC are common.

Another important design consideration in a renewal project is the intended design life of the rehabilitated system. The renewal can be a fully structural replacement for the existing pipe, in which case a design life of 50 years is desired. Or, the renewal may only be a corrosion barrier (Class I) or a close-fit semi-structural liner (Class II or III) with a design life dependent on the continued structural performance of the existing pipe. If the existing pipe is incapable of handling the internal pressure due to external corrosion, then the design life of the renewal liner is going to be limited to that of the existing pipe. As reported in a recent report (WERF, 2009), the majority of sewer force mains are under 25 years of age with few over 50 years, which is quite different from the age distribution of the nation's water distribution system. Consequently, it is reasonable to expect that any renewal liner should be able to extend the design life of a sewer force main for at least another 25 years.

5.3 Product/Material Standards

The two main national organizations within the US that undertake development of consensus standards covering materials, products, testing methods and installation methodologies are ASTM and the AWWA. These bodies provide a forum for producers, users, and those having a general interest (e.g., government, academia) to write standards that best meet their needs. Representatives from each interested field are involved in the standards process, but the producer community normally takes a leading role. AWWA standards are solely dedicated to the water industry. Some products or linings that are used in the water industry may also have a place on the wastewater side. Epoxy linings are a good example of dual potential use. The National Association of Sewer Service Companies (NASSCO) has also developed some excellent guideline specifications and manuals of practice. Producer companies are solely involved in the NASSCO specifications so the user community's interests may not be fully appreciated.

The body of standards can be broken down into four areas – product/material standards, design standards, and installation standards, and manual of practices. Some of the standards serve more than one purpose. The purpose of this report is not to provide a detailed review of each pertinent standard, but rather to highlight some of the more important standards and especially those that are relatively new within the past 5 years and may have a use for sewer force main renewal.

ASTM Product/Material Standards

This section summarizes product/material standards by pipe type including those defined for PVC, PE, CIPP, and FRP/GRP materials.

PVC Materials

The following ASTM standards in Table 5-1 cover PVC materials used for renewal.

Table 5-1. ASTM Material Standards for PVC Pipe

Specification No.	Title	Application
ASTM F1504	<i>Standard Specification for Folded Polyvinyl Chloride (PVC) Pipe for Existing Sewer and Conduit Rehabilitation</i>	4-15 inch folded PVC for non-pressure sewers
ASTM F1871	<i>Standard Specification for Folded/Formed Polyvinyl Chloride Pipe Type A for Existing Sewer and Conduit Rehabilitation</i>	4-18 inch folded PVC for non-pressure sewers
ASTM D2241	<i>Standard Specification for Polyvinyl Chloride (PVC) Pressure-Rated Pipe (SDR Series)</i>	Pressure rated PVC pipe

ASTM F1504

This product standard is nearly identical to ASTM F1871, except that the minimum flexural modulus is 280,000 psi (19,310 bar) (PS-1, cell 13223-B). With the higher flexural modulus, pipe stiffness values are also higher for the same DR ratio. Pipe stiffness (a measure of the flexural stiffness of the pipe ring in resisting vertical load) ranges from 10 psi (0.7 bar) for DR 50 (PS-1) to 41 psi (2.8 bar) for DR 35 (PS-3). Diameters covered range from 4 to 15 inches (100 to 375 mm), with starting DR range of 35 to 50. The final DR will depend on the amount of expansion (or contraction) induced in the PVC liner as it conforms to the host pipe. Typical QC test requirements include diameter and thickness dimensional checks, pipe flattening, impact resistance, pipe stiffness, flexural properties and acetone immersion, and heat reversion for extrusion quality.

ASTM F1871

Diameters covered range from 4 to 18 inches (100 to 450 mm), with a DR range of 26 to 41. Pipe stiffness (which is dependent on the flexural modulus and DR ratio) ranges from a high of 41 psi (2.8 bar) for DR 26 to 11 psi (0.76 bar) for DR 41. The “A” in Type A is an arbitrary designation of PVC compounds with a minimum modulus of tension of 155,000 psi (10,670 bar) and a maximum of 280,000 psi (19,310 bar). The minimum tensile strength is 3,600 psi (248 bar) and flexural modulus 145,000 psi (10,000 bar). Although this specification states the application is for non-pressure sewers, pipe meeting this specification could be used in a low pressure sewer force main.

ASTM D2241

This standard covers PVC pipe made in standard thermoplastic pipe DRs and pressure rated for water. PVC pipes meeting this specification would be suitable for inline replacement of an existing sewer force main by the sliplining method.

Polyethylene Materials

The following ASTM standards in Table 5-2 cover PE materials used for renewal.

Table 5-2. ASTM Material Standards for PE Pipes

Specification No.	Title	Application
ASTM F1533	<i>Standard Specification for Deformed Polyethylene (PE) Liner</i>	3-18 inch deformed PE liner for non-pressure
ASTM D2239	<i>Standard Specification for Polyethylene (PE) Plastic Pipe (SIDR-PR) Based on Controlled Inside Diameter</i>	Pressure rated PE pipe based on ID
ASTM D3035	<i>Standard Specification for Polyethylene (PE) Plastic Pipe (DR-PR) Based on Controlled Outside Diameter</i>	Pressure rated PE pipe based on OD

ASTM F1533

The renewal process involves installing a deformed PE liner into an existing pipeline and then reforming the liner with heat and pressure to fit tightly to the bore of the original pipeline. PE pipe used for a liner under this specification shall be PE 2406 or PE 3408 (ASTM D3350), with a Plastic Pipe Institute (PPI) recommended HDB of 1,250 or 1,600 psi (86 or 110 bar), respectively. Nominal pipe diameters range from 3 to 18 inches (75 to 450 mm), with a DR range of 17 to 32.5. Other non-standard sizes are also covered providing the materials meet the minimum requirements in this standard. Typical QC test requirements include outside diameter and wall thickness checks, tensile strength, tensile elongation, and flexural modulus. Environmental stress crack resistance (ESCR) is a qualification test, with level 3 of ASTM D3350 as a minimum.

ASTM D2239 or ASTM D3035

Pipe meeting these standards would be suitable for inline replacement of a sewer force main by the sliplining method, providing the reduction in flow capacity can be accommodated.

CIPP Materials

The following ASTM standards in Table 5-3 cover CIPP materials used for renewal.

Table 5-3. ASTM Material Standards for CIPP

Specification No.	Title	Application
ASTM D5813	<i>Standard Specification for Cured-In-Place Thermosetting Resin Sewer Pipe</i>	4-132 inch CIPP used in gravity systems

ASTM D5813

Three types and two grades of CIPP liners are described in this standard. The type of liners range from those designed to only provide chemical resistance and prevent exfiltration (Class I) to those designed for use in either a partially deteriorated (Class II) or a fully deteriorated pipe (Class III). The grades are distinguished by whether the tube is impregnated with polyester resin (Grade 1) or an epoxy resin (Grade 2). ASTM D5813 also has two chemical resistance requirements. The one requirement stipulates that samples shall be capable of exposure for one year to five different chemical solutions (1% nitric acid, 5% sulfuric acid, 100% ASTM Fuel C, 100% vegetable oil, 0.1% detergent, and 0.1% soap) and still retain 80% of their flexural modulus. The other requirement is similar to that imposed on glass-reinforced thermosetting plastic pipes (ASTM D3262 or ASTM D3754) and is commonly referred to as strain corrosion. For this requirement, samples must be capable of being deflected to meet certain strain requirements (see Table 2 of D5813) over specific time periods of up to 10,000 hours, while exposed to 1.0 N sulfuric acid (i.e., 5%).

Glass-Reinforced Plastic

The following ASTM standard in Table 5-4 covers FRP/GRP materials used for renewal. ASTM D3754 combines the pressure requirements of ASTM D3517 Fiberglass Pressure Pipe with the chemical resistance (strain corrosion) requirements of ASTM D3262 Fiberglass Sewer Pipe.

Table 5-4. ASTM Standards for FRP/GRP

Specification No.	Title	Application
ASTM D3754	<i>Standard Specification for Fiberglass ... Sewer and Industrial Pressure Pipe</i>	8-144 inch GRP pressure pipe for force mains, pressures up to 250 psi

5.4 Design Standards

This section reviews design standards for PVC (Table 5-5), PE (Table 5-6), FRP/GRP (Table 5-7), and CIPP (Table 5-8) systems.

Table 5-5. Design Standards for PVC Materials

Specification No.	Title	Application
ASTM F1867	<i>Standard Practice for Installation of Folded/Formed Polyvinyl Chloride (PVC) Pipe Type A for Existing Sewer and Conduit Rehabilitation</i>	Design appendix same as F1216.
ASTM F1947	<i>Standard Practice for Installation of Folded Polyvinyl Chloride (PVC) Pipe into Existing Sewers and Conduits</i>	Design appendix same as F1216 for gravity.
AWWA M23	<i>PVC Pipe – Design and Installation</i>	Working pressure rating; buried pressure pipe design

ASTM F1867

This standard contains a non-mandatory design appendix for the use of formed PVC in either a partially deteriorated or fully deteriorated pipe. The design method is the same as in ASTM F1216 for CIPP products. In the case of a partially deteriorated pipe, where the existing pipe is expected to carry any soil or live load, the formed pipe is designed to resist buckling from external hydrostatic pressure due to groundwater or internal vacuum. In the case of fully deteriorated pipe, the formed PVC is designed to resist buckling from soil, live load, and any external hydrostatic pressure.

ASTM F1947

This standard describes the rehabilitation procedures of sewer liner by the insertion of a folded PVC pipe and has a design appendix (non-mandatory) that is the same as Appendix X1 in ASTM F1216 for gravity pipe. No design equations are offered for pressure applications.

AWWA M23

The AWWA manual on PVC pipe design provides information on the general properties of PVC materials and manufacturing methods. The long-term pressure capacity of PVC pipe is defined, along with recommended factors of safety. The design of PVC pipe for external loads is primarily focused on limiting vertical deflection. Longitudinal bending, which might be important for HDD applications, is also covered by this manual.

Table 5-6. Design Standards for Polyethylene Materials

Specification No.	Title	Application
ASTM F1606	<i>Standard Practice for Rehabilitation of Existing Sewers and Conduits with Deformed Polyethylene (PE) Liner</i>	Includes a design appendix for non-pressure applications.

AWWA M55	<i>PE Pipe – Design and Installation</i>	Working pressure ratings; buried pipe pressure design, sliplining guidelines
----------	--	--

ASTM F1606

This standard also contains a non-mandatory design appendix. As the practice is only intended to cover gravity installations, the liner is designed to resist buckling from hydrostatic groundwater pressure in the case of a partially deteriorated host pipe or hydraulic, soil, and live load in the case of a fully deteriorated host pipe. Unlike the standard practices for deformed PVC pipe, the design formula for the partially deteriorated condition does not include an “enhancement factor” (K) to reflect the confinement contribution of the host pipe to the liner’s buckling resistance. However, there is a note included that does introduce the enhancement factor to the modified Timoshenko formula.

AWWA M55

The AWWA manual on PE pipe design is very comprehensive, similar to the PVC pipe manual. Perhaps the most important section in the manual deals with the determination of the working pressure rating of PE based on the hydrostatic design basis. Surge calculations and allowance are also covered by the manual. The manual also provides guidance on the installation of PE pipe taking into consideration its thermal specific weight properties, which can be important in a sliplining application.

Table 5-7. Design Standards for Glass-Reinforced Thermosetting Plastic Pipe

Specification No.	Title	Application
AWWA M45	<i>Fiberglass Pipe – Pressure Pipe Design</i>	Most comprehensive design approach, covers direct buried FRP/GRP pipe

AWWA M45

AWWA M45 offers a comprehensive design method for the use of glass-reinforced plastic (i.e., Fiberglass) pipe in a pressurized system. The design is suited for buried pipe and takes account of the interaction of external loads and internal pressure on FRP/GRP pipe’s long-term performance. Calculations include pipe deflection to limit bending strain and buckling. Many of the design principles can be used for a sliplining application, especially if the FRP/GRP pipe is to be a fully structural solution.

Table 5-8. ASTM Design Standards for CIPP Materials

Specification No.	Title	Application
ASTM F1216	<i>Standard Practice for Rehabilitation of Existing Pipelines and Conduits by the Inversion and Curing of a Resin-Impregnated Tube</i>	Appendix X1 most frequently used for renewal products. Covers pressure.
ASTM F1743	<i>Standard Practice for Rehabilitation of Existing Pipelines and Conduits by Pulled-in-Place Installation of Cured-in-Place Thermosetting Resin Pipe (CIPP)</i>	Refers to F1216, Appendix X1 for design
ASTM F2019	<i>Standard Practice for Rehabilitation of Existing Pipelines and Conduits by the Pulled in Place Installation of Glass Reinforced Plastic (GRP) Cured-in-Place Thermosetting Resin Pipe (CIPP)</i>	Refers to F1216, Appendix X1 for design

It was reported at the EPA-sponsored International Forum on Rehabilitation in Edison, NJ in September 2008 that a new hydrostatic buckling model, with imperfections quantified, is being prepared for ASTM F1216. ASTM F1216 is described below.

5.4.1 Design of Pressure Systems. As outlined above, deteriorated pipelines are classified as either partially or fully deteriorated based on their ability to continue to resist internal pressure and external load. A partially deteriorated pressure pipe would have some evidence of pinhole leaks or leaking joints, but would be capable of withstanding the internal operating pressure and any external loads (soil, live, and hydrostatic groundwater). In this case, the renewal liner is designed to be a close-fit to the existing pipe and the hoop tensile stresses are carried by the host pipe. However, the liner is designed to support any external hydrostatic pressure (only a factor when the line is not under pressure) and to be able to span over any holes or gaps in the host pipe.

A fully deteriorated pressure pipe is one with large holes or gaps (most probably caused by severe internal or external corrosion) and is unable to withstand the operating pressure of the system. A partially deteriorated pipe, which is expected to continue to corrode and deteriorate over its remaining design life, would also be considered a fully deteriorated pressure pipe in terms of the design of a renewal liner. Here the renewal liner needs to be designed to carry not only the full internal pressure, but also any external loads, including soil, live, and hydrostatic groundwater. In essence, the liner is a replacement for the existing pipe.

As is clear from the introduction to this section, Appendix X1 in ASTM F1216 is the most commonly accepted design method for CIPP and deformed/reformed thermoplastic pipes. It is interesting to note that the design appendix in ASTM F1216 is not mandatory, so in theory there is no obligation to use this design method when using CIPP products.

5.4.1.1 Partially Deteriorated Case. In the case of a partially deteriorated pipe, two basic equations are used in the design. The hydrostatic buckling resistance of the liner is calculated by the following formula:

$$P = \frac{2KE_L}{1-\mu^2} \times \frac{1}{(DR-1)^3} \times \frac{C}{N}$$

where:

- P = groundwater load, psi
- K = enhancement factor of the soil and existing pipe adjacent to the new pipe (a minimum value of 7 is recommended for design)
- E_L = long-term (time corrected) flexural modulus of elasticity for the liner, psi
- μ = Poisson's ratio (0.3 assumed)
- DR = dimension ratio (diameter/thickness) (D/t)
- C = ovality reduction factor
- N = factor of safety (2.0 is suggested)

The above equation is patterned after the classic Timoshenko elastic buckling formula for an infinitely long cylinder subjected to uniform external hydrostatic pressure. Modifications include the addition of the "enhancement factor" K and the ovality reduction factor. The enhancement factor is based mainly on hydrostatic buckling experiments published by Aggarwal and Cooper (1984) where buckling enhancement from the existing host pipe could range from 5 to 20 times greater than the free-standing liner. The ovality factor compensates for ovoid pipes and conservatively reduces the liner's resistance (refer to ASTM F1216 for the equation for C).

Most of the controversy over the application of the above formula stems from one's interpretation of the time corrected value for the modulus of elasticity, E_L . The note to Appendix X1.1 in ASTM F1216 states that the choice of value depends on the estimated duration of the application of the load (P) in relation to the design life of the structure (and should be obtained from the manufacturer's literature). If the total duration of the load is estimated to be 50 years, either continuously or over the sum of intermittent periods, then the appropriate choice for E_L will be that given for 50 years of continuous loading. However, no method of test for determining the long-term modulus, E_L , is referenced in ASTM F1216 or any of the product standards. Therefore, the method of determination could vary considerably depending on the method employed by the manufacturer. A flexural creep test under constant load would be one way of arriving at a value, but the value here will also be dependent on the load. The ISO standards for GRP pipe do contain requirements for the manufacturers to carry out long-term flexural creep or relaxation tests, and then to report the results for design purposes. The creep and relaxation tests specified have been set up to yield similar results independent of the method chosen. It would seem logical that the CIPP industry should consider adopting a similar methodology for their liner materials given that they too are composites made from the same resins (polyesters, vinyl-esters and epoxies). As this long-term property is key in the design of all gravity CIPP and deformed/reformed thermoplastic pipes, a great deal of development effort is exerted by renewal liner manufacturers to enhance this value. The addition of glass fiber is one example of such enhancement.

The other criteria that must be met in a liner for a partially deteriorated host pipe is to bridge over any holes or gaps. Here, depending on the ratio of the hole diameter to pipe diameter, the liner is assumed to behave like a circular flat plate with fixed edges covering an open hole and subjected to transverse pressure only. This condition applies when the following equation is satisfied:

$$\frac{d}{D} \leq 1.83 \left(\frac{t}{D} \right)^{1/2}$$

where:

- d = diameter of the hole or opening, inch
- D = mean inside diameter of the original pipe, inches
- t = thickness of CIPP liner, inches

When this condition applies, the liner acts as a flat plate in bending to span the hole and the following formula applies:

$$P = \frac{5.33}{(DR-1)^2} \times \left(\frac{D}{d} \right)^2 \times \frac{\sigma_L}{N}$$

where:

- σ_L = long-term (time corrected) flexural strength for CIPP, psi

A similar note is included for the selection of σ_L as E_L , namely choosing a value that is consistent with the load duration. Assuming that a 50-year design life is expected from the liner, then a value for the long-term flexural strength of the liner material under constant load for 50 years is needed. As in the case of E_L , no test method is stipulated. This is another example where the CIPP liner industry could take a page out of the GRP pipe handbook and adopt one of their test methods. The ISO standard for GRP pipe includes a test method for determining the long-term ring bending strength of a composite ring subjected to constant loading in an aqueous environment.

The above equations have been primarily developed for use with CIPP products, while the deformed/reformed thermoplastic products have also adopted them. As there are few if any design guidelines for spray-on coatings, the TTC has been carrying out some tests on spray coatings for the rehabilitation of pressurized pipelines. The main purpose of the testing is to generate an empirical design equation to determine the needed thickness of a polyurethane lining given an internal operating pressure and size of damage zone. To do this, an experimental program has been conducted that consists of testing panels of a spray-on polyurethane coating, which are clamped into a test frame and subjected to uniform pressure on one side of the frame with the other side open to atmosphere. The openings in the test frame have been 3 and 4.5 inches (75 and 113 mm) in diameter. In addition to monitoring the pressure at which the test panels fail, the amount of deformation or bulge of the test panel was also measured and compared to analytical and finite element analysis model predictions. At the time of writing this report, the TTC is in the process of expanding the testing to other spray-on coatings (polyurea) with the intention to develop a generalized equation that incorporates key mechanical properties of the coating materials. With new structural spray-on lining systems entering the US market, this work will be very welcomed.

5.4.1.2 Fully Deteriorated Case. In the fully deteriorated case, the liner is designed to resist without buckling all of the external loads, including groundwater, soil, negative internal pressure (vacuum), and live loads. The equation offered in ASTM F1216 has been borrowed from the AWWA design manual for Fiberglass Pressure Pipe, M45. The equation takes into consideration the soil support offered to the original host pipe and the liner:

$$q_t = \frac{C}{N} [32R_w B' E'_s (E_L I / D^3)]$$

where:

- q_t = total external pressure on pipe (including negative internal pressure), psi
- R_w = water buoyancy factor (0.67 min. – see F1216 for equation)
- B' = coefficient of elastic support (see F1216 for equation)
- I = moment of inertia = $t^3/12$, in⁴/in
- D = mean inside diameter of the original pipe, inches
- C = ovality reduction factor
- N = factor of safety
- E'_s = modulus of soil reaction, psi
- E_L = long-term modulus of elasticity, psi
- Values for the modulus of soil reaction may be found in ASTM D3839.

As the liner pipe must be capable of supporting the full internal pressure without support from the original pipe, the required design thickness may be calculated from the following formula which relates the hoop tensile stress in a thin ring to the internal pressure:

$$P = \frac{2\sigma_{TL}}{(DR-2)N}$$

where:

- P = internal pressure, psi
- σ_{TL} = long-term (time corrected) tensile strength, psi
- DR = dimension ratio (diameter/thickness) (D/t)
- N = factor of safety

The note to this equation advises the user to choose a value for σ_{TL} from the manufacturer's literature, which is consistent with the estimated duration of the load. As was the case for the long-term flexural modulus, E_L , no specified test method is offered for determining the long-term tensile strength so it is left

up to each individual manufacturer. Both the fiberglass and thermoplastic pipe industries have established standardized methods for obtaining the HDB of their products. The HDB is a material property and is obtained by evaluating stress (strain) rupture data derived from testing pipe at various stress (strain) levels over extended periods of time with at least one data point beyond 10,000 hours. A similar approach by the CIPP industry for pressure applications in fully deteriorated conditions would standardize the design parameters used.

5.5 Installation Standards

The following section reviews the ASTM installation standards for PVC (Table 5-9), FRP/GRP (Table 5-10), PE (Table 5-11), and CIPP (Table 5-12) materials.

Table 5-9. ASTM Installation Standards for PVC Materials

Specification No.	Title	Application
ASTM F1867	<i>Standard Practice for Installation of Folded/Formed Poly (Vinyl Chloride) (PVC) Pipe Type A for Existing Sewer and Conduit Rehabilitation</i>	Winching of folded PVC Type A with heating and expansion by pressure
ASTM F1947	<i>Standard Practice for Installation of Folded Poly (Vinyl Chloride) (PVC) Pipe into Existing Sewers and Conduits</i>	Similar to F1867. Diameters 4-15 inch covered.

ASTM F1867

This standard covers the procedures for installing a pipe meeting ASTM F1871. Flow stoppage or by-pass pumping is required for the insertion. All protrusions greater than 12.5% of the inside diameter should be removed. Changes in pipe sizes can be accommodated providing the liner thickness is designed for the expansion. The liner can be pulled through bends up to 30°. The liner pipe (may be pre-heated to 180°F) is winched through the existing pipe. Pulling force should be limited to 50% of yield at 212°F. Using heat (steam) and pressure (typically 3 to 5 psi [0.2 to 0.33 bar]), the liner is expanded beyond extrusion memory to contact the wall of existing pipe. Dimples are formed at service connections. After expansion, the pipe liner is cooled to 100°F before relieving the pressure. In addition to CCTV inspection and leak tightness testing, field samples are prepared by expanding the folded PVC inside a mold pipe of the same diameter of the existing pipe and a minimum of one diameter in length. Dimensional checks (diameter, wall thickness) and flexural and tensile properties are measured on the field sample.

ASTM F1947

This standard covers the procedures for installing a folded PVC pipe meeting ASTM F1504. This standard is similar to ASTM F1867. An optional elastomeric containment tube may be used to protect the folded pipe during installation and to act as a waterproof barrier against infiltration and for containment of the steam. Expansion pressures are in the range of 8 to 10 psi (0.55 to 0.70 bar). Pipe diameters covered are 4 to 15 inches (100 to 375 mm). The inspection and acceptance requirements differ from ASTM F1867 in that no tensile properties of the formed pipe are checked, only the flexural modulus. The minimum flexural modulus is 280,000 psi (1931 bar) (cell classification 13223 per ASTM D1784).

Table 5-10. ASTM Installation Standards for FRP/GRP Materials

Specification No.	Title	Application
ASTM D3839	<i>Underground Installation of Flexible Reinforced Thermosetting Resin Pipe and Reinforced Plastic Mortar Pipe</i>	Direct burial, not suitable for sliplining or microtunneling applications

ASTM D3839

This standard provides procedures for the installation of fiberglass pipes in typical soil conditions. Pipes with diameters up to 144-inches (3,657 mm) and pipe stiffness from 9 to over 72 psi (0.62 to over 5 bar) can be installed following the guidelines embedded in this practice. Soils are classified into stiffness classes and corresponding compaction levels recommended to achieve a minimum passive soil modulus (E') of 1,000 psi (70 bar). Situations for handling running soils and trench supports are included. This standard is only applicable for direct buried pipes.

Table 5-11. ASTM Installation Standards for Polyethylene Materials

Specification No.	Title	Application
ASTM F1606	<i>Standard Practice for Rehabilitation of Existing Sewers and Conduits with Deformed Polyethylene (PE) Liner</i>	Covers installation of deformed PE liner meeting ASTM F1533.

ASTM F1606

After cleaning and inspection of the existing pipe, the deformed PE pipe is pulled directly through the insertion point to the termination point. The pulling force should not exceed the axial strain limits of the deformed pipe, which is accomplished by limiting the pulling force to a tensile stress of 1,500 psi (103 bar) or 50% of the yield. The steam temperature for reforming is to be between 235°F and 260°F, with pressure starting at 29.2 psi (2 bar) and rising to 40.7 psi (2.8 bar). The reformed pipe is cooled to 100°F with the internal pressure increased to 47.7 psi (3.3 bar), while the liner is cooled to ambient temperature. Acceptance testing includes dimensional checks of the outside diameter and installed wall thickness, along with flexural and tensile properties of a reformed field sample prepared at the insertion or termination point. CCTV inspection is also recommended.

Table 5-12. ASTM Installation Standards for CIPP Materials

Specification No.	Title	Application
ASTM F1216	<i>Standard Practice for Rehabilitation of Existing Pipelines and Conduits by the Inversion and Curing of a Resin-Impregnated Tube Rehabilitation</i>	Covers 4–96 inch CIPP inversion insertion and hot water or steam cure.
ASTM F1743	<i>Standard Practice for Rehabilitation of Existing Pipelines and Conduits by Pulled-in-Place Installation of Cured-in-Place Thermosetting Resin Pipe (CIPP)</i>	Covers 4–96 inch CIPP pulled in place insertion, inflation with calibration hose, and hot water or steam cure.
ASTM F2019	<i>Standard Practice for Rehabilitation of Existing Pipelines and Conduits by the Pulled-in-Place Installation of Glass Reinforced Plastic (GRP) Cured-in-Place Thermosetting Resin Pipe (CIPP)</i>	Covers 4–48 inch CIPP pulled in place insertion, air inflation and steam or UV light cure.

ASTM F1216

This reconstruction process can be used in gravity and pressure applications. The CIPP product is expected to have the minimum structural properties in Table 5-13. As part of the inspection and acceptance process, F1216 requires that two samples be prepared for testing, one taken from an intermediate manhole or at a termination point that has been inverted through a like diameter pipe with a suitable heat sink, and the second fabricated from material from the tube and the resin/catalyst system and cured in a clamped mold. Physical property testing includes short-term flexural and tensile properties.

For pressure applications, a hydrostatic pressure test is suggested for twice the working pressure or working pressure plus 50 psi (3.5 bar), whichever is less. The allowable leakage rate over the one-hour test is 20 gallon/inch diameter/mile/day.

Table 5-13. Minimum Structural Properties of CIPP Products by ASTM F1216

Property	Test Method	Minimum Value psi
Flexural Strength	D790	4,500
Flexural Modulus	D790	250,000
Tensile Strength (pressure pipe only)	D638	3,000

ASTM F1743

This process may be used in a variety of gravity and pressure applications. CIPP products conforming to ASTM D5813 would be installed following this standard practice. An outer impermeable plastic coating may optionally be perforated to allow resin to be forced through and out against the existing pipe wall during the calibration with pressure. The minimum initial physical properties of the CIPP product are presented in Table 5-14. This practice also contains a chemical resistance requirement. On a qualification basis, the cured resin/fabric tube matrix must retain 80% of its flexural modulus after one year exposure at 73.4°F to five different reagents. The exposure is not under a strained condition. Recommended inspection practices includes obtaining at least three, and preferably five, samples of the CIPP taken at either intermediate manholes, or termination points, or fabricated from material placed and cured in a clamped mold. In addition to testing for the flexural properties, for pressure applications, tensile testing is also required. If the CIPP is fiber reinforced with oriented or discontinuous fibers, then tensile testing in both the axial and circumferential direction is recommended. Pressure pipes should be subjected to a hydrostatic pressure test of twice the working pressure, or working pressure plus 50 psi (3.5 bar), whichever is less. If required by the purchaser, a delamination test in accordance to D903 is also to be made.

Table 5-14. Minimum Structural Properties of CIPP Products by ASTM F1743

Property	Test Method	Minimum Value psi
Flexural Strength	D790	4,500
Flexural Modulus	D790	250,000
Tensile Strength (pressure pipe only)	D638	3,000

ASTM F2019

The reconstruction process can be either for gravity flow or pressure applications. CIPP liners meeting ASTM D5813 would be installed under this practice. Isophthalic polyester, vinyl ester, or epoxy thermosetting resins may be used. For cleaning of the line for pressure applications, cable attached devices or fluid propelled pigs are recommended. After CCTV inspection and cleaning, a sliding plastic foil is first installed covering the lower third of the circumference to reduce friction and damage to the CIPP liner. After insertion, the calibration hose is inflated and the liner cured. The calibration hose is removed after cure. As in all of the CIPP standard practices for acceptance, samples of the CIPP liner are either cut from a section at an intermediate manhole or at a termination point of like diameter section, or

from material taken from the fabric tube along with the resin/catalyst system and cured in a clamped mold. Since the glass fiber material can be bi-axial, samples are marked to designate the axial and circumferential direction. Testing includes short-term flexural and tensile properties. The minimum acceptable properties under this standard are shown in Table 5-15.

Table 5-15. Minimum Structural Properties of CIPP Products by ASTM F2019

Property	Test Method	Minimum Value psi
Flexural Strength	D790	6,500
Flexural Modulus	D790	725,000
Tensile Strength	D638 or D3039	9,000

In addition, wall thickness measurements are made (with no point measurement to be less than 85% of the average design specified thickness) and a CCTV internal inspection is completed. As F2019 covers pressure applications, a pressure and leak tightness hydrostatic pressure test is included with a recommended test pressure of twice the working pressure or working pressure plus 50 psi, whichever is less. Allowable leakage is 20 gallon/inch diameter/mile/day.

5.6 QA/QC Requirements

Few rehabilitation products are destined specifically for use in a sewer force main. Consequently, most of the QC requirements in the ASTM and AWWA standards pertain to either use in a gravity sewer or a pressure water main. None, except ASTM D3754, which covers fiberglass pipe for sewer and industrial pressure pipe, combines the corrosion resistance necessitated by the sewer effluent and the long-term tensile strength of a pressurized main. As more rehabilitation work is undertaken in the field of sewer force mains, new standards or revisions to existing standards should follow to reflect this unique application and need.

QC is a procedure or set of procedures intended to ensure that a manufactured product or performed service adheres to a defined set of quality criteria or meets the requirements of the client or customer. QA is defined as a procedure or set of procedures intended to ensure that a product or service under development (before work is complete, as opposed to afterwards) meets specified requirements. Typically in the world of construction, the QA aspects of a project are intended to assure the owner that the contractor's or vendor's QC practices are adequate to deliver the product or service that the owner has contracted.

Some of the product standards do require the manufacturers to undertake qualification or "type" testing, which is intended to demonstrate the long-term performance of the liner under the intended use conditions. However, the amount of this testing is very limited. Post-installation CCTV is the most common QC requirement for all liners followed by the retrieval of samples for physical property verification. More details on these requirements can be found in the following sections on short-term and long-term QA/QC requirements in factory and field settings.

5.6.1 Short-Term – Factory and Field Requirements

5.6.1.1 PVC Short-Term QA/QC Requirements

Folded PVC

The short-term QC requirements in the factory for folded PVC pipes include pipe flattening, pipe impact strength, pipe stiffness, extrusion quality (acetone immersion, heat reversion), and flexural properties.

Dimensional checks on the pipe diameter and wall thickness are also included. The pipe flattening and impact requirements are designed to primarily ensure that the pipe can be folded and reformed during the installation without damage, while the stiffness and flexural properties relate to the design. There are no QC requirements on measuring tensile strength, while the Type A material is to be made from virgin PVC with a minimum tensile strength of 3,600 psi (248 bar).

Neither of the ASTM standard practices for the installation of folded PVC pipes (F1867 and F1947) is for pressure applications. Consequently, the only field QC requirements pertain to gravity service. A low pressure leakage test with a limiting exfiltration level of 50 US gallon/inch diameter/mile/day is recommended. Samples of the rounded pipe are also retrieved at the insertion point, with diameter, thickness and flexural properties measured. For the Type A material, ASTM F1867 also includes testing for tensile properties (3,600 psi [248 bar] minimum).

5.6.1.2 PE Short-Term QA/QC Requirements. In pressure applications, the majority of the rehabilitation that has been undertaken with PE pipe has been either with pipe bursting or sliplining. Pipes used in these applications normally meet either AWWA C901 or C906, or the ASTM specification for OD controlled pipe, ASTM D3035. Typical factory QC requirements in each case include visual inspections for workmanship (no cracks, holes, foreign inclusions, etc.), diameter and wall thickness checks, density measurements (per ASTM D1248), sustained pressure tests (subject the wall to a hoop stress equal to the hydrostatic design stress), burst pressure tests (1.6 times the HDS for PE 3408), environmental stress cracking tests, elevated temperature sustained pressure tests, and apparent ring tensile strength tests.

In the case of sliplining, the original pipeline is visually inspected in the field by CCTV to locate problem areas, including offset joints, crushed walls, obstructions and the location of service connections. The only ASTM standard practice for the insertion of PE pipe, F585, is for gravity applications and includes only a low pressure exfiltration test for acceptance, which is not particularly useful in a force main application. The AWWA M45 *PE Pipe – Design and Installation* manual provides some guidelines on the use of PE pipe for pipe bursting and sliplining, but does not contain any specific field QC test requirements except recommending a hydrostatic pressure test for acceptance.

Deformed PE

In the factory, deformed PE liners are dimensionally checked, plus evaluated for ESCR, tensile strength, tensile elongation, and flexural modulus. These tests are part of the normal qualification and QC requirements. The PE liner is required to have a minimum HDB, which would previously have been demonstrated through type testing. The HDB rating of the resin is used for pressure design. The only ASTM standard practice for the insertion of a deformed PE liner in a sewer, ASTM F1606, is for gravity applications. QC requirements include a CCTV inspection of the liner after insertion and reversion, an exfiltration or low pressure air test for leakage, and taking samples at the insertion or termination point for further analysis. This would include diameter and wall thickness checks, plus measurement of flexural modulus and tensile strength.

5.6.1.3 CIPP Short-Term QA/QC Requirements. As such, there are no ASTM CIPP product specifications covering pressure applications, but ASTM D5813 *Standard Specification for Cured-in-Place Thermosetting Resin Sewer Pipe* does require the fabric tube to have a minimum tensile strength of 750 psi (52 bar). This pertains more to handling and insertion needs than actual in situ performance.

Once the CIPP liner is installed, the recommended QC practice in all of the ASTM standards is for samples to be cut from a representative section of the cured CIPP liner and then tested for short-term flexural strength and modulus and short-term tensile strength. Two methods (ASTM D3039 and ASTM

D638) are offered for determining the tensile strength. The minimum value is 9,000 psi (621 bar) as specified in ASTM F2019, which is the only standard practice for pressure applications.

Wall thickness measurements are also made on the retrieved samples. There is no requirement for measuring the wall thickness of the in situ liner. Theoretically, this is now possible with the use of a laser profiler. The inside surface of the original pipe would first be surveyed with the profiler and then the liner's inside surface after cure. Assuming the liner hasn't shrunk away from the inner surface of the original pipe, the thickness of the liner could then be determined from these two survey measurements. Ultrasonic tools are also being developed that not only can be used to measure the thickness of the in situ liner, but also its flexural modulus of elasticity. This could be especially important to an owner who may want to check on the condition of an old liner to determine if any deterioration (loss of thickness or modulus) has taken place.

Another QC requirement often required is leak tightness testing, which in the case of a pressure pipe has a limit of 20 US gallon/inch diameter/mile/day. The recommended pressure level in ASTM F2019 is twice the working pressure or the working pressure plus 50 psi (3.5 bar), whichever is less.

The last field QC requirement is a visual inspection, usually by CCTV, to check workmanship. No dry spots, lifts, or delaminations that would affect the liners long-term performance are permitted. Excessive wrinkles are also not permitted, especially those that impede flow or cleaning equipment.

5.6.2 Long-Term – Qualification Requirements

5.6.2.1 PVC Long-Term QA/QC Requirements. PVC pipe meeting AWWA C900 or C905, or ASTM D2241 *Standard Specification for Polyvinyl Chloride (PVC) Pressure-Rated Pipe (SDR Series)* is subjected to long-term pressure regression testing to establish an HDB for the pipe. Pipes are tested per ASTM D1598 and the results analyzed in accordance with ASTM D2837. A Hydrostatic Design Stress (HDS) is determined, which is the maximum tensile stress the material is capable of withstanding continuously with a high degree of certainty that failure of the pipe will not occur. Fusible PVC and Duraliner are the only two PVC products made from standard AWWA C900 or C905 stock, so these are qualified.

Folded PVC

There are no long-term qualification requirements in the folded PVC liner standards. Only one manufacturer of a folded PVC product, Ultraliner, stipulates that this product could be used for a low pressure sewer force main renewal. At some point in the future, a requirement similar to that in AWWA C900 or AWWA C905, where reformed pipes are subjected to long-term pressure regression tests needs to be established. This would then allow design of a reformed PVC liner to act as a fully structural pipe for 50 years. At the present time, that information is not available.

5.6.2.2 PE Long-Term QA/QC Requirements. PE pipe meeting AWWA C901 or C906, or ASTM D3035 is similar to PVC in that these products are also subjected to long-term pressure regression testing. These tests establish a basis for the long-term pressure rating of the products. There are no other long-term tests for standard PE pipe.

Deformed PE

PE used for deformed liners under ASTM F1533 is to be made from materials that have a PPI HDB of either 1,600 psi (110 bar) for PE 3408 or 1,250 psi (86 bar) for PE 2406. However, there is no requirement for the reformed PE liner to demonstrate that it has a similar HDB rating.

5.6.2.3 CIPP Long-Term QA/QC Requirements. ASTM D5813 includes a long-term qualification test for chemical resistance, which includes two requirements. The first is that the CIPP specimens retain 80% of their flexural modulus of elasticity after one-year exposure to six chemical solutions. Table 5-16 lists the solutions and their concentrations.

Table 5-16. ASTM D5813 Chemical Solution Specifications

Chemical Solution	Concentration %
Nitric acid	1
Sulfuric acid	5
ASTM Fuel C	100
Vegetable oil	100
Detergent	0.1
Soap	0.1

The other chemical resistance requirement is the strain corrosion test requirement of ASTM D3681, developed for fiberglass pipes used in gravity sewers. Eighteen (18) samples are deflected to achieve four different tensile bending strains on the inside surface of the liner and with exposure to H₂SO₄. The samples must last without failure for the specified time period associated with each strain level. This qualification test is intended to ensure that the liner is capable of withstanding up to 5% long-term vertical deflection when exposed to 5% H₂SO₄ and will last 50 years. This requirement may be valid for a direct buried pipe or perhaps a liner that is destined to be fully structural and capable of supporting all external loads, but is not realistic for a liner installed in a partially deteriorated sewer force main.

6.0 OPERATION AND MAINTENANCE

This section reviews best practices for O&M that can be effective in either prolonging the life of a buried sewer force main or allowing a utility to monitor real-time performance so action can be taken as needed to repair, rehabilitate, or replace the force main before a catastrophic failure occurs. Proper cleaning can improve the capacity and hydraulic performance of a sewer force main. Several other methods are available for improved O&M, including cathodic protection to arrest the effects of external corrosion, linear polarization resistance (LPR) to determine a rate of external corrosion, ultrasonic transducers to monitor loss of internal wall due to corrosion, pressure monitoring, leak detection, and acoustic monitoring of PCCP for wire breaks. These are all methodologies that a force main owner can employ to better manage and prolong the life of the buried asset. As discussed below, the ability of a utility's repair crews to skillfully carry out emergency repairs on lined force mains is also cited as one deficiency that limits the use of renewal technologies over replacement, even when their life-cycle costs are lower.

6.1 Procedures to Prolong the Life of Existing Force Mains

6.1.1 Cleaning. Unlike gravity sewers, force mains are not designed to be self-cleansing. As a result, solids, fats, and greases can accumulate in the main. Operational records can show when a force main is in need of cleaning. One useful indicator is the volume of flow per unit of electricity consumed (m^3/kW); if this reduces significantly then it indicates greater resistance to pumping, which is likely to be build-up of debris or encrustation on the pipe surface. Many contractors report that cleaning of force mains, usually by pigging, produces a greater impact than cleaning of water mains. Cleaning methods fall into two categories: those that dislodge the solids so that they are carried away with the wastewater flow and those that remove the solids from the pipeline. Pigging, vacuum jetters, and bucket dredging remove the solids. High pressure water jetting and mechanical rodding are methods that dislodge the solids.

Pigging

Water jetting may be used for cleaning pressure pipelines, but there is also a wide range of tools ranging from wire brushes and squeegees to motor-driven flails for use in iron pipes. In some cases, the pressure in the main may be used to force a pig through the entire line, with no need for winching. The bullet-shaped pigs are commonly made of polyurethane and have surface coatings and/or wire brushes that scrape off the deposits as they travel through the pipeline.

The most commonly used pig for cleaning is the versatile poly pipeline cleaning pig, which is thrust through the pipeline by hydraulic or pneumatic pressure to clean the interior walls, remove debris, and flush liquids from the pipeline. A selection of such pigs is shown in Figure 6-1.

Pigging requires high volumes of water at high pressure to force the pig through the line. Volumes above 100 gal/min may be required even in quite small mains and a significant pressure should be applied. Care must be taken not to exceed the design pressure of the pipe itself during pigging. Large volumes of debris and sludge can accumulate at the downstream end of the pigged pipeline and these must be captured to avoid their flowing into the sewer system and simply moving the problem further downstream.

Pigging also requires access to the force main for pig insertion. Force main systems are seldom, if ever, designed with pigging in mind, so this may be a major operation unless access can be provided at the pump station. Since force mains generally terminate at a manhole or discharge into a gravity sewer, recovery of a pig is relatively straightforward.



Figure 6-1. Polyurethane Pipeline Cleaning Pigs
(Photo courtesy of Pipeline Pigging Products)

High Pressure Water Jetting

Jetting has become very common, yet is limited in its capabilities. It is currently the most popular cleaning method for gravity sewers and is widely used throughout the world. Jetting machines range from compact van-pack units for cleaning small diameter drains, through trailer-mounted jetters of various power ratings, to full tanker-jetters (which may also combine vacuum removal) up to the largest unit of a water recycling facility.

Although high pressure jetting can achieve excellent results if used wisely, it also has the potential to make a bad situation worse and to create problems where none existed. Jetting a cracked or fractured pipe may cause the fragments to become loose and fall into the pipe, creating a collapse and a blockage. Persisting with high pressures in an attempt to remove the blockage can wash away the pipe surround, resulting in further destabilization and perhaps even subsidence at the surface. Leaving a high pressure jet in one position for more than a few seconds may puncture the pipe or damage the wall, even if the pressure is below the recommended maximum.

There is some risk in jetting at high pressure in plastic pipes, notably uPVC. Generally, the wall thickness of a solid wall uPVC pipe is such that high pressure jetting is unlikely to cause serious damage, although excessive pressures should be avoided. The main concern is with structured wall polymeric pipes where most of the strength is provided by external ribs or corrugations, and the inner wall can be quite thin (sometimes less than 2 mm). Structured wall pipes were introduced to reduce the required quantity of material (and hence the weight and cost) for medium to large diameters, while providing adequate stiffness to resist external loads.

The main drawback of high-pressure jetting is that the debris in the sewer can be flushed downstream rather than being removed. Jetters may be excellent for clearing localized blockages, but are less well suited to dealing with large volumes of silt or similar material over long lengths of sewer.

Drain Rodding

Simple drain rods are an obvious low-tech alternative to water jetting for small-bore pipes. For small diameter pipes, old-fashioned drain rods are still the most common tool for blockage clearance and can be very effective. The limitation is that there is little control and no feedback as to whether the blockage is adequately cleared. Another drawback is that the rods may simply be pushing the problem somewhere else. Nevertheless, this is an effective method for removing small blockages in small diameter sewers. It is less well-suited to force mains because they generally have higher flow rates than gravity sewers so are less likely to have loose debris in the invert.

Removal

Pipe cleaning and blockage clearance should involve more than just passing the problem downstream, which jetting and rodding may do. Jetters are better than rods in this respect, since they break up accumulations of debris into finer material, which is more likely to be carried in the flow and dispersed. Where there are greater volumes of debris that would almost certainly settle out further downstream, a common solution is to use a combination jetter/vacuum machine to simultaneously flush the sewer and suck out the resulting sludge. Some of the larger and more sophisticated units incorporate water filtering and recycling systems, together with compression of the solids so they take up less space and are easier to dispose.

Flushing

Flushing involves simply pouring a large volume of water into a sewer as quickly as possible so that the sudden increase in flow will wash away any accumulations of debris. It is an attempt to replicate the effect of a summer storm on a combined sewer. Today, such a procedure would be carried out using a large-capacity tanker-jetter, possibly with recycling and filtering facilities. Flushing is seldom used since it has been largely superseded by jetting. Jetting uses less water and is a more controllable and reliable technique. Flushing is also not well-suited to force mains since it does little more than repeat the normal operation of the main.

Air Scouring

Air scouring is flushing with a twist. The “twist” in air scouring is using alternating volumes of air and water to flush the pipe. The air and water travel along the pipe in separate discrete volumes with approximately 75% air and 25% water. The air causes the water to move with high velocity and turbulence, scouring away sediment, soft scale deposits, and biofilm. Common air compressors provide the air. Both fluids are fed continuously and separately into discrete volumes by themselves. Air scouring is more aggressive than flushing and should be used with caution if the pipe’s structural condition is poor. The AWWARF research report, *Investigation of Pipe Cleaning Methods*, provides further details on the equipment setup for this method (AWWARF, 2003).

6.1.2 Cathodic Protection. Approximately 60% of ferrous force mains reportedly have some cathodic protection applied. Steel pipes are more commonly protected with a cathodic protection system because the electrical continuity of welded joints makes this a practical solution. It is more complicated for DI pipe where electrical connectors (bonding) need to be placed across all bell and spigot joints.

Cathodic protection is an electrochemical method used to prevent or control corrosion of buried or submerged metallic structures. They are active systems that rely on the application of electric current to control corrosion. If current is interrupted, corrosion will progress at the normal rate for the material/environment combination; if the supplied current is inadequate for complete protection, corrosion will progress at a reduced rate. After a cathodic protection system has been installed and adjusted to provide adequate protection, currents and potentials should remain relatively stable; changes

in currents or potentials indicate a problem. There are two principal types of cathodic protection system: impressed current and sacrificial anode as follows:

- **Impressed Current Cathodic Protection.** An impressed current system uses a rectifier to convert alternating current to direct current. This current is sent through an insulated wire to the anodes, which are special metal bars buried in the soil near the pipeline. The current then flows through the soil to the pipeline and returns to the rectifier through an insulated wire attached to the pipeline. The pipeline system is protected because the current going to it overcomes the corrosion-causing current normally flowing away from it.
- **Sacrificial Anode Cathodic Protection.** Sacrificial or galvanic anode systems employ reactive metals as auxiliary anodes that are directly electrically connected to the pipeline to be protected. The difference in natural potentials between the anode and the pipeline metal, as indicated by their relative positions in the electro-chemical series, causes a positive current to flow in the electrolyte, from the anode to the pipeline. Thus, the whole surface of the pipeline becomes more negatively charged and becomes the cathode. The metals commonly used as sacrificial anodes are aluminum, zinc, and magnesium. These metals are alloyed to improve their long-term performance and dissolution characteristics.

Maintenance and monitoring of cathodic protection systems is seen as very important by the operating utilities. System performance can be monitored by measuring the supplied current, by measuring the potential of the structure, or (preferably) by a combination of the two methods. Scheduled maintenance may include inspection and adjustment of equipment items, such as current rectifiers or anodes; unscheduled maintenance may include troubleshooting and repair of items identified as defective during scheduled inspections, such as anode beds or electrical conductors.

Cathodic protection systems need to be checked at least once every two to four years to make sure they are functioning. Unfortunately, all too often, the systems are ignored until there is a failure in the assumed to be protected pipeline. Testing the system is relatively straightforward, but special equipment is necessary to perform the test. Each cathodic protection system has a test box(es) installed to facilitate checking the system. Transformer rectifier outputs may be displayed by telemetry at central control stations. Many cathodic protection systems are increasingly being controlled and monitored by remote computers and modem links. An important aspect of good maintenance techniques is record keeping. Without proper record keeping, a maintenance program is essentially useless. Proper record keeping not only provides historical data for future cathodic protection design, but also often provides clues as to the source of a detected deficiency. The required recordkeeping for proper maintenance is relatively simple.

6.1.3 Continuous Corrosion Monitoring. Knowing where conditions exist that can give rise to corrosion is an important element in buried pipeline operation, including force mains. Corrosion of ferrous pipes may be external or internal.

Likely locations of internal corrosion in force mains are at high points where air may be present and at downstream discharges. Well-designed pressure pipe systems have air valves at high points and records showing frequent air valve operation and significant volumes of air being bled can indicate potentially corrosive conditions. Most force mains discharge to gravity lines and at the discharge point the pipe seldom runs full. The presence of air can cause corrosion at these locations.

The risk of external corrosion can be identified from knowledge of the soil and groundwater conditions. Procedures for establishing the corrosivity of soils are well established. Environmental factors that determine the likelihood of corrosion on a buried ferrous force main are: soil resistivity; soil moisture

content; soil and groundwater pH; chlorides; sulfates; redox potential; and known corrosive environments.

Continuous corrosion monitoring systems can be installed when new pipelines are laid, or can be added retroactively to existing pipelines. Monitoring implies a series of surveys, planned and organized, to obtain more comprehensive information on conditions over time. By defining changes in corrosion conditions over time, this represents a longer-term commitment compared with one-time corrosion inspections or surveys. It also represents a deeper commitment to quantifying the rate of corrosion and determining underlying causes of corrosion damage. It has been noted that the rate of corrosion ultimately determines how long a process can be operated usefully and safely. Thus, there is value in knowing this rate to identify when maintenance action needs to be taken. Most importantly, to generate real value from corrosion monitoring initiatives, the information gathered over time has to be translated into effective corrosion mitigation or control programs.

Corrosion monitoring is mainly used in installations such as critical operations in chemical processing plants and oil and gas wells and offshore pipelines. Its use in force mains could not be documented at this time, but that may change in the future. GE Inspection Technology has acquired the technology for an ultrasonic sensor that is actually made up of a series of 14 thin transducers, all in a flexible band that is 240 mm long by 40 mm wide. This band can be wrapped around the outside of a ferrous pipe in either the circumferential or axial direction. The accuracy of the transducers is reported to be 0.2 mm. A coaxial cable is led to a box at grade level where periodic measurements of the 14 transducers can be made with the DL datalogger. The Rightrax M2 has been used on steel pipe, but not yet on DI pipe.

Another approach is the use of a corrosion potential indicator called, LPR (Figure 6-2). Developed in Australia by Tyco Water, this is used to evaluate external corrosion in the form of pitting based on soil aggressivity. This is not a new concept, but Tyco Water has refined the approach. LPR soil testing is an electrochemical soil testing technique using soil samples taken from the pipe depth to obtain a quantitative measure of soil corrosivity and rate of corrosion. Previous attempts at measuring soil corrosivity by a range of chemical and physical parameters have not been very successful because what is obtained is the thermodynamic tendency for corrosion to occur. The LPR approach provides a corrosion rate that can be extrapolated to allow a quantitative time to failure to be calculated. The process involves the use of a specially developed cell that provides a measure of the combined effects of several soil parameters. Comparison of the results from LPR surveys and direct measurement of pitting have shown a close relationship. The assessment and time to failure calculation takes into account the pipe class, age, length of main, and type and life of the pipe coating.

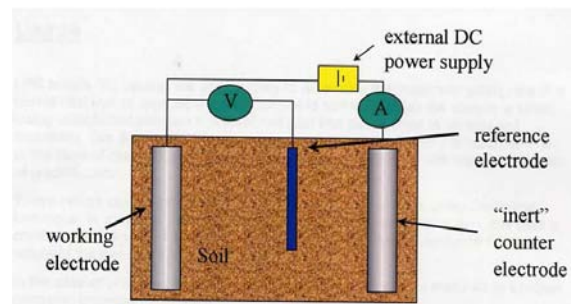

Figure 6-2. LPR Ferguson-Nicholas Cell

The method is stated to have the advantages of being: relatively low cost; non-intrusive, able to be undertaken with the line in operation; and proven on a number of inspections. The interpretation of results requires specialist skills. Results can be extrapolated in time and space to provide projections of potential failure. The LPR is currently used in Australia and Hong Kong, but has not been used in North America to date.

6.1.4 Pressure Monitoring. Stress in a pipe wall is a function of internal pressure. When a pipe is known to be deteriorated, reducing the operating pressure can extend its service life and reduce the risk of its failure. Transient pressure monitoring is becoming an accepted O&M procedure in water supply and

could also be used in force mains. Pressure sensors are attached to the pipe and monitored over a period of time. This monitoring can be done remotely and the data captured and analyzed to provide a graphical display of pressure over time. Pressure monitoring can indicate potential risk due to fatigue loading of the pipe and to transient pressure surges. Force mains, in which pumps are frequently started and stopped, undergo significant cyclical loading. Transient pressures, also known as surge or water hammer events, are the result of sudden changes in the velocity of liquid in a pipeline. Even very short-term (less than 1 second) pressure transients can cause damage to pipes if they are repeated frequently. Transient pressures that exceed the structural strength of the pipe can cause damage in the form of rupture or more frequently cause latent damage that results in a failure in the future. PVC can be especially vulnerable to fatigue failure, especially older pipes where formulations are different from those used today. Similarly, negative pressures can also be a source of damage to pipes.

6.1.5 Leak Monitoring. Leakage in a pressurized main can be a precursor of failure. Typically, over time, leakage will increase and eventually may disrupt the bedding and support of a buried pipeline. That can lead to differential settlement and either a failure at a joint or in the barrel of the pipe. Consequently, identification of the location of leaks in a force main could be an important element in any condition assessment program, as well as in the normal operation of a force main.

Leaks can fall into two categories: joint leaks and pipe wall leaks. Leaks arising from perforations in the pipe wall have greater significance. Not only can they be a source of pollution, but they are also a clear indicator of significant corrosion and an indicator of potential future failure. At the very least, they provide a focus on where to use structural integrity investigation methods.

Just 21% of the responding utilities to the WERF research project on inspection of force mains (WERF, 2009) stated they have performed leak detection on force mains. The most common method for leak detection reported was a field hydrostatic test, where either loss of pressure or fluid is used to identify the presence of a leak in a line. Of course, this requires isolation of the line for the duration of the test and will not pinpoint the actual location of the leak. The hydrostatic field test is usually limited to new lines as part of the acceptance requirements.

Leak detection uses a variety of techniques including acoustic, hydrophones, tracer gas and infrared thermography. Leak detection is of importance in the investigation of force mains and a number of new developments are providing cost-effective tools for this purpose. External technologies fall broadly into two types: acoustic sticks (listening devices) and correlators. Ferrous force mains have similar leakage defects as are found in ferrous water mains and some of the tools from the water industry could be used with some adaptation. In-line leak detection can be an effective means of undertaking leak surveys on ferrous force mains. It is a relatively new development for force mains having been initially developed for potable water main leak investigation. Virtually all diameters and pipe materials can be investigated with the mains in normal operation. The two principal technologies used in water mains are Sahara[®], offered by Pressure Pipe Inspection Company (PPIC) and SmartBall[®] by Pure Technologies, Ltd. Both have been used successfully in force mains and have the added benefit of being able to detect and locate air pockets, which can be indicators of corrosion in force mains. Sahara[®] employs a tethered hydrophone, while the SmartBall[®] is free swimming. The minimum pipe diameter is 12-inch (300-mm) for Sahara[®] and 10-inch (250-mm) for SmartBall[®].

6.1.6 Acoustic Monitoring for Wire Breaks in PCCP. One of the primary failure mechanisms for PCCP is wire breakage. Real-time monitoring for ongoing wire breaks can enable a picture to be built up over time of the rate of wire breaks and more importantly, any concentrations of breakage. These can indicate locations where corrosion is causing rapid deterioration of the pipe and where intervention is necessary to prevent a failure. The wire breaks can be detected acoustically. This technique can be used

in all diameters of pipe, not just those where man entry is possible. There are four possible types of installation and the requirements for installation will vary according to the method as listed below:

- *Hydrophone Arrays:* Up to 32 hydrophones can be mounted on a cable up to a mile long. The cable and hydrophones can be inserted into an operational pipeline. One advantage of this approach is that it is possible to have close hydrophone spacing cost-effectively. Data are transmitted through the cable to a data acquisition center.
- *Hydrophone Stations:* Hydrophones are inserted into the flow at convenient stations by making 1 inch taps under pressure. Data from each hydrophone are transmitted to a data acquisition center.
- *Surface mounted sensors:* Piezoelectric sensors (accelerometers) are surface mounted on the pipe and data are transmitted above ground to a data acquisition center.
- *Fiber Optic Sensors:* These consist of a long jacketed cable with internal continuous glass fiber sensor, which is able to transmit light. As the whole of the fiber is the sensor, it is in close proximity to any wire break. In addition, fiber optic can also be set up to monitor pressure and temperature.

The acoustic data from these installations are collected and transmitted by wireless internet to the company for analysis. The two companies that undertake this monitoring have variations on installations depending on location and pipe diameter. They both have developed their own procedures and software for analysis of data. They both claim to be able to separately identify wire break noise and its location from other acoustic events. It may even be possible in the future to distinguish third-party damage events. Using this data and analysis, they can estimate the state of distress of each pipe section.

6.2 Maintenance and Emergency Repair of Rehabilitation Systems

Maintenance departments at utilities have set procedures for emergency repairs of force mains. These are dependent on material, type of emergency (break, leak, joint leak, etc.), and location. A rehabilitated main effectively adds to the range of material that must be potentially repaired in an emergency. There are no set procedures for repair of rehabilitated (i.e., lined) force mains. This is an area of concern for utilities and certainly makes them reluctant to line their mains because they do not know how to deal with them when emergency repair becomes necessary. This further influences the choice of replacement over rehabilitation. The onus is on the suppliers of lining technologies to develop repair procedures for their products in force main applications and to train utilities in their application. Procedures that require the vendors' personnel to attend and undertake specialist works will not be adequate in emergency situations where swift action is necessary.

7.0 GAPS BETWEEN NEEDS AND AVAILABLE TECHNOLOGIES

All of the tools for force main system rehabilitation programs are not yet in place. This section addresses the gaps that need to be closed in order to provide utilities with the decision-making processes and the rehabilitation technologies necessary to develop such programs. The first section will address data gaps in terms of knowledge of the host pipe condition and the second section will address capability gaps in terms of available renewal technologies.

7.1 Data Gaps

The data gaps between needs and available technologies are significant.

The available inspection technologies can obtain the required data concerning the condition of force mains, which is necessary for assessment and renewal design purposes. But these technologies cannot be used cost-effectively or without shutdown of the main, which is generally not possible or entails major cost. Data may be obtained either externally or internally. External data require excavation for inspection on the pipe surface. For reasons of cost and practicality, this can only be done at a small number of discrete locations along a pipeline. As a result, the sample size is extremely small and the confidence level of the findings in terms of being representative of the pipeline as a whole is very low. Internal data require the main to be shut down and dewatered for inspection. This is extremely costly due to the service interruption, which may require by-pass pumping or honey wagons to be used to transport the wastewater in the absence of upstream storage capacity.

As a result, little data are obtained on force main condition upon which assessment and subsequent rehabilitation decisions can be based. Rehabilitation decision-making can only be made on the basis of operational indicators such as power consumption, air release valve operation, or main breaks. The alternative is to consider consequence of failure and to renew high risk lines irrespective of any knowledge of their condition. This is inefficient and results in higher cost than either preventative maintenance or rehabilitation intervention based on condition assessment within a risk-based framework. The WERF report titled *Inspection Guidelines for Force Mains* addresses this issue (WERF, 2009). It sets out guidelines for inspection based on material. It also covers prioritization of inspections and the key considerations in the development of an inspection plan.

A key finding based on international experience reviewed is that utilities consider that there is benefit in being able to make a proactive decision on whether to renew based on risk. Part of this is to know where problems do not exist so expenditure can be deferred. The renewal decision is based on three elements: the rate of deterioration of assets; the condition of critical locations; and whether spending can be deferred. Risk analysis can also help indicate where the “wait and see” approach is most cost-effective. It is also important to take into account that inspection can create liabilities. Knowledge of a defect creates a need to do more than “wait and see.”

A first step is to establish risk-based assessment methods to identify force mains with serious consequences of failure, either in operational or environmental and public impact terms, or both. This will drive the need to understand the likelihood of failure and will identify the characteristics of force mains for which this information is needed. A second step is to consider prioritization for external data collection. A method for identifying high risk locations in terms of likelihood of failure based on environment and operating characteristics could pinpoint high risk locations, which would be selected for direct inspection. This would increase the chance that the small sample obtained would identify more critical conditions than otherwise.

There is a clear need for assessment methodologies that can work with limited data. These could potentially be based on Bayesian belief networks. There is also a need for inspection technologies that can provide data more cost-effectively to support these assessment methodologies. Development of clear maintenance guidelines, and linking of O&M data, for example cathodic protection system and power consumption data, to condition assessment is also necessary.

7.2 Capability Gaps

This section will address capability gaps in terms of rehabilitation technologies. The available rehabilitation technologies generally meet needs well. Despite being developed either for water mains or gravity sewers, they can readily be adapted for use in force mains. CIPP has a track record in force mains. The emergence of new CIPP systems based on woven fiberglass and UV-curing, which provides a much stronger liner with some hoop strength, also has applications in force mains. A gap exists in terms of a design procedure for CIPP in pressure applications to ensure that long-term performance requirements can be met.

The combination of tensile strain and potential chemical attack from wastewater can create strain corrosion problems in polymeric resin-based materials. This was a major problem for the early GRP pipes, under the name Techite, and there were several failures. The potential for strain corrosion in CIPP materials in pressure wastewater applications needs to be understood and taken into account in the design procedures developed.

Sliplining with PVC or HDPE also meets the needs in force mains, as does close-fit lining using either material. Non-structural methods, such as sprayed liners for internal corrosion protection are also equally well-adapted to force mains as they are to other pressure pipes provided that the materials used have adequate chemical resistance to wastewater and mechanical resistance to abrasion, which is more likely in force mains than in water mains.

The primary capability gaps are access needed to the main and the need to shut down, dewater, and clean the main for rehabilitation. This is an inevitable feature of any internal rehabilitation technology, as it is for inspection technologies. This also places a limitation on the use of rehabilitation in force mains. If the cost and disruption of by-pass pumping to open the main for access approaches that of replacement, and replacement leads to a longer remaining service life, a Net Present Value calculation may indicate that replacement is more cost-effective.

There is also a need for emergency repair procedures for lining systems and for utilities to be trained in their application. Lack of such procedures makes utilities reluctant to rehabilitate force mains, preferring replacement with materials for which they have emergency repair procedures in place.

7.3 Benefits, Costs, and Challenges in Closing Gaps

Based on the information gathered in this report, Table 7-1 summarizes the technology gaps and the potential costs and benefits associated with their closure.

Table 7-1. Technology Gaps and Closure Costs and Benefits

Gap	Close By	Benefit	Cost	Challenge
External data collection	Increase sample size	More reliable data	High	Technologies that provide wall thickness data over a long distance from a single point
External data collection	Target high risk locations	Find worst case. Prioritize	Medium	Develop screening method - use LPR
Internal data collection	Live insertion and working	Reduced cost of data	High	Live insertion and retrieval of existing tools
Risk-based assessment	Method for determining consequence of failure	Identify critical assets	Low	Transforming qualitative information into quantitative data for decision-making
Assessment with limited data	Bayesian belief networks	Assessment at lower data collection cost	Medium	Determining adequate level of data for model to be robust
Operation and maintenance for assessment	Integrated approach/database	More assessment data at low cost	Low	Obtaining and capturing relevant data
CIPP long-term performance in pressure wastewater application	Determining susceptibility to strain corrosion	Long-term confidence in CIPP rehabilitation	Medium	Test method to identify strain corrosion effect over long-term
CIPP pressure design	Develop/adopt procedure/method	Long-term confidence in CIPP rehabilitation	Low	Acceptance of method developed
Rehabilitation or replacement decision-making	Knowing total rehabilitation cost including by-pass pumping, compared with replacement cost	Improved decision-making on rehabilitation vs. replacement	Medium	Data for robust cost model
Emergency repair of rehabilitation systems	Develop procedures and train utility personnel	Remove reluctance of utilities to rehabilitate force mains	Medium	Rapid procedures that can be implemented by utility crews

8.0 FINDINGS AND RECOMMENDATIONS

Partly because of the difficulty in assessing the condition of sewer force mains, leaving a lot of owners with questions about the integrity of these critical assets, and the limited amount of rehabilitation technologies available for renewing a deteriorated main, there has not been a significant amount of renewal work in the past. Most of the renewal activity has been outright replacement of the force main, either by open cut or trenchless means. As the nation's force mains age further, greater emphasis will be placed on finding cost-effective ways to renew these critical assets. Fortunately, new products and technologies are now emerging for carrying out a direct condition assessment on a buried force main, as well as rehabilitation methods for those found in distress. Many of these rehabilitation methods originated in the gravity sewer market or water market, but have been adapted to meet the special needs of sewer force mains.

One method of assisting owners in their efforts to apply some of these emerging technologies will be in the publication of demonstration projects and case studies. Also, setting up a decision support system that helps a utility ask the right questions so that a viable rehabilitation solution emerges is paramount. Utilities also need to consider implementing maintenance programs that can demonstratively extend the useful life of their current mains, deferring the cost of renewal or replacement to a future date.

This section reviews a number of these subjects and offers suggestions for technologies that might be considered in some demonstration projects.

8.1 What Systems Would Benefit Most from Being Demonstrated in Field Settings?

Systems that would benefit from demonstration in field settings fall into two categories: data collection (inspection) systems and rehabilitation systems. The scope of this review is rehabilitation rather than inspection. Nevertheless, the demonstration of certain inspection systems was considered to be valuable because they can provide data that drive rehabilitation decisions. Referring to Table 7-1, the technologies for which field demonstration would yield greatest benefit would be the following:

- External data collection: Screening method to identify high risk locations. Potentially LPR or over line potential surveys.
- Internal data collection: Live insertion and retrieval of inspection tool. Pipe Diver (PPIC, Canada) for PCCP and See Snake for ferrous mains.
- Internal data collection: Acoustic technologies for leak detection and location of air pockets. Sahara[®] (PPIC, Canada) and SmartBall[®] (Pure Technologies, Canada).
- Internal lining: CIPP (nonwoven felt/polyester resin and woven fiberglass/UV-cured); sliplining (PVC and HDPE); and close-fit lining (PVC and HDPE).
- Structural spray-on lining with fast cure: polyurea-based material.

8.2 Key Parameters for Evaluation in Demonstration Projects

Table 8-1 identifies the key parameters to be evaluated in demonstration projects.

Table 8-1. Parameters for Evaluation in Demonstration Projects

Technology	Installation Parameters	Performance Parameters	Comments
LPR	Representative soil sample	Ability to identify high risk locations for external corrosion	Rate of corrosion
Pipe Diver	Live insertion and retrieval	Speed of operation. Impact on operation of main. Range of data collected	Cost of tapping. Saving in obviating by-pass pumping
Sahara [®]	Live insertion and retrieval	Size of leak detected. Identification of air pockets	None.
SmartBall [®]	Live insertion and retrieval	Size of leak detected. Identification of air pockets	None.
CIPP, Nonwoven felt + polyester resin	Size of openings. Speed of installation	Strain corrosion. Long-term performance under pressure. Abrasion resistance	Life-cycle costs. May need accelerated aging tests. Repair methods
CIPP, Woven fiberglass + UV-curing	Size of openings. Speed of installation	Strain corrosion. Long-term performance under pressure. Abrasion resistance	Life-cycle costs. May need accelerated aging tests. Repair methods
Sliplining PVC	Size of openings. Speed of installation. End fittings	Fatigue loading. Abrasion resistance	Life-cycle costs. Capacity effect of cross-section loss. Repair methods
Sliplining HDPE	Size of openings. Speed of installation. End fittings	Fatigue loading. Abrasion resistance	Life-cycle costs. Capacity effect of cross-section loss. Repair methods
Close-fit lining PVC	Size of openings. Speed of installation. End fittings	Fatigue loading. Abrasion resistance	Life-cycle costs. Repair methods
Close-fit lining HDPE	Size of openings. Speed of installation. End fittings	Fatigue loading. Abrasion resistance	Life-cycle costs. Repair methods

8.3 Guidance for Establishing a Comprehensive System Rehabilitation Program

Many questions remain unanswered and Tables 7-1 and 8-1 identify the key issues and what additional information is necessary. However, it is clear that a system rehabilitation program needs to integrate several aspects and to have a broader vision than merely the rehabilitation technology and its implementation.

The elements that need to be integrated, within the scope of an asset management approach, are: inspection; assessment; maintenance; and rehabilitation. These will support a decision-making process that ensures cost-effective maintenance of a desired service level for the force mains within a wastewater collection and conveyance system.

When this framework is established, decisions concerning individual elements of the program can be made. The scope of this report is rehabilitation so this section will focus on rehabilitation and not on the bigger picture. When rehabilitation has been identified as a potential solution, three questions must be answered in reaching a decision as to method:

- (1) What is necessary? (i.e., What problem is to be solved and what performance is required in service, including service life?)
- (2) What is feasible? (i.e., What methods can achieve the performance level identified as necessary?)
- (3) What is cost-effective? (i.e., Of the feasible options, which achieves the performance required at least cost, including alternatives such as replacement?)

When these decisions have been made, aspects such as material selection, testing, and QA can be developed and included in individual project specifications. The specifications should require test data or testing to be carried out to verify that the desired performance through the service life can be met. It should also set out a QA regime to ensure that the material and its installation conform to the specification requirements.

The type of specification used is also important. It may be prescriptive or performance-based. A prescriptive specification identifies what must be done and also how it must be achieved. A performance specification sets out what must be done and the required performance level, but leaves the “how” to the contractor. A prescriptive specification places greater risk on the owner whereas a performance specification shares risk more evenly between owner and contractor.

8.4 Guidance for Maintenance Programs

Maintenance also comes under an asset management plan and framework and contributes to cost-effective operation of force mains through their service life. Often poor or non-existent maintenance is a contributory factor in the need for rehabilitation, so development and implementation of efficient maintenance can reduce or delay the need for rehabilitation or replacement of a main, with significant financial benefit.

The key elements of force main maintenance are: regular cleaning; maintenance of cathodic protection systems; and maintenance of air release valves. Operational indicators such as power consumption and frequency and volume of air release valve operation can identify when and where maintenance is required. Linking these indicators to a maintenance program will make it more cost-effective. Using maintenance data can also contribute to condition assessment and decisions on timing of rehabilitation or replacement of force mains.

8.5 Sound, Risk-Based, Decision-Making Process Development

This also falls into the area of asset management. Overall system risk may be defined as the risk of failing to achieve the service level desired. Each element in the system contributes to this risk. The likelihood of force main failure and the consequence for the system both need to be known to assess risk and to prioritize assessment and intervention in a cost-effective manner. If consequence of failure is low, there is little value in knowing likelihood because it has no impact on decisions made or actions taken. Therefore, the first step is to identify critical assets for which consequence of failure is high. When this is done, it becomes necessary to identify the likelihood of failure for assets where the consequence of failure is above a certain threshold. Inspection and condition assessment of the assets support this effort. The level of likelihood of failure identified from inspection and assessment then drives management of the asset, comprising maintenance, operation (possibly actions such as reducing operating pressure), and rehabilitation or replacement. This management approach is designed to maintain risk at an acceptable level as defined in an asset management plan.

8.6 Cost-Effectiveness of Decision-Making Processes

The decision-making process relies on data from inspection to assess risk levels and to decide on necessary actions. Determining the level of data or information required to support effective decisions is a key aspect of the process. Too little data and the wrong decisions may be made; too much data and the cost of obtaining the data may exceed its value in the process. Neither scenario is cost-effective.

In general, more information leads to better decisions. But this leads to a quest for perfect information to eliminate risk from the decisions to be made. This is not cost-effective. Decision-making processes that can be effective with limited information are necessary. Bayesian belief networks provide one platform for such processes. In addition, these processes need to be combined with expertise, experience, knowledge, and engineering judgment if they are to be robust and reliable, while also mitigating risk. For this reason, “black box” processes that can be blindly followed by non-specialists are high risk processes with the potential for overlooking unusual conditions or contributing factors to risk.

A key element in the decision-making process as to the method of rehabilitation chosen is the degree of deterioration present in the force main. The differences in the design of a liner designed for a partially deteriorated main versus a fully deteriorated main can be substantial. When insufficient data are available to make that distinction, owners tend to err on the conservative side and chose a solution appropriate for a fully deteriorated asset. More cost-effective solutions are eliminated from the decision-making process as a result of such actions.

8.7 Timing for Rehabilitation Action

One element not addressed in this report is the determination of when is the most appropriate time for a rehabilitation action to be implemented on an asset class. This report alludes to the “end of life” of an asset as the point where rehabilitation is required. The “end of life” can be defined in several different ways (Rose, 2009):

- End of Physical Life – pipe actually fails (collapses)
- End of Service Life – pipe no longer performs at level required by stakeholders (e.g. customers and regulators)
- End of Economic Life – pipe in its current management and operating environment ceases to be the lowest cost alternative to satisfy a specified level of performance or service at an acceptable level of risk

These limits are reached at different points in time, usually with end of service life (driven by customer complaints) reached before physical or economic end of life is achieved. However, most condition assessment activities are focused on the determination of the end of the physical life of the asset, while it is the end of service life or economic life that drives reinvestment.

One of the key decisions a utility manager has to make is when to rehabilitate an asset from an economic and service life standpoint. Answering this question is beyond the scope of this report, but is vital to the asset management of a sewer force main system. This topic will be addressed in a later research report, which is devoted to decision-making support systems for replacement versus rehabilitation.

8.8 Demonstration/Verification of Pressure System Rehabilitation

The need at this stage is to demonstrate or verify elements of pressure system rehabilitation. Tables 7-1 and 8-1 set out the needs and the specific elements to verify. All of these are contributors to the development of an integrated asset management program for the force main element of wastewater systems. Their verification will enable methodologies and protocols for comprehensive system rehabilitation programs to be developed that are robust, efficient, and cost-effective. A combination of demonstration projects to verify capabilities and closing gaps in data and knowledge is essential to support development of the necessary tools for force main rehabilitation programs. Programs that allow an owner to reasonably predict the remaining life of a force main that has been renewed with a liner is paramount.

9.0 REFERENCES

- Aggarwal, S.C. and M.J. Cooper. 1984. *External Pressure Testing of Insituform Linings*. Internal Report. Coventry Polytechnic.
- American Society Civil Engineers (ASCE). 2005. *Pipeline Design for Installation by Horizontal Directional Drilling*, Manual & Reports on Engineering Practice No. 108, Ruston, VA.
- American Water Works Association (AWWA). 2001. *Rehabilitation of Water Mains, Manual of Water Supply Practices M28*, Denver, CO.
- American Water Works Association Research Foundation (AWWARF). 2003. *Investigation of Pipe Cleaning Methods*, Denver, CO.
- U.S. Environmental Protection Agency (EPA). 2007. *Innovation and Research for Water Infrastructure for the 21st Century Research Plan*. Office of Research and Development, National Risk Management Research Laboratory. April 30.
- Newman, A.E. 2000. *Ferrocement & Laminated Cementitious Composites*, Techno Press 3000, Ann Arbor, MI, 372p.
- Office of Water Service (OFWAT). 2005. *Water & Sewerage Service Unit Costs and Relative Efficiency, 2003-2004 Report*, Jan. 2005, 114p.
- Plastic Pipe Institute (PPI). 2009. "PPI PVC Range Composition Listing Of Qualified Ingredients," PPI TR-2/2009(a), PPI, Washington, D.C. 2009.
- Simicevic, J. and R. Sterling. 2003. *Survey of Bid Prices for Trenchless Methods*, Report and MS Access 2000 Database, Trenchless Technology Center, Louisiana Tech University, Ruston, LA, 77p.
- Rose, D. 2009. Private email correspondence.
- Thomson J., R. Morrison, and E. Spivak. 2006. *The Investigation, Assessment, and Design of a Rehabilitation Solution*, WEFTEC Conference Dallas, TX.
- Water Environment Research Foundation (WERF). 2009. *Guidelines for the Inspection of Force Mains* (Draft). 04-CTS-6UR. Alexandria, VA.

APPENDIX A
RENEWAL TECHNOLOGIES DATASHEETS

Technology/Method	Spray On Lining/Polyurethane
I. Technology Background	
Status	Conventional
Date of Introduction	Formally known as Copon Hycote 169HB by E.Wood Inc. A preceding product Copon Hycote 169 was introduced in the UK in 1999. A succeeding product 3M Scotchkote Spray-in-Place Pipe 269 (which is a polyurea formulation) is slated for introduction in the US in 2009.
Utilization Rates	Actively being used in UK and Canada. About 200 miles have been lined, the bulk of which is in UK.
Vendor Name(s)	3M Scotchkote 169HB 3M Corrosion Protection Products Division Austin, Texas Phone: 512-984-5515 Fax: 512-984-4871 Web: http://www.3m.com/ Email: gsnatwig@mmm.com
Practitioner(s)	Derrick Horsman Alltech Solutions, Canada Email: dhorsman@alltechsolutions.ca Peter Oram AECOM, US Email: e.peter.oram@m-e.aecom.com
Description of Main Features	Copon Hycote 169HB is a two component coating specifically designed for use in pipeline applications and is available as a grey finish. The material has a low viscosity to allow for pumping to remote spray heads and is moisture tolerant to provide high-build slump resistant coatings with improved adhesion characteristics. Finished coatings are hard, glossy and free of surface tack or greasiness. This rapid setting polymeric lining offers a semi-structural spray lining alternative to conventional replacement technologies without the large scale disruption generally associated with replacement.
Main Benefits Claimed	<ul style="list-style-type: none"> • No large scale disruption compared to PE slip lining • Excellent abrasion resistance. • Long-term corrosion protection material • Equivalent to AWWA M28 Class 3 Rehabilitation technology. • Usually bypass service is not required. • Approved under UK Regulation 31(4)(a) of the Water Supply (Water Quality) Regulations. • Recommended for pipes prone to local damage and well suited for local host pipe damage. • Easier leakage detection on metal pipes.
Main Limitations Cited	<ul style="list-style-type: none"> • Not recommended for pipe with residual asset life less than 30 years • Not recommended for use in PVC pipe because of failure pattern in host pipes
Applicability (Underline those that apply)	Force Main <u>Gravity Sewer</u> <u>Laterals</u> <u>Manholes</u> <u>Appurtenances</u> <u>Water Main</u> <u>Service Lines</u> Other: Oil, Gas and Industrial pipelines
II. Technology Parameters	
Service Application	Rehabilitation by spray lining
Service Connections	Fully-bonded along pipe thereby requires no secondary fittings
Structural Rating Claimed	Tensile Stress at yield is 14.2 MPa Tension Modulus is 600 MPa Flexure Modulus is 770 MPa * LC8 standards clearance
Materials of Composition	Polyurethane <ul style="list-style-type: none"> • Base Component: White thixotropic liquid • Activator Component: Black thixotropic liquid • Mixed Material: Light Grey
Diameter Range, inches	>= 4

Technology/Method	Spray On Lining/Polyurethane
Thickness Range, inches	<ul style="list-style-type: none"> Film Thickness of 80 mils is recommended under NSF 61 listing. Practical applications of 120 to 200 mils are achieved. Actual lining thickness is at the discretion of the utility thickness.
Pressure Capacity, psi	At 3 mm coating thickness, 145 psi for 100 mm pipe diameter. *Capacity changes with material thickness and pipe diameter
Temperature Range, °C	To be stored in the original sealed containers at temperatures between 0°C and 40°C. Copon Hycote 169 HB shall not be applied when substrate/water temperatures are less than 3°C. Material temperature at the application head is 25-35°C.
Renewal Length, feet	575 feet
Other Notes	<ul style="list-style-type: none"> Adhesion performance is 10.2 MPa Approved manufacturing facility is in North Yorkshire, UK
III. Technology Design, Installation, and QA/QC Information	
Product Standards	NSF 61 approved DWI approved - UK Norwegian, Spanish, and Polish Approvals also available
Design Standards	Equipment needs special head and cleaning.
Design Life Range	30+ years. Some studies suggest 40-60 years.
Installation Standards	<ul style="list-style-type: none"> Number of Coats: 1 Maximum Thinner: None Cure Time: 30 minutes at 30°C Special Comments: Mix ratio of A:B is 2.5:1. One hour flush required prior to being placed into service.
Installation Methodology	<ul style="list-style-type: none"> Linings of 1-5 mm thickness may be applied in a single pass of the application head. Cleaning, drying and joint-filling are required. One excavation required for every 100–150 m approximately. Same day return to service for every 100–150 m renewal length. Disruption for around 8 hours. Recommended deflection in pipe of up to 12 degrees. CCTV inspection of the coating may be carried out after a minimum cure period of 10 minutes from completion of lining. The coating shall be allowed to cure for a minimum period of 60 minutes after completion of lining before the commencement of disinfection and flushing procedures.
QA/QC	<ul style="list-style-type: none"> Principles of Water Supply Hygiene and Technical Guidance Notes Effective control of a BS EN ISO 9000 Quality System In-Situ Rapid Setting Polymeric Lining Operational Guidelines and Code of Practice: Published by Warren Associates (Pipelines) Ltd Material Safety Data Sheet
IV. Operation and Maintenance Requirements	
O&M Needs	Using a maximum of not more than 100 mg/L of free chlorine
Repair Requirements for Rehabilitated Sections	Leakage detection tests, recoating
V. Costs	
Key Cost Factors	Lesser storage space required, reduced number of pit excavations, universal item product and does not vary for different pipe diameters, all soil to be treated as contaminated waste, allows use of existing pipe rather than exhuming it, smaller carbon footprint, does not affect external pipe condition, small number of resources amounting to reduced contractor risk, lesser time for installation site, tarmac coating required at excavation pits. Contribution to material costs includes the lining material, equipment, and use of existing pipe.
Case Study Costs	Approximately 60 Euros in urban areas (2006)
VI. Data Sources	
References	<ul style="list-style-type: none"> http://solutions.3m.com/wps/portal/3M/en_US/Corrosion/Protection/Product

Technology/Method	Spray On Lining/Polyurethane
	<p data-bbox="581 212 1352 275">s/Catalog/?PC=7_RJH9U52300NAF02J1MHGK22C53_nid=QF308SF96Fbe9JQFPTCN6Zgl</p> <ul data-bbox="548 279 1352 449" style="list-style-type: none"><li data-bbox="548 279 1352 342">• http://www.nsf.com/Certified/PwsComponents/Listings.asp?Company=00190&Standard=061<li data-bbox="548 346 831 378">• Alltech Magazine article<li data-bbox="548 382 1274 449">• Pipeline Rehabilitation Worldwide: Copon Hycote 169HB Technical Guidance Note

Technology/Method	Spray on Lining/Polyurea
I. Technology Background	
Status	Emerging
Date of Introduction	3M Water Infrastructure just introduced Scotchkote Spray-In-Place Pipe (SIPP) 269 Coating at the ASCE Pipeline 2009 conference in San Diego. The original formulation developed by E. Wood, known as Copon Hycote 169HB was a polyurethane and not capable of meeting the NSF 61 standard, according to 3M representatives.
Utilization Rates	The original Copon Hycote 169HB is actively being used in the UK and Canada. About 200 miles have been lined, bulk of which is in UK. The new Scotchkote SIPP 269 has no known uses as of the time of this report.
Vendor Name(s)	Scotchkote Spray-In-Place Pipe (SIPP) 269 Coating 3M Water Infrastructure 3M Center, Building 223-02-S-24 St. Paul, MN 55144-1000 Phone: 512-984-5515 Fax: 512-984-4871 Web: http://www.3m.com/water Email: gnsatwig@mmm.com
Practitioner(s)	Not available
Description of Main Features	Scotchkote SIPP 269 is a two component coating specifically designed for use in pipeline applications and is available as a grey finish. The material has low viscosity characteristics for pumping to remote spray head locations and is moisture tolerant to provide high build slump resistant coatings with strong adhesion characteristics. The gel time at 68°F is 120 seconds, cure time for CCTV inspection is 10 minutes, and ready for return to service in 60 minutes. It is made of 100% solids and has no VOCs. Based on the material properties, all of which are short term values, this polyurea coating will primarily be suitable as an inner corrosion barrier or a semi-structural (Class II) liner. The low elastic modulus means the liner will act as an interactive liner and be dependent on the host pipe to carry the internal pressure.
Main Benefits Claimed	<ul style="list-style-type: none"> • Approved to NSF/ANSI Standard 61 as certified by WQA and NSF • Contains no VOCs per EPA method 8260 • Quick cure allows CCTV inspection immediately after application (10 minutes) • Same day return to service, bypass service not required. • Can be applied to pipes 4 to 50 inches in diameter • Typically will not plug service connections
Main Limitations Cited	<ul style="list-style-type: none"> • Material property data is all based on short-term testing • Material appears to be very flexible with low tensile strength, which will limit its use for semi or fully structural rehabilitation.
Applicability (Underline those that apply)	<u>Force Main</u> <u>Gravity Sewer</u> <u>Laterals</u> Manholes Appurtenances <u>Water Main</u> Service Lines Other: Oil, Gas and Industrial pipelines
II. Technology Parameters	
Service Application	Rehabilitation by spray lining
Service Connections	Fully bonded along pipe thereby requires no secondary fittings
Structural Rating Claimed	Tensile Strength: 16 MPa (2,320 psi) Flexural Strength: 22 MPa (3,190 psi) Flexural Modulus: 720 MPa (104,400 psi)
Materials of Composition	Polyurea <ul style="list-style-type: none"> • Base Component: White thixotropic liquid • Activator Component: Black thixotropic liquid • Mixed Material: Light Grey
Diameter Range, inches	4-50 inches
Thickness Range, inches	<ul style="list-style-type: none"> • Film target thickness is 140 mils (3.5 mm). • Practical applications of 120 to 200 mils are achieved.

Technology/Method	Spray on Lining/Polyurea
	<ul style="list-style-type: none"> Actual lining thickness is at the discretion of the utility thickness.
Pressure Capacity, psi	No information on bridging capability available.
Temperature Range, °F	<ul style="list-style-type: none"> To be stored in the original sealed containers at temperatures between 32°F (0°C) and 86°F (30°C).
Renewal Length, feet	575 feet
Other Notes	
III. Technology Design, Installation, and QA/QC Information	
Product Standards	NSF 61 approved DWI approved - UK Norwegian, Spanish, and Polish approvals also available
Design Standards	Equipment needs special head and cleaning.
Design Life Range	30+ years, some studies suggest 40-60 years.
Installation Standards	<ul style="list-style-type: none"> Number of Coats: 1 Cure Time: 10 minutes at 86°F (20°C) Special Comments: Mix ratio of A:B is 1:1 by volume. One hour flush required prior to being placed into service.
Installation Methodology	<ul style="list-style-type: none"> Linings of 1mm – 5 mm thickness may be applied in a single pass of the application head. Cleaning, drying and joint-filling are required. 1 excavation required for every 100-150 m approximately. Same day return to service for every 100-150 m renewal length. Disruption for less than 8 hours. CCTV inspection of the coating may be carried out after a minimum cure period of 10 minutes from completion of lining. The coating shall be allowed to cure for a minimum period of 60 minutes after completion of lining before the commencement of disinfection and flushing procedures.
QA/QC	<ol style="list-style-type: none"> Principles of Water Supply Hygiene and Technical Guidance Notes Effective control of a BS EN ISO 9000 Quality System In-Situ Rapid Setting Polymeric Lining Operational Guidelines and Code of Practice: Published by Warren Associates (Pipelines) Ltd Material Safety Data
IV. Operation and Maintenance Requirements	
O&M Needs	Using a maximum of not more than 100 mg/L of free chlorine
Repair Requirements for Rehabilitated Sections	Leakage detection tests, recoating
V. Costs	
Key Cost Factors	Lesser storage space required, reduced number of pit excavations, universal item product and does not vary for different pipe diameters, all soil to be treated as contaminated waste, allows use of existing pipe rather than exhuming it, smaller carbon footprint, does not affect external pipe condition, small number of resources amounting to reduced contractor risk, lesser time for installation site, tarmac coating required at excavation pits. Contribution to material costs includes the lining material, equipment, and use of existing pipe.
Case Study Costs	Representative coverage rate for 8 inches diameter pipe is 0.2 gallons/foot
VI. Data Sources	
References	www.3M.com/water

Technology/Method	Close Fit/Tension Based, Symmetrical Reduction
I. Technology Background	
Status	Conventional
Date of Introduction	Late 1980s
Utilization Rates	Over 1,000 miles (1,600 km) of Swagelining have been installed to date.
Vendor Name(s)	Swagelining Suite 100 600 Bent Creek Boulevard Mechanicsburg PA 17050 USA Phone: 717-724-1900 Fax: 717-724-1901 Web: http://www.swagelining.com Email: info.us@advanticagroup.com
Practitioner(s)	Licenses provided on website.
Description of Main Features	<ul style="list-style-type: none"> The Swagelining system uses polyethylene pipe, which has an outside diameter slightly larger than the inside diameter of the pipe to be lined. After sections of PE are fused together to form a continuous pipe, the PE pipe is pulled through a reduction die, which temporarily reduces its diameter. This allows the PE pipe to be pulled through the existing pipeline. After the PE pipe has been pulled completely through the pipe, the pulling force is removed and the PE pipe returns toward its original diameter until it presses tightly against the inside wall of the host pipe. Swagelining is suitable for the rehabilitation of all types of pressure pipe.
Main Benefits Claimed	<ul style="list-style-type: none"> When the host pipe is structurally sound, the wall thickness of the liner may be reduced. Since sections of PE pipe are butt fused together, there are no joints where leaks could develop in the future. Compact, lightweight equipment requires very little setup time resulting in less disruption, faster installation, and less expense. It is capable of installing the full range of PE pipe quickly and easily in cast iron, ductile iron, steel, concrete and asbestos cement pipelines. There is no shrinkage or curing and no field chemistry or heating is required. Polyethylene is flexible, leak tight, and highly resistant to chemical attack.
Main Limitations Cited	<ul style="list-style-type: none"> Tension must be maintained on the string of pipe until full insertion is completed. Work site requires room for a long string of butt-fused pipe sections to be strung out before diameter reduction
Applicability (Underline those that apply)	<u>Force Main</u> <u>Water Main</u> <u>Forced Sewer</u> Other: <u>Gas</u> , <u>Water Injection Lines</u> , <u>Mining Slurry</u> and any other services using metallic pipe.
II. Technology Parameters	
Service Application	Rehabilitation and replacement
Service Connections	Standard fittings are available to allow sections of PE-lined pipe to be easily and securely reconnected to the rest of your water transmission or distribution system. Wide variety of PE pipes and a full complement of tapping, branching, and connection methods have been developed to provide a total renewal system.
Structural Rating Claimed	This depends on the PE pipe rating as well as whether or not the PE is to be used as a liner or a replacement for the existing pipe.
Materials of Composition	Polyethylene
Diameter Range, inches	4-44 inches
Thickness Range, inches	DR 11 to 42
Pressure Capacity, psi	This depends on the PE pipe rating as well as whether or not the PE is to be used as a liner or a replacement for the existing pipe.
Temperature Range, °F	Pressure derating is required for temperatures above 80°F up to 100°F. The manufacture to be consulted for temperatures above 100°F.

Technology/Method	Close Fit/Tension Based, Symmetrical Reduction
Renewal Length, feet	Up to 3,000 feet between excavations.
Other Notes	Not Available
III. Technology Design, Installation, and QA/QC Information	
Product Standards	PE pipe is approved for potable water service in most countries, and can be specified to withstand a wide range of internal pressures and burial depths
Design Standards	PE pipes used in the Swagelining process are manufactured to ISO, AGA, ASTIVI, and API standards, so lines renewed by this process have known physical properties and an established service life.
Design Life Range	As per specification of PE pipe used.
Installation Standards	As per client specifications.
Installation Methodology	As per sliplining, but the PE pipe is pulled through a die prior to being pulled through the host pipe.
QA/QC	Not available
IV. Operation and Maintenance Requirements	
O&M Needs	Resistant to corrosion, abrasion, and ground movement.
Repair Requirements for Rehabilitated Sections	Standard as PE pipe is used.
V. Costs	
Key Cost Factors	Social & economic cost of open cut replacement versus trenchless rehabilitation of existing pipe lines. List of parameters or key drivers for the costs. Labor, transport, PE prices & delivery, joints (price & delivery), mobilization, pit excavation, cleaning, inspection, gauging, lining, testing, re-connection, site restoration.
Case Study Costs	Not available
VI. Data Sources	
References	http://www.gl-group.com/en/is/8816.php http://www.advanticagroup.com/default.aspx?page=594 http://www.gl-group.com/pdf/Swagelining_DS.pdf Communication with Richard Hempson.

Technology/Method		Close Fit PE/Symmetrical Reduction
I. Technology Background		
Status	Conventional	
Date of Introduction	1985 introduced into the US	
Utilization Rates	8,000 miles of Tite Liner installed.	
Vendor Name(s)	Tite Liner® United Pipeline Systems (Division of Insituform Technologies) 135 Turner Drive Durango, CO 81301 Phone: 970-259-0354 Fax: 970-259-0356 Web: www.insituform.com	
Practitioner(s)	Not available.	
Description of Main Features	The liner pipe is custom sized so that the OD is larger than the ID of the host pipe. The pipe is butt-fused together to the desired length. A roller reduction unit is placed at the insertion end, while a winch is placed at the other. The winch pulls the fusion welded liner through the roller reduction unit, which radially compresses the liner OD during the insertion. Once the liner pipe is completely through the section to be lined, the tension is released and the Tite Liner expands radially to fit inside the host pipe.	
Main Benefits Claimed	<ul style="list-style-type: none"> • Resistant to many fluids • Structural capability to bridge holes and gaps • Minimal diameter reduction • Low coefficient of friction • Minimal site disruption • Long section lengths • Low cost 	
Main Limitations Cited	<ul style="list-style-type: none"> • Must be continuous installation without interruption • HDPE liner thin wall • Surface damage to HDPE liner during installation • Interactive – host pipe must have sufficient structural strength to carry internal and external loads 	
Applicability (Underline those that apply)	<u>Force Main</u> Gravity Sewer Laterals Manholes Appurtenances <u>Water Main</u> Service Lines Other: <u>Oil and Gas</u>	
II. Technology Parameters		
Service Application	Corrosion protection and abrasion resistance to steel pipes in the oil and gas, mining, and chemical industries. Leak stoppage for water and wastewater lines.	
Service Connections	Not available.	
Structural Rating Claimed	Class II or III, Semi-Structural	
Materials of Composition	HDPE PE3408 or PE4710	
Diameter Range, inches	2-52 inches	
Thickness Range, inches	Not available.	
Pressure Capacity, psi	Not available.	
Temperature Range, °F	Not available.	
Renewal Length, feet	Up to 2,600 feet	
Other Notes	Not available.	
III. Technology Design, Installation, and QA/QC Information		
Product Standards	NSF 61 Listing (for potable water applications)	
Design Standards	Not available.	
Design Life Range	Not available.	
Installation Standards	Not available.	
Installation Methodology	See above description of main features for installation process.	
QA/QC	Not available.	

Technology/Method	Close Fit PE/Symmetrical Reduction
IV. Operation and Maintenance Requirements	
O&M Needs	Not available.
Repair Requirements for Rehabilitated Sections	Not available.
V. Costs	
Key Cost Factors	Not available.
Case Study Costs	Not available.
VI. Data Sources	
References	www.insituform.com

Technology/Method	
Symmetrical Reduction PE Close Fit Liner	
I. Technology Background	
Status	Emerging
Date of Introduction	2001 in US
Utilization Rates	Total HDPE experience worldwide - over 8000 miles.
Vendor Name(s)	InsituGuard™ Flexed HDPE Insituform Technologies, Inc 17999 Edison Avenue Chesterfield, MO 63005 Phone: 800-234-2992 Fax: 636-519-8744 Web: http://www.insituform.com/
Practitioner(s)	Not available
Description of Main Features	Inserted into a new or existing pipeline, the polyethylene liner is continuous, and installed with a close-fit against the inner wall of the host pipe. The polyethylene liner isolates the flow stream from the host pipe wall, eliminating internal corrosion. InsituGuard stops leaks, and can provide a fully structural solution in some cases.
Main Benefits Claimed	<ul style="list-style-type: none"> • Rapid installation • Drinking water approved • Negotiates long radius (sweep) bends • Utilizes high-performance PE 100 (4710) • Minimizes disruption
Main Limitations Cited	<ul style="list-style-type: none"> • Cannot do factory bends (20% diameter reduction to facilitate introduction) • Bypass required
Applicability (Underline those that apply)	<u>Force Main</u> Gravity Sewer Laterals Manholes Appurtenances <u>Water Main</u> Service Lines Other: _____
II. Technology Parameters	
Service Application	Rehabilitation
Service Connections	Service Connections have to be excavated. Fused fittings used to reinstate.
Structural Rating Claimed	Class 3 or 4 depending upon diameter, pressure and host pipe condition.
Materials of Composition	4710 (PE 100)
Diameter Range, inches	6 to 48 inches
Thickness Range, inches	DR 17 or thinner
Pressure Capacity, psi	Pressure rating to 150+ psi for Class 3. Class 4 dependent upon DR.
Temperature Range, °F	140°F
Renewal Length, feet	2000+ feet depending on winching capacity.
Other Notes	Pipes may be cleaned, as needed, with high-pressure water jet cleaners, mechanically powered equipment, and winch cable attached devices or fluid-propelled pig devices.
III. Technology Design, Installation, and QA/QC Information	
Product Standards	HDPE is certified as complying with ANSI NSF Standard 61.
Design Standards	Class 4 design based on AWWA/PPI design standards. Class 3 interactive design based on industry accepted design methodology.
Design Life Range	50 years
Installation Methodology	<ol style="list-style-type: none"> 1. Excavations are required for installation and to remove any existing fittings. 2. The PE pipe selected for the project is welded into lengths suitable for installation; this can be the entire length, or shorter segments to accommodate available work space. If shorter segments are used, they will be fused together prior to entering the roller reduction machine. 3. The welded pipe is pushed through the roller box, which alters the shape of the pipe, resulting in a diameter reduction of up to 20% of the cross-sectional area. 4. The liner is inserted into the host pipe. 5. Once the liner is in place, it is cut to length, end fittings are attached and the liner is pressurized to snap the bands. 6. Intermediate fittings are installed, service connections are excavated and

Technology/Method	Symmetrical Reduction PE Close Fit Liner
	reconnected, and the completed line is pressure tested, disinfected and returned to service. Access points are backfilled and reinstated.
QA/QC	<ul style="list-style-type: none"> • Prior to installation of InsituGuard, CCTV inspection of the main is needed to locate any obstructions, protrusion, changes in diameter or in-line valves that could affect the InsituGuard. • After installation, InsituGuard is inspected again visually with CCTV, and any abnormalities are noted. • For the post-installation pressure test, InsituGuard is subjected to an internal pressure equal to twice the known operating pressure, or operating pressure plus 50 psi, whichever is less. • After a stabilization period, the test period is one hour. Limit on make-up water to maintain pressure is 20 gallons per inch diameter per mile of pipe per day.
IV. Operation and Maintenance Requirements	
O&M Needs	Before returning the InsituGuard to service, for potable water, the system shall be disinfected in accordance with local standards.
Repair Requirements for Rehabilitated Sections	Excavate, remove the damaged portion of InsituGuard and host pipe (if necessary), install end couplers and bridge the previously damaged location with new pipe and couplers as required.
V. Costs	
Key Cost Factors	The most costly material is the pipe.
Case Study Costs	Not available
VI. Data Sources	
References	http://www.insituform.com/default.aspx http://www.insituform.com/content/309/insituguard---pressure-pipe.aspx http://www.insituform.com/content/312/polyflex_installation.aspx

Technology/Method	Rolldown/Close Fit PE Liner Symmetrical Reduction
I. Technology Background	
Status	Emerging
Date of Introduction	Not available.
Utilization Rates	Not available.
Vendor Name(s)	Rolldown Subterra Daniels Contractors Ltd Lyncastle Way Appleton Thorn Warrington WA4 4ST UK Phone: +44 (0)1925 860666 Email: info@subterra.co.uk Web: www.subterra.co.uk
Practitioner(s)	Not available.
Description of Main Features	Rolldown is a close fit polyethylene lining. Standard grade (PE80) PE is pushed through a series of concentric rollers reducing the diameter to facilitate placement inside a deteriorated host pipe. After insertion, the liner is pressurized with water at ambient temperature to revert to its original size.
Main Benefits Claimed	<ul style="list-style-type: none"> • Negotiate bends up to 11.25° • Designed to be fully structural (full pressure) or just a thin wall liner that bridges over holes and gaps • PE holds its reduced diameter indefinitely prior to reversion, allows stop/start internal corrosion • Minimal loss of cross-sectional area and therefore capacity
Main Limitations Cited	<ul style="list-style-type: none"> • Custom extruded PE with OD to match host pipe ID
Applicability (Underline those that apply)	<u>Force Main</u> Gravity Sewer Laterals Manholes Appurtenances <u>Water Main</u> Service Lines Other: <u>Gas transmission and distribution</u>
II. Technology Parameters	
Service Application	Water Supply and Distribution, Sewer Pumping Mains
Service Connections	Reinstate via excavation
Structural Rating Claimed	Fully structural (IV) or Semi-Structural (II)
Materials of Composition	PE 80
Diameter Range, inches	4-20 inches (100-500mm)
Thickness Range, inches	Not available.
Pressure Capacity, psi	232 psi (16 bar)
Temperature Range, °F	73°F (pressure derating required at higher temperatures)
Renewal Length, feet	5,000 feet (1,500 meters) in one insertion
Other Notes	Not available.
III. Technology Design, Installation, and QA/QC Information	
Product Standards	NSF 61 Certified (for potable water applications)
Design Standards	Not available.
Design Life Range	50 years
Installation Standards	Not available.
Installation Methodology	PE pipe is custom extruded with OD matching ID of host pipe. The host pipe is cleaned, removing any internal corrosion or deposits. The integrity of the host pipe should be checked via CCTV. At site, the string of PE pipe is butt-fused together and then pushed through a series of concentric rollers, which reduces the diameter of the liner pipe allowing it to be pulled through the host pipe. Insertion lengths of up to 5,000 feet are possible. The reduced diameter PE pipe maintains its diameter until subjected to internal water pressure. The internal pressure reverts the pipe back to its original diameter and in close contact with the host pipe. The string of PE pipes can be pulled through a bend of up to 11.25°. Standard couplings are then attached to the end of the exposed pipe sections and make-up pieces are inserted to reconnect the pipe to the existing main.

Technology/Method	Rolldown/Close Fit PE Liner Symmetrical Reduction
QA/QC	CCTV the line, after cleaning, to make sure there are no impediments to prevent insertion and reversion of the PE liner.
IV. Operation and Maintenance Requirements	
O&M Needs	Not available.
Repair Requirements for Rehabilitated Sections	Not available.
V. Costs	
Key Cost Factors	Not available.
Case Study Costs	Not available.
VI. Data Sources	
References	www.subterra.co.uk , Rolldown flyer

Technology/Method	Subcoil/Close Fit PE Liner Fold and Form
I. Technology Background	
Status	Emerging
Date of Introduction	Not available.
Utilization Rates	Not available.
Vendor Name(s)	Subcoil Subterra Daniels Contractors Ltd Lyncastle Way Appleton Thorn Warrington WA4 4ST UK Phone: +44 (0)1925 860666 Email: info@subterra.co.uk Web: www.subterra.co.uk
Practitioner(s)	Not available.
Description of Main Features	Subcoil is a close fit polyethylene lining that is factory folded and held in a “C” shape. Subcoil arrives on a large spool. After insertion, the liner is pressurized with water at ambient temperature breaking the temporary bands and reverting the pipe back to its original dimensions and forming a close fit with the host pipe.
Main Benefits Claimed	<ul style="list-style-type: none"> • Negotiate bends up to 22.5° • Designed to be a thin wall liner that bridges over holes and gaps preventing leakage • Stops internal corrosion • Minimal lost of cross-sectional area and therefore capacity
Main Limitations Cited	<ul style="list-style-type: none"> • Custom extruded PE with OD to match host pipe ID • Proprietary end fittings needed to join the liner up to the existing main
Applicability (Underline those that apply)	<u>Force Main</u> Gravity Sewer Laterals Manholes Appurtenances <u>Water Main</u> Service Lines Other: <u>Gas transmission and distribution</u>
II. Technology Parameters	
Service Application	Water Supply and Distribution, Sewer Pumping Mains
Service Connections	Reinstate via excavation using proprietary fittings
Structural Rating Claimed	Semi-Structural (II)
Materials of Composition	PE 80
Diameter Range, inches	4-12 inches (95-300mm)
Thickness Range, inches	Not available.
Pressure Capacity, psi	Depends on size of hole being bridged
Temperature Range, °F	73°F (pressure derating required at higher temperatures)
Renewal Length, feet	3,500 feet (1,000 meters) in one insertion
Other Notes	Not available.
III. Technology Design, Installation, and QA/QC Information	
Product Standards	NSF 61 Certified (for potable water applications)
Design Standards	Not available.
Design Life Range	50 years
Installation Standards	Not available.
Installation Methodology	PE pipe is custom extruded with OD matching ID of host pipe. The host pipe is cleaned, removing any internal corrosion or deposits. The integrity of the host pipe should be checked via CCTV. The spool of PE is pulled through the host pipe. Insertion lengths of up to 3,500 feet are possible. The reduced cross-section PE pipe maintains its shape until subjected to internal water pressure. The internal pressure breaks the restraining straps and reverts the pipe back to its original diameter and in close contact with the host pipe. The string of PE pipes can be pulled through a bend of up to 22.5°. Proprietary couplings are then attached to the end of the exposed pipe sections and make-up pieces are inserted to reconnect the pipe to the existing main.

Technology/Method	Subcoil/Close Fit PE Liner Fold and Form
QA/QC	CCTV the line (after cleaning) to make sure there are no impediments to prevent insertion and reversion of the PE liner. Pressure test after insertion.
IV. Operation and Maintenance Requirements	
O&M Needs	Not available.
Repair Requirements for Rehabilitated Sections	Not available.
V. Costs	
Key Cost Factors	Not available.
Case Study Costs	Not available.
VI. Data Sources	
References	www.subterra.co.uk

Technology/Method	PE Liner/ Cement Mortar Bonded Interactive Composite Liner
I. Technology Background	
Status	Innovative
Date of Introduction	UK market in 1999 and US market in 2006
Utilization Rates	MainSaver is a new product technology with approximately 5,000 feet installed in the US. Annual installations are expected to increase from about 5,000 feet per year to 20,000+ feet per year.
Vendor Name(s)	MainSaver® MainSaver 1819 Denver West Drive, Suite 100 Golden, CO 80401 Phone: 303-277-8603 Fax: 303-277-0042 Web: www.mainsaverworld.com Email: info@mainsaverworld.com
Practitioner(s)	MainSaver has been installed in several municipal water systems in the Rocky Mountain region, including several high profile linings (two under Interstate 25, approximately 3,300 feet in neighborhoods, and a school fire line restoration) for the City of Thornton, Colorado. City of Thornton 12450 Washington Street Thornton, CO 80241-2405 Contact: Mr. Jason Pierce, P.E. 720-977-6274
Description of Main Features	MainSaver is a flexible MDPE tube with integral grout key hooks on the outside surface, which is inserted into the main, then a pre-determined quantity of proprietary cement grout is placed between the outside of the tube and the inside of the host pipe. Air pressure is used to move a rounding swab along the length of the liner, which progressively expands the tube and distributes the grout against the interior surface of the host pipe, physically filling all pipe defects. MainSaver is used to renew pipes with holes, displaced joints, leaking joints, offsets of no more than 12.5% of each joint and maximum 22° long radius elbows. It is NSF 61 certified for use with potable water.
Main Benefits Claimed	<ul style="list-style-type: none"> • Simple system, easy to install • Low installation cost • Suitable for use with all types of pipes, particularly ferrous, asbestos-cement, reinforced concrete, and pre-stressed concrete cylinder pipe. • Cement provides active corrosion protection (ferrous mains) and the PE tube ensures water quality • Prevents leakage • Service connections can be reinstated robotically to reduce excavation requirements.
Main Limitations Cited	<ul style="list-style-type: none"> • Ideal installation temperature range is between 40°F and 80°F, although MainSaver has specific hot and cold weather installation procedures. • Designed for pressure pipes only. • Unsuitable for lining through diameter changes
Applicability (Underline those that apply)	<u>Force Main</u> Gravity Sewer Laterals Manholes Appurtenances <u>Water Main</u> Service Lines Other:
II. Technology Parameters	
Service Application	Potable water, raw water and force mains
Service Connections	MainSaver uses its RoboTap™ method for remote robotic service connection reinstatement after the MainSaver composite has been installed. This eliminates the need to excavate the main to reinstate service connections.
Structural Rating Claimed	Class III, Interactive and Semi-Structural Liner
Materials of	Medium density polyethylene, cement mortar (Masterflow® 1515 PipeSaver)

Technology/Method	PE Liner/ Cement Mortar Bonded Interactive Composite Liner
Composition	
Diameter Range, inches	4 inches to 12 inches
Thickness Range, inches	Approximately 3/16 inches (3.0 mm). However, grout will often be thicker where it is filling pipe defects.
Pressure Capacity, psi	Max. hole size of 2.4 inches or gap of 0.4 inches with pressure up to 294 psi (20 bar)
Temperature Range, °F	Min. 37°F during installation
Renewal Length, feet	Approximately 500 feet
Other Notes	All installed materials are ANSI/NSF 61 certified for contact with potable water. Cathodic protection can be restored to ferrous pipes to retard external corrosion.
III. Technology Design, Installation, and QA/QC Information	
Product Standards	NSF 61 listed
Design Standards	None cited.
Design Life Range	If properly installed, a 50+ year design life for the liner would be reasonable.
Installation Standards	None cited.
Installation Methodology	Main must be thoroughly cleaned and CCTV inspected. Robotically plug any open service connections where unwanted grout may migrate. Tube liner is winched into main. At end where grout is to be introduced, fit grout injection fitting to main. Trim other end of liner and install tensioning and anti-twist assembly. Grout slug is pumped into the grout fitting and the rounding swab is advanced down length of lining run to distribute the mortar around the outside of the liner. The liner is held under very low air pressure in order to allow the grout to hydrate for up to 16 hours. Once the grout is hydrated, the lining is inspected using CCTV and infrared thermography. MainSaver's RoboTap is used to remotely, robotically reinstate the service connections, and PE end seals are installed to protect the new liner as it is returned to service. The pipe is disinfected (if potable water).
QA/QC	MainSaver/W.S.U.'s Quality Management System is certified to ISO 9001:2000 for the Custom Manufacture of NSF Standard 61 Extruded Tape and In-situ Remediation of Potable Water Lines. The host main is cleaned and CCTV inspected prior to lining, and post-lining the installation is CCTV and IRTV (infrared) inspected to verify grout distribution behind the liner.
IV. Operation and Maintenance Requirements	
O&M Needs	No special maintenance needs. PE liner is smooth and should maintain low frictional resistance.
Repair Requirements for Rehabilitated Sections	If a lined section needs to be repaired, the MainSaver composite liner can be cut out with the damaged pipe section and conventionally patched with a spool piece.
V. Costs	
Key Cost Factors	Set up costs (key cost drivers) are generally dependent upon mobilization logistics, traffic control requirements, trench backfilling requirements, and asphalt and concrete replacement. Material costs are constant. The main variable is the amount of material required.
Case Study Costs	MainSaver's installation costs are competitive with cement mortar lining, less expensive than CIPP rehabilitation, and less expensive than conventional pipeline replacement.
VI. Data Sources	
References	MainSaver Web site and brochure. MainSaver will provide third party test data and results to interested parties upon request.

Technology/Method	Subline/Close Fit PE Liner Fold and Form
I. Technology Background	
Status	Emerging
Date of Introduction	Not available.
Utilization Rates	Not available.
Vendor Name(s)	Subline Subterra Daniels Contractors Ltd Lynceastle Way Appleton Thorn Warrington WA4 4ST UK Phone: +44 (0)1925 860666 Email: info@subterra.co.uk Web: www.subterra.co.uk
Practitioner(s)	Consolidated Edison, Inc. Bronx and Manhattan 1200 feet of 30 inches and 600 feet of 36 inches cast iron lined with Subline. 760mm Subline had an SDR of 32.5 and the 910 mm Subline an SDR of 60.
Description of Main Features	Subline is a close fit polyethylene lining. Pre-welded standard grade PE (PE80) is pushed through a former that folds it into a “C” shape that is temporarily maintained by restraining bands. After insertion, the liner is pressurized with water at ambient temperature breaking the temporary bands and reverting the pipe back to its original dimensions.
Main Benefits Claimed	<ul style="list-style-type: none"> • Negotiate bends up to 45° • Designed to be a thin wall liner that bridges over holes and gaps preventing leakage • Stops internal corrosion • Minimal lost of cross-sectional area and therefore capacity
Main Limitations Cited	<ul style="list-style-type: none"> • Custom extruded PE with OD to match host pipe ID • Proprietary couplings needed to join the liner up to the existing main
Applicability (Underline those that apply)	<u>Force Main</u> Gravity Sewer Laterals Manholes Appurtenances <u>Water Main</u> Service Lines Other: <u>Gas transmission and distribution</u>
II. Technology Parameters	
Service Application	Water Supply and Distribution, Sewer Pumping Mains
Service Connections	Reinstate via excavation using proprietary fittings
Structural Rating Claimed	Semi-Structural (II)
Materials of Composition	PE 80
Diameter Range, inches	3-60 inches (75-1,600 mm)
Thickness Range, inches	0.12-0.80 inches (3-20 mm)
Pressure Capacity, psi	Depends on size of hole being bridged
Temperature Range, °F	73°F (pressure derating required at higher temperatures)
Renewal Length, feet	3,500 feet (1,000 m) in one insertion
Other Notes	Include specific notes here such as water quality, I/I control, other
III. Technology Design, Installation, and QA/QC Information	
Product Standards	NSF 61 Certified (for potable water applications)
Design Standards	Not available.
Design Life Range	50 years
Installation Standards	Not available.
Installation Methodology	PE pipe is custom extruded with OD matching ID of host pipe. The host pipe is cleaned, removing any internal corrosion or deposits. The integrity of the host pipe should be checked via CCTV. At site, the string of PE pipe is butt-fused together and then pushed through a former that folds the pipe into a “C” shape allowing it to be pulled through the host pipe. The pipe is temporarily strapped to

Technology/Method	Subline/Close Fit PE Liner Fold and Form
	maintain the reduced shape through insertion. Insertion lengths of up to 3,500 feet are possible. The reduced cross-section PE pipe maintains its shape until subjected to internal water pressure. The internal pressure breaks the restraining straps and reverts the pipe back to its original diameter and in close contact with the host pipe. The string of PE pipes can be pulled through a bend of up to 45°. Proprietary couplings are then attached to the end of the exposed pipe sections and make-up pieces are inserted to reconnect the pipe to the existing main.
QA/QC	CCTV the line, after cleaning, to make sure there are no impediments to prevent insertion and reversion of the PE liner. Pressure test after insertion.
IV. Operation and Maintenance Requirements	
O&M Needs	Not available.
Repair Requirements for Rehabilitated Sections	Not available.
V. Costs	
Key Cost Factors	Not available.
Case Study Costs	Not available.
VI. Data Sources	
References	www.subterra.co.uk , Subline flyer

Technology/Method		Fold and Form PE Close Fit Liner	
I. Technology Background			
Status	Emerging		
Date of Introduction	2001 in US		
Utilization Rates	Total HDPE experience worldwide – over 8,000 miles. Folded HDPE worldwide experience – approximately 6 miles.		
Vendor Name(s)	InsituGuard™ Folded HDPE Insituform Technologies, Inc 17999 Edison Avenue Chesterfield, MO 63005 Phone: 800-234-2992 Fax: 636-519-8744 Web: http://www.insituform.com/		
Practitioner(s)	1,000 feet of 19-24 inches Steven Tusler City of Colorado Springs 121 S. Tejon Colorado Springs, CO 80947 719-668-8537 19,000 feet of 30 inches Mr. Dick Fett IMC Agrico Company Mulberry, Florida 863-648-9990 3,700 feet of 36 inches Mr. Howard Wellspring City of Baytown, TX 2123 Market St Baytown, TX 77522 713-424-5508		
Description of Main Features	Inserted into a new or existing pipeline, the polyethylene liner is continuous, and installed with a close-fit against the inner wall of the host pipe. The polyethylene liner isolates the flow stream from the host pipe wall, eliminating internal corrosion. InsituGuard stops leaks, and can provide a fully structural solution in some cases.		
Main Benefits Claimed	<ul style="list-style-type: none"> • Rapid installation - 40% reduction in diameter • Drinking water approved • Negotiates long radius (sweep) bends • Utilizes high-performance PE 100 (4710) 		
Main Limitations Cited	<ul style="list-style-type: none"> • Cannot do factory bends • Bypass required • Wall thickness limitation dependent upon diameter. 		
Applicability (Underline those that apply)	<u>Force Main</u> Gravity Sewer Laterals Manholes Appurtenances <u>Water Main</u> Service Lines Other: _____		
II. Technology Parameters			
Service Application	Rehabilitation		
Service Connections	Service Connections have to be excavated. Fused fittings used to reinstate.		
Structural Rating Claimed	Class 3 or 4 depending upon diameter, pressure and host pipe condition.		
Materials of Composition	4710 (PE 100)		
Diameter Range, inches	12-48 inches		
Thickness Range, inches	DR 17 or thinner		
Pressure Capacity, psi	Pressure rating to 150+ psi for Class 3. Class 4 dependent upon DR.		
Temperature Range, °F	Temperature derating required for temperatures over 80°F. Max temp is 140°F		

Technology/Method	Fold and Form PE Close Fit Liner
Renewal Length, feet	2,000+ feet depending on winching capacity.
Other Notes	Pipes may be cleaned, as needed, with high-pressure water jet cleaners, mechanically powered equipment, and winch cable attached devices or fluid-propelled pig devices.
III. Technology Design, Installation, and QA/QC Information	
Product Standards	HDPE is certified as complying with ANSI NSF Standard 61.
Design Standards	Class 4 design based on AWWA/PPI design standards. Class 3 interactive design based on industry accepted design methodology.
Design Life Range	50 years
Installation Methodology	<ol style="list-style-type: none"> 1. Excavations are required for installation and to remove any existing fittings. 2. The PE pipe selected for the project is welded into lengths suitable for installation; this can be the entire length, or shorter segments to accommodate available work space. If shorter segments are used, they will be fused together prior to entering the folding machine. 3. The welded pipe is pushed through the folding machine, which alters the shape of the pipe, resulting in a diameter reduction of up to 40% of the cross-sectional area. The shape is maintained by banding the folded pipe. 4. The liner is inserted into the host pipe. 5. Once the liner is in place, it is cut to length, end fittings are attached and liner is pressurized to snap the bands. 6. Intermediate fittings are installed, service connections are excavated and reconnected, and the completed line is pressure tested, disinfected and returned to service. Access points are backfilled and reinstated.
QA/QC	<ul style="list-style-type: none"> • Prior to installation of InsituGuard, CCTV inspection of the main is needed to locate any obstructions, protrusion, changes in diameter or in-line valves that could affect the InsituGuard. • After installation, InsituGuard is inspected again visually with CCTV, and any abnormalities are noted. • For the post-installation pressure test, InsituGuard is subjected to an internal pressure equal to twice the known operating pressure, or operating pressure plus 50 psi, whichever is less. After a stabilization period, the test period is one hour. Limit on make-up water to maintain pressure is 20 gallons per inch diameter per mile of pipe per day.
IV. Operation and Maintenance Requirements	
O&M Needs	Before returning the InsituGuard to service, for potable water, the system shall be disinfected in accordance with local standards.
Repair Requirements for Rehabilitated Sections	Excavate, remove the damaged portion of InsituGuard and host pipe (if necessary), install end couplers and bridge the previously damaged location with new pipe and couplers as required.
V. Costs	
Key Cost Factors	The most costly material is the pipe.
Case Study Costs	Not available
VI. Data Sources	
References	http://www.insituform.com/default.aspx

Technology/Method	Fold and Form/Thermoformed
I. Technology Background	
Status	Conventional
Date of Introduction	1994
Utilization Rates	Over 4.5 million feet installed since 1994. Split fairly evenly between 4 to 16 inches and 18 to 30 inches pipeliner installations. As of 2008, PVC Alloy Pipeliner has been installed in 36 states, and 2 international countries, with over \$20 million dollars worth of PVC Alloy Pipeliner contracts completed annually. Listed for use by at least 30 State DOT's.
Vendor Name(s)	Ultraliner PVC Alloy Pipeliner™ Ultraliner, Inc. 201 Snow Street/PO Drawer 3630 Oxford, AL 36203 Phone: 256-831-5515 Fax: 256-831-5575 Website: www.ultraliner.com Email: info@ultraliner.com
Practitioner(s)	Georgia Department of Transportation (GDOT) – District One Ken Reed, District Bridge Maintenance Manager 2505 Athens Hwy SE P.O. Box 1057 Gainesville, Georgia 30503-1057 City of Los Angeles, California Keith Hanks 650 S. Spring St., Room 1000 Los Angeles, CA 90014 Phone: 213- 847-8770 Jacksonville Naval Air Station [1] Bill Myer, the Navy's airfield facility manager for both NAS Jacksonville and the Outlying Field [OLF] of the White House Phone: 904- 542-3176 Email: bill.meyer@navy.mil
Description of Main Features	Ultraliner PVC Alloy Pipeliner is a solid wall PVC pipe manufactured from virgin PVC homopolymer resin with no fillers, which is modified with special additives to improve ductility and toughness. The pipeliner is collapsed flat and coiled on a reel in continuous, jointless lengths. Small diameters, 12 inches and less, are folded in the field prior to insertion, while large diameters, 15 inches and above, are deflected to a smaller profile (approx. 50%) at the manufacturing facility.
Main Benefits Claimed	<ul style="list-style-type: none"> • Conforms to size transitions, tight bends, offset joints and other irregularities. • Does not shift/shrink longitudinally or radially after installation (memory reset by heat and stretching to new dimensions); consistently achieves a tight fit. • Able to withstand significant shallow impact loads. • Reliable flanged and gasketed end seals in pressure applications and hydrophilic gasket end seals in gravity applications. • The solid wall PVC alloy cuts and polishes smoothly and quickly without jagged edges at lateral reconnections. • Very high abrasion resistance and ductility. • PVC alloys are chemically compatible with any sewerage application where a traditional direct burial PVC pipe would be appropriate. • Factory controlled consistency of design properties including modulus, wall thickness, and corrosion resistance enhances long-term asset manageability [2], [3]. • Low mobilization, shipping, and set-up costs make for exceptional competitiveness in rural, DOT, and smaller scale projects.

Technology/Method	Fold and Form/Thermoformed
	<ul style="list-style-type: none"> Relatively small job site footprint. Most equipment can be parked away from the insertion access if necessary.
Main Limitations Cited	<ul style="list-style-type: none"> Materials are NSF 61 approved, but system has yet to be listed for use in potable water lines; listing is planned to be pursued in the future. Limited long-term pressure test data to support independent use as a fully structural liner in pressure applications; available data supplemented by 10 years of practical field application. Requires access at both ends of the pipe for installation. Requires excavation for a pressure seal at branch connections. All tight-fitting liners require additional technologies (grout packing, lateral lining, or other) to provide a seal at internal branch connections. Elevated temperatures lower the modulus of thermoplastics like PVC alloys, thus modulus adjustments should be considered within the structural equations when the application is significantly above routine wastewater flow temperatures. Construction network is small scale which limits available economies of scale and influences potential competitiveness on larger scale projects (particularly 30,000 linear feet +). Not currently available in most major metros. This is subject to change with coverage expansion.
Applicability (Underline those that apply)	<u>Force Main</u> <u>Gravity Sewer</u> Laterals Manholes Appurtenances Water Main <u>Service Lines</u> Other: <u>Culverts, Industrial, Water Intake</u>
II. Technology Parameters	
Service Application	Wastewater, storm water, raw water, industrial, power
Service Connections	Laterals remotely reinstated with robots. Down time 5 hours plus time to reinstate laterals. Sewer main flow typically disrupted for 3 to 4 hours.
Structural Rating Claimed	Fully structural, independent liner. Flexural modulus available as 145,000 psi (F1871) or 280,000 psi (F1504), and flexural strength as 4,100 psi (F1871) or 5,000 psi (F1504). Design is determined by industry standard equations with material properties adjusted for long-term performance under load.
Materials of Composition	Virgin PVC alloy compound (impact modified, no fillers, NSF approved)
Diameter Range, inches	4 to 30 inches – F1504 only to 16 inches
Thickness Range, inches	4 inches – DR 32.5, 6, 8, 9 inches – DR 32.5 to 35, 10, 12, 15, 16 inches – DR 32.5 to 41, 18 inches – DR 35 to 50, 21, 24, 30 inches – generally designated by wall thickness up to 0.65 inches
Pressure Capacity, psi	Currently available for low pressure, under 80 psi (only available up to 15 inches diameter pipe). Design methodologies are still being researched, with no available standards. Have completed one “experimental” 150 psi project.
Temperature Range, °F	100°F (continuous) for F1871; 120°F for F1504; intermittent and diluted flows at higher temps may be acceptable. Under sustained elevated temperatures, the design modulus needs to be adjusted for structural calculations.
Renewal Length, feet	Up to 600 feet typical; 1,000 feet for 8 to 12 inches has been achieved, and up to 650 feet for 21 inches and 24 inches, up to 500 feet for 30 inches
Other Notes	Minimal to no loss of flow capacity expected; flow velocity increases can be significant. No noxious or toxic chemicals (NSF potable water and FDA food contact safe materials). Safe for use in environmentally sensitive applications. Has evidenced comparable I/I control to competitive alternatives in field applications.
III. Technology Design, Installation, and QA/QC Information	
Product Standards	ASTM F-1871 Standard Specification for Folded/Formed Poly (Vinyl Chloride) Pipe Type A for Existing Sewer and Conduit Rehabilitation ASTM F-1504 Standard Specification for Folded Poly (Vinyl Chloride) (PVC) Pipe for Existing Sewer and Conduit Rehabilitation
Design Standards	Appendix within ASTM installation standard F1867 and F1947 is the same as that within ASTM F1216 for CIPP products.

Technology/Method	Fold and Form/Thermoformed
Design Life Range	100 year claimed [4],[5], but not field-demonstrated; long-term material data testing and creep strain analysis offered as evidence of claim.
Installation Standards	ASTM F1867 ASTM F1947
Installation Methodology	The Ultraliner PVC Alloy pipeliner is pulled into the cleaned host pipe, usually through a manhole. Access is required at both ends. Once in place, the ends are plugged and the pipeliner expanded with steam and air pressure (thermoformed) to reset the PVC Alloy's "memory" to the new size and shape. Installation and processing of the liner takes 4 to 5 hours, excluding the time to reinstate laterals and some street operations set-up and tear down time.
QA/QC	Design material properties are quality assured at the manufacturing facility per ASTM product standards (F1871 or F1504) using industry standard QA/QC protocols common to the manufacture of all PVC pipes. Specification compliance is confirmed prior to installation. Standard industry post-construction QA/QC tests are available for further verification.
IV. Operation and Maintenance Requirements	
O&M Needs	No special maintenance training is required. Any cleaning or de-rooting procedure routinely practiced by maintenance personnel within PVC pipes is safe for use within PVC Alloy pipeliners. The host pipe can easily be removed (hammer a rigid host pipe to shatter it) without damaging the pipeliner, if new connections or repairs need to be made in the future. Standard fittings, couplings, and saddles are readily adaptable for use with PVC Alloy Pipeliners.
Repair Requirements for Rehabilitated Sections	PVC Alloy pipeliners are capable of structurally lining and conforming to crushed sections of pipe and severe off-sets. Repair decisions are therefore generally driven by system performance and long-term O&M requirements rather than constructability limitations.
V. Costs	
Key Cost Factors	<p>PVC Alloy Pipeliners have relatively low set-up, mobilization, and shipping & handling costs. Materials are shelf-stable (do not have to be temperature controlled) and can be affordably shipped one reel at a time or in bulk (thereby enabling payment for stored materials where appropriate).</p> <ul style="list-style-type: none"> • Extensive cleaning of the host pipe, above and beyond what is considered a routine pipe maintenance cleaning project, is required for all tight-fitting liners. • On gravity pipes, no excavation is required, providing significant savings. Access can be achieved through a manhole ring on one end and at least a clean-out on the other end. Laterals are robotically reinstated internally. • Pressure pipes frequently require excavation at the ends (and in the middle where maximum lengths have been exceeded), at valves and hydrants, and at connections. This can significantly impact cost-competitiveness against alternative technologies that can avoid excavation. • De-watering is not required for quality assurance, as water exposure cannot alter design property compliance of a solid wall PVC Alloy Pipeliner, but it may be utilized for risk control, as appropriate, since excessive groundwater can narrow the window of installability. • The material cost is all inclusive (and includes manufacturing QA/QC) with no additional on-site mixing of chemicals, nor "finishing" labor requirements prior to installation. • End seals, when specified, are routinely included in the unit price for the pipeliner. • Lateral reinstatements are generally a separate cost because the numbers of connections vary. • PVC Alloy pipeliners tend to be more competitive on small scale (short lengths, small diameter) projects given low mobilization and set up costs compared to other trenchless rehab methodologies.
Case Study Costs	GDOT- seven deteriorated culverts, ranging in diameter from 15 inches to 30 inches and 40 to 80 feet in length were lined for a total cost of \$43,288. This was 34% less than the bid price of \$65,674 to dig-and-replace. Generally speaking,

Technology/Method	Fold and Form/Thermoformed
	<p>large scale (25,000 feet +) 8 inches PVC Alloy pipeliner projects can receive bids in the \$22 per feet range, whereas smaller scale 8 inches projects with significant mobilization requirements or especially challenging conditions can receive prices up into the approximately \$40 per feet range.</p>
<p>VI. Data Sources</p>	
<p>References</p>	<p>Ultraliner PVC Alloy Pipeliner™ brochure Private correspondence with Grant Whittle, VP of Ultraliner.</p> <p>[1] Whittle L. G. (2008). Takes Off at Naval Air Station in Jacksonville, Fla. Trenchless Technology Magazine, November, 2008.</p> <p>[2] Whittle L. G. and W. Zhao (2009). The Need for and Benefits of a Minimum Wall Thickness Requirement for Pipeliners. No Dig International 2009, Toronto, Canada, March 29 – April 3. Paper Accepted.</p> <p>[3] Zhao W. and L. G. Whittle (2009). An Asset Management Definition of Pipe Rehabilitation Success or Failure. ASCE Pipeline International 2009, San Diego, CA, Aug 16-19. Abstract Accepted.</p> <p>[4] Zhao W. and L. G. Whittle (2008). Long-term Performance life Prediction Using Critical Buckling Strain. NASTT No-dig 2008, Dallas, TX, April 27-May 2.</p> <p>[5] Zhao W. and L. G. Whittle (2008). Plastic Pipeliner Long-term Design: How to Accommodate Creep? ASCE Pipeline International 2008, Atlanta, GA, July 22-27.</p>

Technology/Method	Fold and Form PVC/ Thermoformed									
I. Technology Background										
Status	Conventional									
Date of Introduction	1999									
Utilization Rates	200 miles in the past 10 years.									
Vendor Name(s)	EX Pipe Miller Pipeline P.O. Box 34141 Indianapolis, IN 46234 Phone: 800-428-3742 Email: info@millerpipeline.com									
Practitioner(s)	City of Plano – Over 200,000 LF Installed Steve Spencer P.O. Box 860358 Plano, Texas 75086 972-769-4140 Anne Arundel Co, MD – Over 130,000 LF Installed Lew Addison 504 Baltimore Annapolis Blvd. Severna Park, MD 21146 410-647-2727 Collier County, FL – Over 100,000 LF Installed Steve Nagy 6027 Shirley St. Naples, FL 34109 239-591-0186									
Description of Main Features	EX Pipe is a high strength, un-plasticized PVC manufactured in a factory environment, meeting ASTM F1504. The EX Pipe material is softened with heat and continuously inserted into the host pipe via manholes or other access points. After insertion, the pipe is then expanded approximately 10% to fit tightly within the host pipe.									
Main Benefits Claimed	<ul style="list-style-type: none"> • Resistant to chemicals and abrasion • Stops water infiltration and exfiltration, root intrusion and soil loss • Smooth pipe finish improves flow characteristics • Cost to install EX Pipe is much less than conventional trenching techniques • No styrene odors • Low coefficient of thermal expansion means service cut-outs will not move • Can be installed in lines with 90° bends and small diameter changes 									
Main Limitations Cited	<ul style="list-style-type: none"> • Only available in diameters 6 to 15 inches • Installation by Miller Pipeline only • Minimal reduction in cross-section • No long-term pressure or tensile testing to substantiate a hydrostatic design basis for pressure use 									
Applicability (Underline those that apply)	<u>Force Main</u> <u>Gravity Sewer</u> Laterals Manholes Appurtenances Water Main <u>Service Lines</u> Other:									
II. Technology Parameters										
Service Application	Not available.									
Service Connections	Sewer laterals reinstated with robotic cutter and CCTV. No information on use of EX Pipe for low pressure applications.									
Structural Rating Claimed	Not available.									
Materials of Composition	EX Pipe is made from a base PVC, conforming to ASTM D1784, cell classification 12334B. The following are physical properties of EX Pipe: <table border="1" style="margin-left: auto; margin-right: auto;"> <thead> <tr> <th></th> <th>Test Method</th> <th>Value</th> </tr> </thead> <tbody> <tr> <td>Flexural Modulus, psi</td> <td>ASTM D790</td> <td>340,000</td> </tr> <tr> <td>Flexural Strength, psi</td> <td>ASTM D790</td> <td>9,000</td> </tr> </tbody> </table>		Test Method	Value	Flexural Modulus, psi	ASTM D790	340,000	Flexural Strength, psi	ASTM D790	9,000
	Test Method	Value								
Flexural Modulus, psi	ASTM D790	340,000								
Flexural Strength, psi	ASTM D790	9,000								

Technology/Method	Fold and Form PVC/ Thermoformed
	Tensile Strength, psi ASTM D638 6,000 Coeff. Of Thermal Expansion, in/in/°F 3.0 x 10 ⁻⁵ Long-term reduction of flexural modulus for creep 50%
Diameter Range, inches	6-15 inches
Thickness Range, inches	0.20-0.43 inches
Pressure Capacity, psi	Not available
Temperature Range, °F	140°F
Renewal Length, feet	6 inches – 600 feet, 8 inches – 580 feet, 10 inches – 425 feet, 12 inches – 425 feet, 15 inches – 350 feet
Other Notes	No NSF 61 listing so not approved for potable water.
III. Technology Design, Installation, and QA/QC Information	
Product Standards	ASTM F1504
Design Standards	ASTM F1947, Appendix X1 (same as F1216)
Design Life Range	50 year
Installation Standards	ASTM F1947
Installation Methodology	Existing pipe is first cleaned and CCTV. Protruding service connections are removed, and partially collapsed sections repaired (open cut). The EX Pipe is heated in the pipe warmer trailer to soften the PVC. Once softened, the EX Pipe is winched through the host pipe. Once in place, steam and pressure are applied to expand the PVC tightly against the host pipe. Steam is then replaced with air, while maintaining a constant pressure and the PVC is cooled to 100°F. After cooling, the PVC is trimmed at each pipe end. If for gravity sewer, house service connections are reopened using robotic cutting devices combined with a CCTV.
QA/QC	The line undergoes CCTV after installation. A section of pipe (“coupon”) is removed from each run of pipe for independent testing. Testing should include flexural and tensile properties, as a minimum.
IV. Operation and Maintenance Requirements	
O&M Needs	Same as PVC Pipe
Repair Requirements for Rehabilitated Sections	Same as PVC Pipe
V. Costs	
Key Cost Factors	<ul style="list-style-type: none"> • Avg. length of line per setup • Number of laterals to be reconnected • On 12-15 inches by-pass pumping can become a cost factor • Heavy cleaning or protruding tap removal • Limited easement access • Point repairs of collapsed or partially collapsed pipe
Case Study Costs	\$20-\$45/feet depending on size and quantities
VI. Data Sources	
References	www.millerpipeline.com

Technology/Method		Fold and Form PVC/ Thermoformed																
I. Technology Background																		
Status	Conventional																	
Date of Introduction	1992																	
Utilization Rates	Over 100 miles for gravity sewer, no force mains																	
Vendor Name(s)	AM-Liner II® American Pipe & Plastics, Inc. PO Box 577 Binghamton, NY 13902 Phone: 607-775-4340 Email: ampipe@ampipe.com Website: www.amliner.com																	
Practitioner(s)	Not available.																	
Description of Main Features	AM-Liner II is manufactured from PVC specially formulated for pipeline rehabilitation. The AM-Liner II is pulled into the host pipe and thermoformed creating a seamless, jointless, solid wall PVC pipe that tightly conforms to the interior contours of the original host pipe.																	
Main Benefits Claimed	<ul style="list-style-type: none"> • Installation can be done in under 4 hours – minimizes by-pass pumping and traffic control • Liner is manufactured in a controlled environment, not in the field. • Installed only by trained licensed contractors. • PVC is resistant to all chemicals normally found in a sewer. • Smooth interior – low friction factor 																	
Main Limitations Cited	<ul style="list-style-type: none"> • No experience with pressure applications • Not cost competitive with CIPP in diameters over 12 inches 																	
Applicability (Underline those that apply)	<u>Force Main</u> <u>Gravity Sewer</u> Laterals Manholes Appurtenances Water Main Service Lines Other: <u>Culverts</u>																	
II. Technology Parameters																		
Service Application	Gravity wastewater and storm water																	
Service Connections	Laterals reinstated robotically. No pressure connections.																	
Structural Rating Claimed	Fully structural for gravity sewer. Not actively marketed for force mains.																	
Materials of Composition	PVC compound conforming to ASTM D 1784 Cell Classification 12111. The installed liner has the following minimum physical properties: <table border="1" style="margin-left: auto; margin-right: auto;"> <thead> <tr> <th></th> <th>Test Method</th> <th>Value</th> </tr> </thead> <tbody> <tr> <td>Tensile Strength, psi</td> <td>ASTM D638</td> <td>3,600</td> </tr> <tr> <td>Tensile Modulus, psi</td> <td>ASTM D638</td> <td>155,000</td> </tr> <tr> <td>Flexural Strength, psi</td> <td>ASTM D790</td> <td>4,100</td> </tr> <tr> <td>Flexural Modulus, psi</td> <td>ASTM D790</td> <td>145,000</td> </tr> </tbody> </table> <p>A 25% reduction used for long-term modulus.</p>				Test Method	Value	Tensile Strength, psi	ASTM D638	3,600	Tensile Modulus, psi	ASTM D638	155,000	Flexural Strength, psi	ASTM D790	4,100	Flexural Modulus, psi	ASTM D790	145,000
	Test Method	Value																
Tensile Strength, psi	ASTM D638	3,600																
Tensile Modulus, psi	ASTM D638	155,000																
Flexural Strength, psi	ASTM D790	4,100																
Flexural Modulus, psi	ASTM D790	145,000																
Diameter Range, inches	6-12 inches																	
Thickness Range, inches	0.0185 inches (SDR 32.5) to 0.462 inches (SDR 26)																	
Pressure Capacity, psi	Unknown.																	
Temperature Range, °F	Unknown.																	
Renewal Length, feet	1000 feet.																	
Other Notes	Not available.																	
III. Technology Design, Installation, and QA/QC Information																		
Product Standards	ASTM F1871, Standard Specification of Folded/Formed Poly (Vinyl Chloride) Pipe Type A for Existing Sewer and Conduit Rehabilitation																	
Design Standards	ASTM F1867, Appendix X1 (same as F1216)																	
Design Life Range	Not available.																	
Installation Standards	ASTM F1867, Standard Practice for Installation of Folded/Formed Poly (Vinyl Chloride) (PVC) Pipe Type A for Existing Sewer and Conduit Rehabilitation																	

Technology/Method	Fold and Form PVC/ Thermoformed
Installation Methodology	High pressure water jet and CCTV inspect the line before installing liner. Heat the coil of folded flat AM-Liner II in the trailer until it is flexible enough to uncoil and pull through the shaping device and into the host pipe. Shaping device located at entrance to host pipe, or alternatively on back of heating trailer. High pressure water hose from cleaning truck is connected to the water spray nozzle assembly on the shaping device. The liner is pulled from the reel, the end (3 feet) folded over, and holes drilled for attachment of the pulling cable. The liner is then winched through the shaping device, after flow of water to the spray nozzles is started. The liner is pulled until it arrives at the downstream pit (manhole) and is brought to street level. The liner is cut at street level at both ends, leaving several feet of extra liner for stress relief. Steam is applied to the liner from the upstream free end. The pressure in the liner is controlled with the release of steam at the downstream end. A temperature of 200°F is maintained for the predetermined length of time. The cooling process is begun by switching from steam to compressed air. The pressure is maintained for 30 minutes after the liner has cooled to 80°F. The pressure is released and the ends trimmed. The liner is CCTV inspected and service connections reinstated robotically.
QA/QC	Field samples collected per ASTM F1867, Section 7.3. Leakage test after cool down, and before reinstatement of connections.
IV. Operation and Maintenance Requirements	
O&M Needs	None identified.
Repair Requirements for Rehabilitated Sections	None identified.
V. Costs	
Key Cost Factors	Not available.
Case Study Costs	Not cost competitive with CIPP above 12"
VI. Data Sources	
References	AM-Liner Data Sheet, AM-Liner II General Specification (Aug. 16, 2005), AM-Liner Installation Procedure (10/05)

Technology/Method		Close Fit Lining/Expandable PVC
I. Technology Background		
Status	Conventional	
Date of Introduction	Not available	
Utilization Rates	Not available	
Vendor Name(s)	Duraliner™ expandable PVC pipe Underground Solutions, Inc. 229 Howes Run Road Sarver, PA 16055 Phone: 724-353-3000 Fax: 724-353-3020 Email: info@undergroundsolutions.com Web: www.undergroundsolutions.com	
Practitioner(s)	Not available	
Description of Main Features	Duraliner™ is a patented, fully structural pipe rehabilitation system. The piping system can handle a wide range of system operating pressures and restore or improve the flow capacity of the host pipe. Duraliner™ PVC provides a design-life of 100+ years. The end result is a brand new pipe within the existing pipe.	
Main Benefits Claimed	<ul style="list-style-type: none"> • It meets system operating pressures. • Fully structural “stand alone” system. • It is resistant to water disinfectant induced oxidation and resistant to hydrocarbon permeation. 	
Main Limitations Cited	Not available	
Applicability (Underline those that apply)	<u>Force Main</u> <u>Gravity Sewer</u> <u>Laterals</u> Manholes Appurtenances <u>Water Main</u> Service Lines Other: Fire protection systems , Industrial water lines	
II. Technology Parameters		
Service Application	Rehabilitation and Replacement	
Service Connections	<ul style="list-style-type: none"> • Duraliner™ is tapped with standard fittings and procedures. • Duraliner™ easily connects with standard fittings and valves. • Most common applications have Duraliner™ expanded to ductile iron (DI) outside diameters (OD), making standard PVC gasketed fittings compatible. • Duraliner™ may be tapped with the same tapping saddles used on conventional PVC. • When tapping Duraliner™ one should refer to the Uni-Bell PVC Pipe Association's guidance for tapping PVC. 	
Structural Rating Claimed	Not available	
Materials of Composition	PVC	
Diameter Range, inches	4-16 inches	
Thickness Range, inches	Not available	
Pressure Capacity, psi	150psi+	
Temperature Range, °F	Not available	
Renewal Length, feet	Not available	
Other Notes	The improved coefficient of friction offsets the reduction in internal area to maintain or improve flow.	
III. Technology Design, Installation, and QA/QC Information		
Product Standards	NSF 61 Certified Products meet all of the same current performance standards and health/safety issues as AWWA C900 and C905 PVC pipe	
Design Standards	It conforms to cell classification 12454 as defined in ASTM D1784, meets ANSI/AWWA C900 or ANSI/AWWA C905	
Design Life Range	100 Year Design Life	

Technology/Method	Close Fit Lining/Expandable PVC
Installation Standards	Not Available
Installation Methodology	<ul style="list-style-type: none"> • Minimal excavations are performed. • Duraliner™ is fused to length for the project. • Duraliner™ is expanded tightly against the interior walls of the host pipe. • Exposed ends of the Duraliner™ are expanded to standard fitting sizes. • The new Duraliner is cut to length and reconnected to system. • Fused Duraliner™ is inserted into cleaned, inspected host pipe.
QA/QC	Not available
IV. Operation and Maintenance Requirements	
O&M Needs	As Duraliner™ is expanded molecular reorientation increases its hydrostatic design basis. This works toward offsetting the DR increase from expansion in the pressure rating.
Repair Requirements for Rehabilitated Sections	Not available
V. Costs	
Key Cost Factors	Not available
Case Study Costs	Not available
VI. Data Sources	
References	Website for Underground Solutions Inc.

Technology/Method		CIPP/Pull In Place or Inversion
I. Technology Background		
Status	Conventional	
Date of Introduction	1986	
Utilization Rates	9 million feet installed from inception.	
Vendor Name(s)	Inliner® CIPP Inliner Technologies, LLC (a Layne Christensen company and subsidiary of Reynolds Inliner, LLC) 1468 West Hospital Rd. Paoli, Indiana 47454 Phone: 812-723-0704 Email: gyothers@inliner.net Web: www.inliner.net	
Practitioner(s)	Gwinnet County Storm Sewer Improvements 25,000 feet of CIPP, diameters 15 to 72 inches Gwinnet County Watershed Manager 684 Winder Highway Lawrenceville, GA 30045 Phone: 678-376-7068 Frank Matticola White Creek Project – Nashville, TN 90,000 feet of CIPP, 800 service lateral renewals – 41% I&I reduction CTE Engineers 220 Athens Way, Suite 200 Nashville, TN 37228 Phone: 615-244-8864 Charlie Brown	
Description of Main Features	Resin impregnated felt tube that can be either installed by the inversion method or pulled into place. The felt tube is made by Inliner Products, Inc (subsidiary) and sized to fit the host pipe, taking any bends and diameter transitions into consideration. Resin impregnation is usually done off-site in a controlled environment. The catalyzed resin impregnated tube can be stored for up to two weeks in a refrigerated environment. Isophthalic polyester, vinylester and epoxy resin systems can be accommodated. Inliner CIPP incorporates two patented features: StretchGuard™ and ResinGuard™	
Main Benefits Claimed	<ul style="list-style-type: none"> • No dig or limited excavation renewal • 40% to 50% less costly than traditional open cut replacement • Minimum 50 year service life 	
Main Limitations Cited	<ul style="list-style-type: none"> • No long-term pressure regression or tensile testing has been done 	
Applicability (Underline those that apply)	<u>Force Main</u> <u>Gravity Sewer</u> <u>Laterals</u> Manholes Appurtenances Water Main <u>Service Lines</u> Other:	
II. Technology Parameters		
Service Application	Gravity and Low Pressure Wastewater	
Service Connections	Small diameter laterals opened by remote cutter, large diameter by man entry. Pressure connections not accommodated.	
Structural Rating Claimed	Class II, III, or IV	
Materials of Composition	Inliner Technologies uses both isophthalic polyester resin, epoxy vinyl ester and “enhanced” polyesters. The enhanced resin is a filled isophthalic polyester. Inliner fills their isophthalic polyester resin with a variety of materials based on the application. The non-woven needled felt tube is made of polyester fibers. An outer layer of impermeable thermoplastic material (polyethylene or polyurethane) is used to protect the resin from water and contaminants. If using the pulled in place installation method, an inner calibration hose or removable bladder is used. The calibration hose is constructed of thin dry felt coated with an impermeable plastic membrane. The felt is saturated with excess resin in the	

Technology/Method	CIPP/Pull In Place or Inversion																		
	<p>pulled in place liner and becomes part of the finished liner. The removable bladder, a thermoplastic membrane, is used in short laterals and point repairs, where it is preferred to not cut the ends of the installed CIPP liner. The properties of the Inliner CIPP product are listed below depending on the type of resin used:</p> <table border="1"> <thead> <tr> <th></th> <th><u>Isophthalic</u></th> <th><u>Enhanced</u></th> </tr> </thead> <tbody> <tr> <td>Flexural Modulus, psi</td> <td>250,000-380,000</td> <td>400,000-450,000</td> </tr> <tr> <td>Flexural Strength, psi</td> <td>4,500-6,600</td> <td>4,500-7,000</td> </tr> <tr> <td>Tensile Modulus, psi</td> <td>290,000-360,000</td> <td>290,000-400,000</td> </tr> <tr> <td>Tensile Strength, psi</td> <td>3,000-6,000</td> <td>3,000-5,000</td> </tr> <tr> <td>Tensile Elongation, %</td> <td>1-3</td> <td>2-4</td> </tr> </tbody> </table>		<u>Isophthalic</u>	<u>Enhanced</u>	Flexural Modulus, psi	250,000-380,000	400,000-450,000	Flexural Strength, psi	4,500-6,600	4,500-7,000	Tensile Modulus, psi	290,000-360,000	290,000-400,000	Tensile Strength, psi	3,000-6,000	3,000-5,000	Tensile Elongation, %	1-3	2-4
	<u>Isophthalic</u>	<u>Enhanced</u>																	
Flexural Modulus, psi	250,000-380,000	400,000-450,000																	
Flexural Strength, psi	4,500-6,600	4,500-7,000																	
Tensile Modulus, psi	290,000-360,000	290,000-400,000																	
Tensile Strength, psi	3,000-6,000	3,000-5,000																	
Tensile Elongation, %	1-3	2-4																	
Diameter Range, inches	4-120 inches																		
Thickness Range, inches	0.12–2.4 inches (3-60mm)																		
Pressure Capacity, psi	Recommended < 60 psi operating pressure																		
Temperature Range, °F	Recommended for 140°F or less																		
Renewal Length, feet	Lengths from 5 feet to 2400 feet have been installed																		
Other Notes	Inliner is not NSF 61 listed so not appropriate for potable water.																		
III. Technology Design, Installation, and QA/QC Information																			
Product Standards	ASTM D5813																		
Design Standards	ASTM F1216, Appendix XI (Design Considerations)																		
Design Life Range	50 year design life																		
Installation Standards	ASTM F1216 for inversion, ASTM F1743 for pull in place																		
Installation Methodology	The CIPP tube is inserted by either inversion using water or air, or pulled into place. For inversion the tube is inflated by either water or air pressure. If using the pull in place method, a calibration hose or removable bladder is inverted inside the felt tube after the tube is pulled in to position. Curing is by either hot water or hot air (steam) in either case.																		
QA/QC	Prior to lining, the line should be cleaned and CCTV used to locate laterals, connections, offsets, diameter transitions, etc. After lining, CCTV is used again to locate any anomalies or defects (bulges, wrinkles, etc.) in the liner. Either restrained samples, or specially made flat plate samples, using the same resin and felt fabric, are made and tested for conformance to minimum flexural properties.																		
IV. Operation and Maintenance Requirements																			
O&M Needs	Standard CCTV inspection and water cleaning																		
Repair Requirements for Rehabilitated Sections	CIPP Short Sectional point repairs readily available from several contracting firms																		
V. Costs																			
Key Cost Factors	Mobilization affects cost when contract contains minimal segments of CIPP lining. Generally speaking, a project of 3,000 linear feet or more will offset any effect of mobilization on cost. Diversion or by-pass pumping requirements can have a significant impact on cost. For materials, recent fluctuations in the cost of the resin and fuel have impacted costs of the installed CIPP																		
Case Study Costs	Not available.																		
VI. Data Sources																			
References	Inliner Design Guide (March 2008), Inliner Technical Brochure (no date)																		

Technology/Method	CIPP/Inversion with Hot Water Cured
I. Technology Background	
Status	Emerging
Date of Introduction	1995
Utilization Rates	44 miles since 1995
Vendor Name(s)	Insituform PPL® (Pressure Pipe Liner) Insituform Technologies, Inc. 17999 Edison Ave., Chesterfield, MO 63005 Phone: 636-530-8000 Fax: 636-519- 8744 Web: www.insituform.com
Practitioner(s)	14,000 feet of 16 to 30 inches Fire Water Piping Alyeska Marine Terminal Valdez, AK Mr. Kent Peterson Alyeska Pipeline 907-834-7357 750 feet of 18 inches Sewage Force Main Lake Waukomis, MO Mr. Charles Raab Sr. Technical Advisor TREKK Design Group, LLC 1441 East 104 th St., Suite 105 Kansas City, MO 64131 816-874-4662 crabb@trekklc.com 125 feet of 47 inches Cooling Water Piping Citgo Petroleum Corporation Lake Charles, LA Mr. Ronnie Nichols Planner Citgo Petroleum Corporation Clifton Ridge Road Lake Charles, LA 70633 318-708-8580
Description of Main Features	Insituform PPL is a custom engineered CIPP product designed to eliminate leaks and prevent internal corrosion and/or erosion in structurally sound pressure pipes. It is an interactive liner that will span small holes, pits or open joints in the host pipe. The CIPP tube has a similar construction to standard Insituform CIPP tubes, with special glass reinforcement included to handle pressure applications. Resins used are either vinyl ester or epoxy (special epoxy for potable water applications).
Main Benefits Claimed	<ul style="list-style-type: none"> • Spans over small holes, gaps or open joints. • Extends life of a deteriorated or leaking pressure pipe. • Minimal disruption as installed inside existing main, trenchlessly. • Smooth interior surface. • Stops internal corrosion. • Can be installed in line with bends up to 90°.
Main Limitations Cited	<ul style="list-style-type: none"> • Interior must be very clean, with no protrusions. • Shut down system or by-pass pump during insertion and cure. • Not fully structural so host pipe must continue to carry internal pressure and external load. • Designed to resist external pressures due to groundwater when the host pipe is empty.
Applicability (Underline those that apply)	<u>Force Main</u> Gravity Sewer Laterals Manholes Appurtenances <u>Water Main</u> Service Lines Other: <u>Process Lines</u>

Technology/Method		CIPP/Inversion with Hot Water Cured																
II. Technology Parameters																		
Service Application	Water (potable), Gravity and Low Pressure Wastewater, Industrial - cooling water, fire water, and process lines																	
Service Connections	Liner stops and starts at connections, which must be reinstated via open cut.																	
Structural Rating Claimed	Class III – Semi-Structural, capable of bridging holes, gaps and joints while the host pipe carries the full internal pressure																	
Materials of Composition	<p>Vinyl ester or epoxy resins (special epoxy for potable water), standard Insituform CIPP non-woven felt tube but with special glass reinforcement included.</p> <p>Minimum Physical Properties (25°C)</p> <table border="1"> <thead> <tr> <th>Property</th> <th>ASTM Method</th> <th>Value</th> </tr> </thead> <tbody> <tr> <td>Initial Flexural Modulus of Elasticity</td> <td>D790</td> <td>250,000 psi</td> </tr> <tr> <td>Initial Flexural Strength</td> <td>D790</td> <td>6,500 psi</td> </tr> <tr> <td>Initial Tensile Strength</td> <td>D638</td> <td>5,000 psi</td> </tr> <tr> <td>Initial Tensile Modulus</td> <td>D638</td> <td>300,000 psi</td> </tr> </tbody> </table> <p>For design of spanning over small holes, the flexural strength is reduced to 1/3rd of the initial value for long-term performance. In addition, a factor of safety of 2 is utilized.</p>			Property	ASTM Method	Value	Initial Flexural Modulus of Elasticity	D790	250,000 psi	Initial Flexural Strength	D790	6,500 psi	Initial Tensile Strength	D638	5,000 psi	Initial Tensile Modulus	D638	300,000 psi
Property	ASTM Method	Value																
Initial Flexural Modulus of Elasticity	D790	250,000 psi																
Initial Flexural Strength	D790	6,500 psi																
Initial Tensile Strength	D638	5,000 psi																
Initial Tensile Modulus	D638	300,000 psi																
Diameter Range, inches	8-60 inches																	
Thickness Range, inches	0.3-0.7 inches (8–18 mm)																	
Pressure Capacity, psi	Up to 200 psi																	
Temperature Range, °F	120°F																	
Renewal Length, feet	200 to 1,000 feet																	
Other Notes	All terminations must be fitted with mechanical end seals.																	
III. Technology Design, Installation, and QA/QC Information																		
Product Standards	Special epoxy used for potable water applications – NSF 61 listed																	
Design Standards	ASTM F1216, Appendix X1.3.1																	
Design Life Range	50 years																	
Installation Standards	F 1216																	
Installation Methodology	<p>Pipeline is to be cleaned and all debris removed from the interior. CCTV should be performed before lining. All obstructions, including reducers, line valves and protruding connections to be removed. The reinforced Insituform felt tube is resin saturated either in the factory or on site and prepared for installation. On site, the tube is positioned in the pipeline using water pressure to turn the tube inside out (inversion). The water pressure forces the tube to a close fit with the host pipe. After positioned, the resin is cured by circulating hot water through the tube. Once cured, the pipe is cooled to a maximum of 90°F. The ends are cut and sealed. Expansion type end seals with expandable stainless steel bands and elastomeric seals are used for this purpose. The pipe may be returned to service after CCTV inspection and pressure testing.</p>																	
QA/QC	<ul style="list-style-type: none"> • Prior to insertion of tube, CCTV inspection of main needed to locate any obstructions, protrusion, changes in diameter or in-line valves that could affect liner. • After insertion and cure, liner inspected again visually with CCTV, and any abnormalities are noted. • For each inversion length, one liner sample, suitable in size to yield 5 specimens, is collected either from a section of the cured pipe lining (usually at termination point) or a flat plate sample and subjected to flexural and tensile testing. Average values should exceed minimums used for design. • Pressure testing to be carried out after liner has reached original ambient ground temperature. The liner and host pipe subjected to a hydrostatic internal pressure equal to twice the known operating pressure, or operating pressure plus 50 psi, whichever is less. After stabilization period of 2-3 hours, test period is one hour. Limit on make-up water to maintain pressure 																	

Technology/Method	CIPP/Inversion with Hot Water Cured
	is 20 gallons per inch diameter per mile of pipe per day.
IV. Operation and Maintenance Requirements	
O&M Needs	Minimal. Inspect pipe in accordance with the owner's asset management plan.
Repair Requirements for Rehabilitated Sections	Excavate, remove damaged portion of PPL and host pipe (if necessary), install end seals and bridge previously damaged location with new pipe and couplers as required.
V. Costs	
Key Cost Factors	By-pass requirements, host pipe cleaning, pipe diameter and length, tube thickness, number of appurtenances (valves, fittings, fire hydrants, air release valves, etc), excavation requirements. In order, most costly materials are resin, tube, and end seals.
Case Study Costs	Not available.
VI. Data Sources	
References	www.insituform.com

Technology/Method		CIPP/Direct Inversion/Pull in Place/Hot Water and Steam Cured
I. Technology Background		
Status	Conventional	
Date of Introduction	1995	
Utilization Rates	Install approx. 200 miles of liner per year. Have only started pressure pipe installations in past several years.	
Vendor Name(s)	National Liner® National EnviroTech Group 12707 North Freeway, Suite 490 Houston, TX 77060 Phone: 281-874-0111 Email: info@nationalliner.com Web: www.nationalliner.com	
Practitioner(s)	Not available.	
Description of Main Features	National Liner is a CIPP product made of a non-woven, needled, polyester felt that is shop or site impregnated with a thermosetting polyester resin. Vinylester resins are used for pressure applications. A new composite structure, incorporating glass fiber reinforcement, is being developed for pressure applications.	
Main Benefits Claimed	<ul style="list-style-type: none"> • No-dig (or minimum excavation) renovation. • Excess resin mechanically locks tube to host pipe by filling in cracks. • Smooth interior surface for improved flow characteristics. • 7 licensed and trained installation contractors covering US market. 	
Main Limitations Cited	<ul style="list-style-type: none"> • No ASTM product standard for CIPP pressure pipe liners. • No long-term tensile or pressure regression data for pressure applications. • Limited experience with pressure (force main) projects. 	
Applicability (Underline those that apply)	<u>Force Main</u> <u>Gravity Sewer</u> <u>Laterals</u> <u>Manholes</u> <u>Appurtenances</u> <u>Water Main</u> <u>Service Lines</u> Other: <u>Storm Sewers</u>	
II. Technology Parameters		
Service Application	Gravity and Low Pressure Wastewater	
Service Connections	Reinstate gravity laterals remotely. No provisions for reinstating pressure connections.	
Structural Rating Claimed	Class II/III – Semi Structural for felt, Class IV – Structural for glass	
Materials of Composition	Non-woven polyester felt material (from Applied Felts) which is saturated with either an isophthalic or vinylester polyester resin, depending on application. Force mains use vinylester. A new composite structure that incorporates glass fiber for higher pressure is being developed.	
Diameter Range, inches	6-120 inches	
Thickness Range, inches	4.5 mm to 33.5 mm with felt tube are typical, but greater thickness are possible	
Pressure Capacity, psi	50 psi with polyester felt tube, higher with glass fiber composite	
Temperature Range, °F	w/PE resin up to 205°F; w/VE resins up to 248°F	
Renewal Length, feet	Small diameters up to 800 feet; Large diameters up to 2000 feet in one installation	
Other Notes	BOH Brothers and Visu-Sewer Clean & Seal both have reported doing sewer force mains.	
III. Technology Design, Installation, and QA/QC Information		
Product Standards	ASTM D5813 (Gravity Sewer) – none for pressure applications	
Design Standards	ASTM F1216, Appendix X1, WRc, and standard engineering design using resources such as RERAU report R4A2-18	
Design Life Range	50 years	
Installation Standards	ASTM F1216, ASTM F1743	
Installation Methodology	All mains to be cleaned and CCTV inspected before start of lining. The resin saturated tube is inverted into the main using a column of water or pressurized	

Technology/Method	CIPP/Direct Inversion/Pull in Place/Hot Water and Steam Cured
	air. The pressure required to properly expand the tube to the host pipe is given by the tube manufacturer. Once in place the liner is cured by heating the water or air up to the temperature required to initiate polymerization of the resin system.
QA/QC	The host pipe is cleaned and CCTV used prior to installation of the liner. Any changes in dimensions or offsets can be accommodated in the design of the liner so best if this is done well in advance of the planned installation. Samples of the cured liner are taken per 8.1.1 or 8.1.2 of ASTM F1216. In addition to dimensional checks of the liner samples (outside diameter, wall thickness), flexural properties (ASTM D790) and tensile properties (ASTM D638) are also determined.
IV. Operation and Maintenance Requirements	
O&M Needs	The condition of the CIPP should be monitored and maintained on a routine basis consistent with that of other piping in the system. The conditions should be coded per a standardized methodology. Should a defect appear requiring repairs; those repairs should be as warranted by the type of defect discovered using the techniques available for those type of repairs.
Repair Requirements for Rehabilitated Sections	For restoration of water-tightness to the CIPP wall where damage has occurred or a defect identified; install a part-liner. Where delamination of the PU coating occurs (quite rare); mill off the detached portion of the coating.
V. Costs	
Key Cost Factors	CIPP costs are driven by length of reaches that can be done in a single installation, diameter and thickness of the liners to be installed (material costs), and contractor efficiency. Regarding contractor efficiency, there are two components to consider; mobilization costs and project management skills.
Case Study Costs	Not available.
VI. Data Sources	
References	www.nationalliner.com ; Email correspondence with R. Pavlic

Technology/Method		CIPP/ Inversion and Hot Water or Steam Cured	
I. Technology Background			
Status	Emerging		
Date of Introduction	October 2007		
Utilization Rates	Approximately 10,000 feet of potable water lined in first year		
Vendor Name(s)	Paraliner PW and Paraliner FM NOVOC Performance Resins, LLC 3687 Enterprise Dr. Sheboygan, WI 53083 Phone: 877 803-1700 Fax: 920 803-0695 Website: www. NOVOC.com		
Practitioner(s)	Placer County Water-Auburn, CA (News release Feb. 2009)		
Description of Main Features	Paraliner PW or FM is a resin-impregnated flexible fiberglass/felt tube manufactured by NOVOC Performance Resins. The tube is impregnated by the installation contractor with a 100% solids NOVOC vinyl ester resin. The tube is installed either by the inversion method using a head of water or pulled into place by a winch and inflated with air. The resin is cured by either circulating hot water or steam. Once installed, the liner shall extend from start to end in a continuous tight fitting watertight liner.		
Main Benefits Claimed	<ul style="list-style-type: none"> • Trenchless installation with minimal interruption. • Liner can be cured using hot water or steam. • Short cure times – resins contain no styrene, curing time reduced 30%-50% over other CIPP liners. • Minimal shrinkage to ensure tight fit to host pipe-100% solids. • Green solution – patented NOVOC resin are environmentally responsible with no styrene and no EPA reportable components • NSF 61 listed – okay for potable water • Utilizes licensees to install potable water product • Patent pending service connection fittings 		
Main Limitations Cited	<ul style="list-style-type: none"> • By-pass required during lining and cure. • Main must be well cleaned with mechanical scrappers or power boring. • No long-term pressure regression or tensile testing to confirm a hydrostatic design basis for 50 year design life. 		
Applicability (Underline those that apply)	<u>Force Main</u> <u>Gravity Sewer</u> <u>Laterals</u> Manholes Appurtenances <u>Water Main</u> Service Lines Other:		
II. Technology Parameters			
Service Application	Water – potable and raw water, Wastewater – force mains, gravity sewer		
Service Connections	Reinstate after curing. Can be done robotically from within for corporation connections. Larger connections must be excavated and reinstated mechanically.		
Structural Rating Claimed	Class IV – Structural, designed to carry full internal and external loads		
Materials of Composition	The tube consists of one or more layers of absorbent non-woven felt fabric. Fiberglass is also included. The outside layer of the tube is coated with an impermeable, flexible membrane that contains the resin and allows monitoring of the impregnation (wet out) process. The resin is NOVOC 4900 PW (for potable water) and is a 100% solids, zero HAP, vinyl ester resin. The resin system emits less than 1% VOCs. It has a glass transition temperature of 591°F. Mean physical properties of the reinforced resin (initial) as follows:		
	<u>Property</u>	<u>Test Method</u>	<u>Value</u>
	Flexural Strength, psi	ASTM D790	16,000 psi
	Flexural Modulus, psi	ASTM D790	940,000 psi
	Tensile Strength, psi	ASTM D638	16,000 psi
	Tensile Modulus, psi	ASTM D638	900,000 psi
	Water Aging – 0.4%		
Diameter Range, inches	6-96 inches and larger		

Technology/Method	CIPP/ Inversion and Hot Water or Steam Cured
Thickness Range, inches	0.18 inches (4.5 mm) to 2.07 inches (52.5 mm)
Pressure Capacity, psi	230 psi Burst Pressure (Based on 8 inches dia. x 6 mm thick)
Temperature Range, °F	220°F
Renewal Length, feet	Approx. 1,000 feet depending on diameter
Other Notes	Include specific notes here such as Water Quality, I/I control, other
III. Technology Design, Installation, and QA/QC Information	
Product Standards	No product standards, NSF 61 listing (for potable water applications) from Underwriters Laboratories
Design Standards	ASTM F1216, Appendix X.1
Design Life Range	50 years
Installation Standards	ASTM F1216, Section 7 and/or ASTM F1743, Section 6
Installation Methodology	<ul style="list-style-type: none"> • The main is first CCTV inspected and cleaned. • The installation contractor impregnates the tube with the NOVOC vinyl ester resin. The liner is then inserted into the main either by direct inversion using water head or pulled in by a winch. The use of a lubricant is recommended. The liner can be installed through a 45° elbow. The pressure head or steam/air pressure needs to fall within NOVOC's recommended guidelines to insure a proper finished thickness and that the liner fits snug to the existing pipe wall, producing dimples at service connections and flared ends at the entrance and exit points. • After inflation, the liner is cured using either circulating hot water or steam. Thermocouples are placed between the liner and the invert of the manhole or end of the host pipe and used to monitor the temperature and time of the exothermic reaction. • Once cured, the liner is cooled down to a temperature of 100°F before relieving the pressure. • The liner is cut to appropriate length to allow fitting of end seals (Miller Pipe "Weko-Seals" or equal) or Full-Circle Pressure Clamps or MJ Fittings.
QA/QC	CCTV main after cleaning, log location of service connections. Likewise, CCTV line after temperature cools to under 100°F to make sure liner was properly installed. Pressure test the line after CCTV inspection, and before reinstating connections, to a minimum of 120% of the normal operating pressure. Line to be CCTV inspected again after service connections are reinstated.
IV. Operation and Maintenance Requirements	
O&M Needs	None identified.
Repair Requirements for Rehabilitated Sections	Paraliner products can be relined and or point repaired.
V. Costs	
Key Cost Factors	<ul style="list-style-type: none"> • To determine whether or not a CIPP application is more cost-effective than other alternatives such as slip-lining or dig-and-replace • If there are environmental sensitivities • Determining the reduction of flow capacity vs. other alternatives • The structural integrity of the existing host pipe • Service downtime
Case Study Costs	No cost case studies available.
VI. Data Sources	
References	References upon request

Technology/Method	CIPP/Inversion with Hot Water Cured
I. Technology Background	
Status	Emerging
Date of Introduction	1998
Utilization Rates	19 miles since 1998
Vendor Name(s)	Insituform RPP™ (Reinforced Pressure Pipe) Insituform Technologies, Inc. 17999 Edison Ave. Chesterfield, MO 63005 Phone: 636-530-8000 Fax: 636-519- 8744 Web: www.insituform.com
Practitioner(s)	1) Zone 7 Water Agency- Alameda County Flood Control and Water Conservation District 5,400 feet of 12 inches RPP on an old cast iron pipe - December 2008 Key Contact: Steven J. Ellis Assistant Engineer Zone 7 Water Agency 100 North Canyons Parkway Livermore, CA 945541 925-454-5037 (direct) 925-454-5726 (fax) sellis@zone7water.com 2) City of Muscatine, IA Sewer force main – 1,700 feet of 24 inches - December 2007 Key Contact: Gary Kleve Sulzberger Excavating 563-263-1697 3) Gainesville Regional Utilities Sewer force main – 330 feet of 16 inches - 2007 Key Contact: John Gifford Gainesville Regional Utilities 352-317-1837
Description of Main Features	Insituform RPP is a custom engineered CIPP product designed to restore the structural integrity to distressed pressure pipes and prevent internal corrosion and/or erosion. It is a structural renewal product that does not rely upon the host pipe. The CIPP tube has a similar construction to standard Insituform CIPP tubes, with special glass reinforcement included to handle pressure applications. Resin used is vinyl ester.
Main Benefits Claimed	<ul style="list-style-type: none"> • Provides a structural renewal. • Spans over small holes, gaps or open joints. • Extends life of a deteriorated or leaking pressure pipe. • Minimal disruption as installed inside existing main, trenchlessly. • Smooth interior surface. • Stops internal corrosion. • Can be installed in line with bends up to 45°.
Main Limitations Cited	<ul style="list-style-type: none"> • Interior must be very clean, with no protrusions. • Shut down system or by-pass pump during insertion and cure. • Incomplete long-term pressure regression tests on cured RPP liner available for confirmation of design values recommended for long-term tensile strength in pressure design (Did not achieve the correct number of bursts during the log time frames to meet the ASTM data requirement).
Applicability (Underline those that)	<u>Force Main</u> Gravity Sewer Laterals Manholes Appurtenances <u>Water Main</u> Service Lines Other: <u>Industrial Pressure</u>

Technology/Method	CIPP/Inversion with Hot Water Cured												
apply)													
II. Technology Parameters													
Service Application	Wastewater, Industrial Cooling Water.												
Service Connections	Liner stops and starts at connections, which must be reinstated via open cut.												
Structural Rating Claimed	Class IV –Structural – handle all external and internal loading. No bonding to the original host pipe wall assumed.												
Materials of Composition	<p>A sewn tube consisting of two or more layers of absorbent non-woven synthetic fiber combined with glass fiber reinforcement. The outside layer of the tube is plastic coated with a translucent flexible material for visual inspection during resin impregnation. A vinyl ester resin, compatible with the inversion and curing process, is used.</p> <p>Minimum Physical Properties (25°C)</p> <table border="1"> <thead> <tr> <th>Property</th> <th>ASTM Method</th> <th>Value</th> </tr> </thead> <tbody> <tr> <td>Initial Flexural Modulus of Elasticity</td> <td>D790</td> <td>250,000 psi</td> </tr> <tr> <td>Initial Flexural Strength</td> <td>D790</td> <td>7,000 psi</td> </tr> <tr> <td>Initial Tensile Strength</td> <td>D638</td> <td>6,000 psi</td> </tr> </tbody> </table> <p>For internal pressure design, a long-term tensile strength equal to 1/3rd of the initial design value is used. In addition, a factor of safety of 2 is utilized.</p>	Property	ASTM Method	Value	Initial Flexural Modulus of Elasticity	D790	250,000 psi	Initial Flexural Strength	D790	7,000 psi	Initial Tensile Strength	D638	6,000 psi
Property	ASTM Method	Value											
Initial Flexural Modulus of Elasticity	D790	250,000 psi											
Initial Flexural Strength	D790	7,000 psi											
Initial Tensile Strength	D638	6,000 psi											
Diameter Range, inches	8-72 inches												
Thickness Range, inches	5–26 mm												
Pressure Capacity, psi	Up to 80 psi, diameter dependent.												
Temperature Range, °F	120°F												
Renewal Length, feet	200 to 1,000 feet												
Other Notes	All terminations must be fitted with mechanical end seals.												
III. Technology Design, Installation, and QA/QC Information													
Product Standards	Not suitable for potable water.												
Design Standards	ASTM F1216, Appendix X1.3.2 for the Fully Deteriorated Pressure Pipe condition.												
Design Life Range	50 years												
Installation Standards	ASTM F1216												
Installation Methodology	<p>Pipeline is to be cleaned and all debris removed from the interior. The line is to be CCTV inspected before lining. All obstructions, including reducers, line valves and protruding connections to be removed. The reinforced Insituform felt tube is resin saturated either in the factory or on site and prepared for installation. On site, the tube is positioned in the pipeline using water pressure to turn the tube inside out (inversion). The water pressure forces the tube to a close fit with the host pipe. After positioned, the resin is cured by circulating hot water through the tube. Once cured, the pipe is cooled to a maximum of 90°F. The ends are cut and sealed. Expansion type end seals with expandable stainless steel bands and elastomeric seals are used for this purpose. The pipe may be returned to service after CCTV inspection and pressure testing.</p>												
QA/QC	<ul style="list-style-type: none"> • Prior to insertion of tube, CCTV inspection of main needed to locate any obstructions, protrusion, changes in diameter or in-line valves that could affect liner. • After insertion and cure, liner inspected again visually with CCTV, and any abnormalities are noted. • For each inversion length, one liner sample, suitable in size to yield 5 specimens, is collected either from a section of the cured pipe lining (usually at termination point) or a flat plate sample and subjected to flexural and tensile testing. Average values should exceed minimums used for design. • Pressure testing to be carried out after liner has reached original ambient ground temperature. The liner and host pipe subjected to a hydrostatic 												

Technology/Method	CIPP/Inversion with Hot Water Cured
	internal pressure equal to twice the known operating pressure, or operating pressure plus 50 psi, whichever is less. After stabilization period of 2-3 hours, test period is one hour. Limit on make-up water to maintain pressure is 20 gallons per inch diameter per mile of pipe per day.
IV. Operation and Maintenance Requirements	
O&M Needs	Minimal. Inspect pipe in accordance with the owner's asset management plan.
Repair Requirements for Rehabilitated Sections	Excavate, remove damaged portion of RPP and host pipe (if necessary), install end seals and bridge previously damaged location with new pipe and couplers as required.
V. Costs	
Key Cost Factors	By-pass requirements, host pipe cleaning, pipe diameter and length, tube thickness, number of appurtenances (valves, fittings, fire hydrants, air release valves, etc), excavation requirements. In order, most costly materials are resin, tube and end seals.
Case Study Costs	Not available.
VI. Data Sources	
References	www.insituform.com

Technology/Method		CIPP/Glass Fiber Reinforced
I. Technology Background		
Status	Innovative	
Date of Introduction	2002 in Sweden, 2004 in Hong Kong and Canada	
Utilization Rates	12 miles/year	
Vendor Name(s)	Nordipipe™ Norditube Technologies (a Sekisui-CPT Company) 501 N. El Camino Real, Suite 224 San Clemente, CA 92672 Phone: 714-267-1030 Web: www.cpt-usa.com/info	
Practitioner(s)	Mr. Jean Lemire, Eng. City of Cornwall 1225 Ontario Street Cornwall (Ontario) Canada K6H 5T9 Tel. (613) 930-2787 Email jelemire@cornwall.ca Mr. Tony Di Fruscia, Eng. P.Eng. City of Montreal 13301, Sherbrooke Street East Suite 209 Montreal (Quebec) Canada H1A 1C2 Tel. (514) 872-6678 Email tonydifruscia@ville.montreal.qc.ca Ms. Annie Fortier, Eng. City of Dorval 60 Martin Avenue Dorval (Quebec) Canada H9S 3R4 Tel. (514) 633-4244 Email afortier@ville.dorval.qc.ca	
Description of Main Features	Norditube is a CIPP system that incorporates a glass fiber reinforced layer between two felt layers, impregnated with epoxy or vinylester resin. A PE coating is on the interior. Resin impregnation is done by the installation contractor, either at his facility or onsite.	
Main Benefits Claimed	<ul style="list-style-type: none"> • Fully Structural – no support of the host pipe required for internal or external loads • NSF 61 listing (cold water, up to 78°F) and BNQ approval for potable water • High pressure resistance • Negotiate bends up to 45 degrees 	
Main Limitations Cited	<ul style="list-style-type: none"> • 48 inches maximum diameter • No US installations 	
Applicability (Underline those that apply)	<u>Force Main</u> <u>Gravity Sewer</u> Laterals Manholes Appurtenances <u>Water Main</u> Service Lines Other:	
II. Technology Parameters		
Service Application	Pressure water and wastewater	
Service Connections	Internal cut and external re-instatement by excavation	
Structural Rating Claimed	Type 4 – Fully structural	
Materials of Composition	Polyethylene coating in contact with potable water, non-woven felt and glass fiber chopped mat, with epoxy or vinyl ester resin. Epoxy is used for potable water projects (NSF listing), and vinyl ester for other applications. Vinyl ester resin is half the cost of the epoxy.	
Diameter Range,	5-48 inches	

Technology/Method	CIPP/Glass Fiber Reinforced
inches	
Thickness Range, inches	0.18–0.94 inches (4.6–24 mm)
Pressure Capacity, psi	6 inches to 250 psi and 48 inches to 60 psi
Temperature Range, °F	100°F with Epoxy and 160°F with vinyl ester
Renewal Length, feet	500-600 feet
Other Notes	12 inches force main installation in Hamburg, Germany using vinylester and 16 inches force main in the UK using epoxy resin
III. Technology Design, Installation, and QA/QC Information	
Product Standards	No product standards, NSF 61 listing (cold water, up to 78°F)
Design Standards	ASTM F1216 Appendix X1
Design Life Range	50-Year Design
Installation Standards	ASTM F1216
Installation Methodology	Air inversion with air/steam cure, or water column inversion with circulated water cure; service reinstatement by internal robotics or external with saddles. Resin impregnation is usually done at the contractor's facility, but onsite is also possible.
QA/QC	Resin yield check for impregnation; pressure gauges for air inversion; temperature monitoring during cure; hydrostatic pressure test and post installation video for acceptance
IV. Operation and Maintenance Requirements	
O&M Needs	Protection of the PE coating during inspection or cleaning
Repair Requirements for Rehabilitated Sections	Install a spool piece with mechanical adapter; Link-Pipe ring repair
V. Costs	
Key Cost Factors	Set-up costs - pit excavation (civil work), mobilization, pipe cleaning/dewatering, site restoration, traffic control, temporary by-pass including road crossings and disinfection, hydrostatic testing, valves, hydrants, tee's (mechanical work), installation and cure, video inspection Material costs – liner, resin, spool pieces, new valves, tee's and hydrants
Case Study Costs	Not available.
VI. Data Sources	
References	Email correspondence with Steve Leffler; Norditube brochure

Technology/Method	CIPP/Pull in Place/UV Cured
I. Technology Background	
Status	Emerging
Date of Introduction	1997; first usage in Europe, outside Europe since 2001
Utilization Rates	2008: 660,000 feet (200,000 m)
Vendor Name(s)	Berolina Liner BKP Berolina Polyester GmbH (a division of Greiffenberger AG) Am. Zeppelinpark, 27 D-13591 Berlin Germany Phone: +49 30 3647 1400 Email: info@bkp.berolina.de Web: www.bkp-berolina.de
Practitioner(s)	Berliner Wasserbetriebe, 10864 Berlin, Germany Mr. Bernhard Czikkus, bernhard.czikkus@bwb.de or Mr. Andreas Rademacher, andreas.rademacher@bwb.de Phone: +49 30 864 44160 PipeFlo Contr. Corp., Mr. Bruce Noble, bruce@pipeflo.ca ; 180 Chatham Street, Hamilton, Ontario L8P 2B6, Canada; phone: 19055727767 Arkil Inpipe GmbH, Mr. Werner Manske, Werner.manske@arkil.de ; Lohweg 46E, 30559 Hannover, Germany; phone: +495119599536 Tuboseal c.c.; Mr. Jean-Louis Frey, jlf@tuboseal.co.za ; P.O. Box 2513; Somerset West, 2 Cape Town, 7129 South Africa; phone: +27824528129
Description of Main Features	The Berolina-Liner is composed of glass-fiber and/or polyester webs impregnated with polyester or vinyl ester resin. The layers are overlapped and staggered giving the tube variable stretching capability. The liner is UV cured. The glass-fiber layer provides sufficient axial strength for pulling the liner into place. BKP produces the Berolina-Liner with a protective inner film and a UV resistant outer film. The inner film is removed after installation. The outer film also prevents resin from migrating into laterals. The liner is delivered pre wet-out and ready for installation. The liner can be stored for up to 6 months without cooling.
Main Benefits Claimed	<ul style="list-style-type: none"> • UV cured resulting in less CO₂ emission and reliable curing results – neither influenced by ground water, temperature and storage time. • For same stiffness, thickness less than a polyester felt product. • Inflation by compressed air (7.5 psig) allows CCTV inspection of liner prior to UV cure. • Suitable for circular and oval profiles. • Designed with ring stiffness classes SN1250-10000 (MPa), which is similar to GRP pipe for direct burial. • Can bridge over profile or cross-section changes. • Highest rating in IKT water impermeability tests.
Main Limitations Cited	<ul style="list-style-type: none"> • BKP production is located in Berlin, Germany. • Not certified for use with potable water. • No long-term pressure regression or tensile testing to substantiate a full structural (Class IV) design.* • No strain corrosion testing as per ASTM D5813 (6.4.2)* • * Tests have been done and certified according to European and Japanese standards. ASTM test will follow.
Applicability (Underline those that apply)	<u>Force Main</u> <u>Gravity Sewer</u> <u>Laterals</u> <u>Manholes</u> <u>Appurtenances</u> <u>Water Main</u> <u>Service Lines</u> Other: <u>Culverts</u>
II. Technology Parameters	
Service Application	Gravity and low pressure wastewater, storm water
Service Connections	Laterals are optically located (with CCTV) after curing and reinstated with robotic cutters. No provisions for pressure connections.
Structural Rating	No claim made in literature, but with stiffness class SN10000 through 20 inches

Technology/Method	CIPP/Pull in Place/UV Cured
Claimed	(500MM), liner suitable for fully deteriorated gravity host pipe.
Materials of Composition	The Berolina-Liner is made of up to 5 layers of glass-fiber and/or polyester web that is impregnated with a UV-light curing polyester resin. BKP uses only ISO NPG resin of the type 1140 according to DIN 16946/2. The resin is qualified for Group 3 in accordance to DIN 18820/1. For demanding requirements, a vinylester resin is used. The inner protective film and outer UV resistant film are flexible, water impenetrable and equipped with a styrene barrier. Minimum initial ring flexural modulus claimed is 1.45×10^6 psi, and the approximate initial tensile modulus 2.03×10^6 psi.
Diameter Range, inches	6-40 inches (other sizes available upon request)
Thickness Range, inches	0.08-0.47 inches (2-12 mm), depending on diameter
Pressure Capacity, psi	New Berolina-LP-Liner (low pressure) currently in test phase with pressure capacity up to 45 psi.
Temperature Range, °F	Polyester resin up to 122°F; Vinylester resin up to 158°F
Renewal Length, feet	1,200 feet (400 m)
Other Notes	Licensed CIPP Corp (Hudson, IA) to be sole nationwide US provider in Nov. 2008. Local contractors acceptable
III. Technology Design, Installation, and QA/QC Information	
Product Standards	According to EN 13566-4/DRAFT INTERNATIONAL STANDARD ISO/DIS 11296-4; ASTM not applicable, new ASTM standard in preparation
Design Standards	ATV-M 127-2; ASTM F1216, Appendix X.1
Design Life Range	Minimum 50 years
Installation Standards	New ASTM standard in preparation; WRc certified installation manual available
Installation Methodology	<ul style="list-style-type: none"> The host pipe is first thoroughly cleaned and CCTV inspected. A protective film sleeve, covering the lower half of the host pipe, is next drawn into the pipe to be rehabilitated by a winch. The Berolina-Liner is then winched into place and both ends are closed off with end cans. The tube is calibrated using compressed air (7.5 psig), which presses the liner against the host pipe's inner wall. The outer UV resistant tube prevents migration of the resin and styrene into the soil and groundwater, and also prevents resin from penetrating the laterals. After expansion of the liner, a special UV light is "fired" and pulled through the liner at a defined speed. A CCTV camera can monitor the liner during the passage of the light train. With the tube ends sealed, the curing occurs free of any emissions. After curing, the inner film is removed leaving a smooth inner surface. Laterals are easily identified (outward expansion of liner) and reinstated using conventional robotic cutters.
QA/QC	<p>BKP controls the quality of the liner with testing of the liner and components at their plant, as well as during and after curing in the field.</p> <p>Qualification testing of the liner has included:</p> <ul style="list-style-type: none"> high pressure water jet cleaning (Hamburg Model) – 60 passes 10,000 hrs fatigue (creep) tests leakage tests (CP308)(water impermeability) Darmstadt tilted drain experiment (abrasion test) burning test <p>The more important QA (factory) requirements are:</p> <ul style="list-style-type: none"> reactivity tests of resin impermeability tests (DIN/EN 1610) wall thickness measurement

Technology/Method	CIPP/Pull in Place/UV Cured
	<ul style="list-style-type: none"> • measurement of initial ring stiffness • 3-point bending test (flexural modulus and strength) • barcol hardness • residual styrene content <p>During installation, the more important QC requirements are:</p> <ul style="list-style-type: none"> • installation pressure diagram • curing speed diagram • number of UV-light used • temperature diagram <p>After installation, the more important QC requirements are:</p> <ul style="list-style-type: none"> • impermeability test • wall thickness • measurement of the initial ring stiffness • 3-point bending test • measurement of the resin content (loss on ignition) • Residual styrene content • CCTV of liner for visual defects
IV. Operation and Maintenance Requirements	
O&M Needs	None
Repair Requirements for Rehabilitated Sections	Use standard methods for GRP-polyester pipes/products
V. Costs	
Key Cost Factors	Totally trenchless method, no pits needed up to installation of 36 inches (depending on manhole cover size). Costs mainly driven by wall thickness (according to static needs) and diameter of pipe. By-pass pumping time and cost is limited due to fast installation procedure. Mobilization and site setup reduced because of small footprint, liner is shipped to site ready for use, and customized equipment, opening of lateral completely possible directly after installation.
Case Study Costs	No project costs available from BKP.
VI. Data Sources	
References	www.bkp-berolina.de , BKP-Berolina brochure (no date), IKT Liner Report 2007

Technology/Method		CIPP/UV Light Cure
I. Technology Background		
Status	Emerging	
Date of Introduction	Developed by Brandenburger in Germany. Introduced by Reline America into US in 2007.	
Utilization Rates	5 million feet installed in 24 countries.	
Vendor Name(s)	Blue-Tek™ Reline America, Inc. 116 Battleground Ave. Saltville, VA 24370 Phone: 866-998-0808 Fax: 276-496-4265 Email: mburkhard@relineamerica.com Web: www.relineamerica.com	
Practitioner(s)	Amarillo, TX	
Description of Main Features	Glass fiber reinforced CIPP liner that is UV cured. The liner strength stems from a seamless, spirally wound glass fiber tube. Polyester, vinylester or ortho resins can be used. All wet out is performed in the factory. The seamless liner has both an interior and exterior film, with the exterior film blocking UV light.	
Main Benefits Claimed	<ul style="list-style-type: none"> • Glass fiber reinforce wall thickness for higher strength and stiffness • Thinner wall than ordinary felt reinforced liners • Good flow characteristics • Fast curing times for both small and large diameters (250 to 750 feet per hour) • Passed the APS Standard Porosity Test with score of 100% • Quality-Tracker™ System for tracking entire curing process (7 steps) with a data logger and retrieval system. • Reduced styrene emission during curing 	
Main Limitations Cited	<ul style="list-style-type: none"> • Not NSF 61 listed – not suitable for potable water • No long-term pressure regression tests for establishing HDB for pressure pipe design – Class III for pressure applications only • 48 inches diameter is upper limited • Limited licensee contractor base in US at the moment 	
Applicability (Underline those that apply)	<u>Force Main</u> <u>Gravity Sewer</u> Laterals Manholes Appurtenances Water Main Service Lines Other:	
II. Technology Parameters		
Service Application	Wastewater, storm water and raw water	
Service Connections	Remote reinstatement of lateral connections similar to other CIPP products. Lateral Hat™ for connection to sewer laterals	
Structural Rating Claimed	Class III or IV, Semi or Fully Structural	
Materials of Composition	Advantex® EC-R glass fiber from Owens Corning and polyester, vinylester or ortho resin depending on application.	
Diameter Range, inches	6 to 48 inches, circular, oval, egg-shaped and square pipes (60 inches in future)	
Thickness Range, inches	>0.14 inches (3.5 mm)	
Pressure Capacity, psi	Short-term flexural modulus – 1.1×10^6 (up to 2.16×10^6 possible) Long-term flexural modulus – 660,000 (1.6 reduction factor) Short-term tensile strength – 20,000 to 26,000	
Temperature Range, °F	Not available.	
Renewal Length, feet	1000 feet	
Other Notes	Not NSF 61 listed yet. May be in the future.	
III. Technology Design, Installation, and QA/QC Information		

Technology/Method	CIPP/UV Light Cure
Product Standards	ASTM F 2019-03
Design Standards	Not available.
Design Life Range	50 year
Installation Standards	Not available.
Installation Methodology	The liner is shipped in special containers and UV protected foil and can be stored for up to 6 months without refrigeration. Sewage flow needs to be either plugged or by-passed. After sewer is cleaned and CCTV inspected, the Blue-Tek liner is winched into the existing pipe, inflated with air (6 to 8 psi) and then cured using a UV light train that is pulled through the pipe. Special care is needed to ensure that the exterior film is not damaged during installation. After curing the inner film is removed and discarded and the liner post CCTV inspected.
QA/QC	<ul style="list-style-type: none"> • Verification of UV lamp intensity and number (wattage) • CCTV inspection of entire line before curing • Record of liners inner air pressure during curing • Documentation of curing speed (feet/min) • Resin reaction temperatures (infrared sensors) • CCTV documentation of curing process • Physical property tests on specimens from the liner, including water-tightness porosity test
IV. Operation and Maintenance Requirements	
O&M Needs	Not available.
Repair Requirements for Rehabilitated Sections	Not available.
V. Costs	
Key Cost Factors	Not available.
Case Study Costs	Not available.
VI. Data Sources	
References	www.relineamerica.com

Technology/Method	CIPP/Glass Reinforcement
I. Technology Background	
Status	Emerging
Date of Introduction	US – 2009
Utilization Rates	Not available
Vendor Name(s)	InsituMain™ Insituform Technologies, Inc 17999 Edison Avenue Chesterfield, MO 63005 Phone: 636-530-8000 Fax: 636-519-8744 Web: http://www.insituform.com
Practitioner(s)	Not Available
Description of Main Features	<ul style="list-style-type: none"> • An AWWA Class IV fully structural pressure rated cured in place technology. • The InsituMain™ system is an ideal solution for the renewal of both distribution and transmission water. • No risk of disrupting or damaging nearby utilities or other underground infrastructure systems.
Main Benefits Claimed	<ul style="list-style-type: none"> • The system has a polyethylene layer on the inside pipe surface which increases the pipe's smoothness, reduces the surface friction and provides an additional corrosion barrier for the pipe. • It can withstand internal pressure and external load requirements. • Eliminates leakage and corrosion. • Adheres to the existing host pipe. • No need for specialty fittings.
Main Limitations Cited	Bypass required
Applicability (Underline those that apply)	<u>Force Main</u> Gravity Sewer Laterals Manholes Appurtenances <u>Water Main</u> Service Lines Other: <u>Industrial Pressure, Fire</u>
II. Technology Parameters	
Service Application	Rehabilitation
Service Connections	No specialty fittings required. In 6 inches and larger pipes service connections can be made by robotic remote access using mechanical sealing apparatus.
Structural Rating Claimed	Exceeds ASTM F1216 and ASTM F1743 standards
Materials of Composition	Epoxy composite layer which is reinforced with glass and polyester fiber materials
Diameter Range, inches	Nominal diameter range from 6 to 36 inches
Thickness Range, inches	Not available
Pressure Capacity, psi	150 psi+ applications
Temperature Range, °F	120°F
Renewal Length, feet	Not available
Other Notes	Suitable for Cast/Ductile Iron, Steel, Asbestos cement, RCP and Thermoplastic. Can do bends up to 45 degrees.
III. Technology Design, Installation, and QA/QC Information	
Product Standards	Certified to ANSI/NSF 61 standards
Design Standards	Not available
Design Life Range	50 years Design Life
Installation Standards	In accordance with manufacturer's operation manual.
Installation Methodology	<ol style="list-style-type: none"> 1. The composite materials are saturated with a thermosetting epoxy resin system either on the job-site or in an authorized Insituform wet out facility. 2. Using water or air pressure, the tube is then inserted into the host pipe by either a pull-in or inversion method.

Technology/Method	CIPP/Glass Reinforcement
	3. Following installation, hot water or steam is used to cure the thermosetting resin. 4. The pipe is cooled, the ends are cut and the pipe is returned to service. Lined sections are re-established to the existing system using standard pipe fittings.
QA/QC	Inspection of main prior to installation. Followed by post-installation inspection, pressure testing (at twice the operating pressure).
IV. Operation and Maintenance Requirements	
O&M Needs	Disinfection of system before pressing it in to service.
Repair Requirements for Rehabilitated Sections	Excavate, remove the damaged portion of the pipe, install end couplers and bridge the previously damaged location with new pipe and couplers.
V. Costs	
Key Cost Factors	Not available
Case Study Costs	Not available
VI. Data Sources	
References	http://www.insituform.com/mm/files/InsituMain%20Brochure.pdf

Technology/Method	CIPP with Carbon Fiber/Manually Applied
I. Technology Background	
Status	Conventional
Date of Introduction	US Patent 5931198 - Introduced in 1988 in the US market
Utilization Rates	Not available
Vendor Name(s)	<p>FibrWrap The FibrWrap Company Fyfe Co. LLC Nancy Ridge Technology Center 6310 Nancy Ridge Drive, Suite 103 San Diego, CA 92121-3209 Phone: 858-642-0694, 858-642-0947 Email: info@fyfeco.com Web: http://www.fyfeco.com</p>
Practitioner(s)	<p>Gary Schult Project Sponsor Kiewit Western Company For 60 inches through 96 inches PCCP pipes Phone: 602-437-7841</p> <p>John Galleher Senior Engineer San Diego County Water Authority For Pipeline 5: 2 sections of 24 feet for 96 inches pipe 610 W 5th Avenue Escondido, CA 92025 Phone: 760-488-1991 Cell: 760-233-3206</p> <p>Don Lieu and Robert Diaz Chief and Engineering Project Manager Utility Design Division Department of Public Works Bureau of Engineering Howard County, MD Cell for Mr. Lieu: 410-313-6121 Cell for Mr. Diaz: 410-313-6125</p>
Description of Main Features	The Tyfo® Fibrwrap® Pipe Rehabilitation System is a Fiber-Reinforced Polymer (FRP) method, utilizing carbon fiber, for the repair, strengthening and retrofit of corrosion-damaged and distressed large diameter PCCP, RCCP, and steel pressure pipelines used in municipal, industrial and other applications. It's main use has been for PCCP water and force mains that have broken prestressed wires.
Main Benefits Claimed	<ul style="list-style-type: none"> • Restoration of pipelines structural integrity to original load bearing capability (pressure and external) • Can be designed to increase pipeline strength over and above original design • Non-metallic material ensures that corrosion-related damages do not recur in rehabilitated pipe segments • NSF 61 certified system for potable water • Thin liner minimizes any loss of flow capacity
Main Limitations Cited	<ul style="list-style-type: none"> • Limited to sectional repairs as cost can be high • Requires highly trained and experienced technicians to work in confined space with volatile chemicals • Surface preparation for good bond extremely important • Joint termination is an evolving technology • No standardized design approach
Applicability (Underline those that apply)	Force Main Gravity Sewer Laterals Manholes Appurtenances <u>Water Main</u> Service Lines Other: <u>Tunnel</u>

Technology/Method	CIPP with Carbon Fiber/Manually Applied
II. Technology Parameters	
Service Application	Water and wastewater
Service Connections	No method established for service connections. Only suitable for pipe sections with no fittings.
Structural Rating Claimed	Fully structural rehabilitation of only distressed pipe segments –Class 4
Materials of Composition	Layers of FRPs (carbon fibers and glass fibers for electrical isolation from steel), epoxy
Diameter Range, inches	30 through 201 inches and above
Thickness Range, inches	0.08 to 1 inches
Pressure Capacity, psi	50 psi to 350 Psi
Temperature Range, °F	220°F
Renewal Length, feet	16 to 20 feet pipe sections – 5 to 15 sections per project typical
Other Notes	Care should be taken during installation to prepare the surface for bonding and the humidity must be controlled. Water blasting surface down to aggregate is recommended. Long term durability has not yet been qualified, but should be similar to other reinforce plastic pipes (i.e. fiberglass pipe). Negligible loss of pipe capacity.
III. Technology Design, Installation, and QA/QC Information	
Product Standards	ANSI/NSF 61 certified
Design Standards	<p>There are no design standards covering the application of carbon fiber composite as a liner to strengthen PCCP pipe. Some design methods determine required composite thickness based on limiting stress in steel cylinder assuming 100% loss of prestress wire. Limit is usually 75-85% of steel's yield strength. Ultimate design tensile strength of the carbon composite is 120,000 psi.</p> <ul style="list-style-type: none"> • ASTM G 53, Biological Growth Support Potential Test (BGSP) cleared • Long Term Durability Testing by Metropolitan Water District of Southern California. • External loading from soils should be considered and accommodated in the design accordingly. • ACI 503R-93, ACI 546R-96, ASTM D 3039-93 and ASTM D 695-02a.
Design Life Range	Minimum 50-year service life
Installation Standards	No consensus standards. ICC Pmg Report and Fyfe Co. QA/QC
Installation Methodology	<p>Internal surface of PCCP is first hydroblasted to aggregate. Any cracks in the core are repaired with an epoxy. Line is then dehumidified. An epoxy tack coat is first applied to the substrate to increase adhesion of the carbon laminate. The carbon fiber fabric is impregnated with the epoxy resin and hand applied to the inner wall. Fibrwrap uses Tyfo 2X which has two plies of carbon textile bonded together. The composite is placed circumferentially such that the carbon fiber is oriented in the hoop direction. One ply in the axial direction is often used too.</p> <p>When necessary, protective coatings can be applied for aggressive chemical or environmental exposures. Fibrwrap also places a topcoat of an NSF 61 certified epoxy over the underlying composite.</p> <p>It generally take a 3 man crew one day to repair a section of pipe.</p>
QA/QC	<p>As per manufacturer provided manual, which includes responsibility sharing on site and in lab, manufacturing specifications, installation controls, storage, testing, certifications, calibrations, complaints and inspection.</p> <p>Two test panels, 12 inches x 12 inches each, are created each day of the materials used in that days construction. One panel is then later cut into coupons and tensile and flexural tested to confirm design properties. Results are reported back to the owner within 3 weeks. Second panel is held as a referee panel in case the samples</p>

Technology/Method	CIPP with Carbon Fiber/Manually Applied
	fail to meet the minimum design criteria.
IV. Operation and Maintenance Requirements	
O&M Needs	Indicated and provided by manufacturer.
Repair Requirements for Rehabilitated Sections	Periodic visual inspections every two years would be ideal. Top coat renewal feasible if abrasive environment. Any debonded composite to be removed and new laminate applied.
V. Costs	
Key Cost Factors	Exact pricing will depend on: <ol style="list-style-type: none"> 1) Distance from repair location to surface access. 2) Quantity of lineal feet contracted 3) Lead time for crews mobilization 4) Allotted time for onsite completion of project 5) Project service life of repair
Case Study Costs	The cost for the carbon fiber application is about \$75 to \$90 per layer and per feet ² of surface area. Typically, a 54 inches pipe operating at 150 psi with 12 feet of cover would be \$3,000/feet.
VI. Data Sources	
References	http://www.fibrwrapconstruction.com/pipe.htm http://www.fibrwrapconstruction.com/pipe/pipebrochure.pdf www.fyfeco.com Correspondence via E-mail and a binder provided by Mr. Heath Carr.

Technology/Method		CIPP with Carbon Fiber, Manually Applied	
I. Technology Background			
Status	Emerging		
Date of Introduction	Invented and introduced in 1989 at The Arizona State University. Developed and largely used in the South-Western states.		
Utilization Rates	Over 100,000 linear feet have been wrapped by the CarbonWrap family of products across the country		
Vendor Name(s)	CarbonWrap CarbonWrap™ Solutions LLC 3843 N. Oracle Rd. Tucson, Arizona 85705 USA Fax: (520) 408-5274 Toll Free: (866) 380-1269 Phone: (520) 292-3109 E-mail: info@carbonwrapsolutions.com Web: http://www.carbonwrapsolutions.com		
Practitioner(s)	Not available		
Description of Main Features	Application of carbon fiber composite to interior surface of pipe. Carbon Wrap™ is used to strengthening buried pipes, especially PCCP with broken wires. Concrete and steel pipes can be strengthened to take pressures even greater than that of their original design.		
Main Benefits Claimed	<ul style="list-style-type: none"> • Requires no excavation. • Increases pipe strength to even higher than its original pressure rating. • Requires no heavy equipment for installation. Access thru 24 inches manways. 		
Main Limitations Cited	<ul style="list-style-type: none"> • Cannot be used if the temperature is above 200°F • Cost for application can be high versus post-tensioning with steel tendons. 		
Applicability (Underline those that apply)	<u>Force Main</u> <u>Gravity Sewer</u> <u>Laterals</u> <u>Manholes</u> <u>Appurtenances</u> <u>Water Main</u> <u>Service Lines</u> Other: _____		
II. Technology Parameters			
Service Application	Repair		
Service Connections	This repair technique is only good for the pipe barrel, and no fittings or connections.		
Structural Rating Claimed	Structural material		
Materials of Composition	Epoxy resin and carbon fiber		
Diameter Range, inches	Man entry (36 inches) and larger		
Thickness Range, inches	0.125 inches and larger		
Pressure Capacity, psi	Equal or greater than original pipe, if desired.		
Temperature Range, °F	Application in humid temperature is not recommended.		
Renewal Length, feet	Typically repair is confined to one pipe section at a time, without bridging over joints.		
Other Notes	Not available		
III. Technology Design, Installation, and QA/QC Information			
Product Standards	NSF 61 compliant		
Design Standards	ACI 440 (design standard for externally bonded FRP systems for concrete structures)		
Design Life Range	Minimum 25 years		
Installation Standards	As per manufacturer guidelines.		
Installation Methodology	In the case of 36 inches and larger diameter pipes, simple access is made through the manholes and all operations are conducted internally. If the pipe can be accessed from the outside, the wrapping can be performed on the outside face of		

Technology/Method	CIPP with Carbon Fiber, Manually Applied
	the pipe; resulting in the same benefits. It is generally applied in the following format: Epoxy-fiber-epoxy-fiber.
QA/QC	Not available
IV. Operation and Maintenance Requirements	
O&M Needs	Regular cleaning is not required. Maintenance strategies should include condition assessment measures every few years.
Repair Requirements for Rehabilitated Sections	Re-lining may be done.
V. Costs	
Key Cost Factors	The composite material is generally the key governing cost in the contracts. It may vary from job to job depending on site accessibility and pipe condition.
Case Study Costs	Material cost at \$10-\$15/square feet per layer
VI. Data Sources	
References	http://www.carbonwrapsolutions.com/PDFinfo/Brochure.pdf Phone correspondence with Dr. Hamid Saadatmanesh. Email correspondence with Faro Mehr.

Technology/Method		Woven Hose Lining/Epoxy Adhesive
I. Technology Background		
Status	Conventional	
Date of Introduction	Not Available	
Utilization Rates	Not Available	
Vendor Name(s)	Starline HPL-W Starline Trenchless Technology, LLC 1700 South Mount Prospect Road Des Plaines, IL 60018-1804 USA Phone: 847-768-0889 Mail: edward.johnston@gastechnology.org	
Practitioner(s)	Czech Republic	
Description of Main Features	For use in rehabilitation of drinking water mains	
Main Benefits Claimed	Not available	
Main Limitations Cited	Not available	
Applicability (Underline those that apply)	<u>Force Main</u> Gravity Sewer Laterals Manholes Appurtenances <u>Water Main</u> Service Lines Other: _____	
II. Technology Parameters		
Service Application	Rehabilitation	
Service Connections	Need to be addressed separately. Can be identified externally via digging or internally via robot.	
Structural Rating Claimed	430 psi (30 bar) per DVGW	
Materials of Composition	Polyester woven liner, adhesive and epoxy coatings	
Diameter Range, inches	3 to 24 inches	
Thickness Range, inches	Not available	
Pressure Capacity, psi	Up to 430 psi	
Temperature Range, °F	Recommended for use up to 78°F	
Renewal Length, feet	Not available	
Other Notes	Not available	
III. Technology Design, Installation, and QA/QC Information		
Product Standards	All requirements for the technology's application in drinking water pipes in Germany, the KTW recommendations for application of plastics in drinking water pipes and the DVGW W270 Recommended Practice (German Association of Gas and Water), have been complied with. The relevant U.S. certificate, NSF 61 (National Sanitation Foundation), has been applied for and is expected in 2010.	
Design Standards	Not available	
Design Life Range	50 years per DVGW certification	
Installation Standards	Not available	
Installation Methodology	The liner has to be pressed through calibrated rollers before it is pushed into the pipe. Liner is then wound on a pressure drum and bolted into an inversion cone attached to the host pipe. The liner is inverted inside the host pipe and the process ends when the liner reaches the catch basket.	
QA/QC	Not available	
IV. Operation and Maintenance Requirements		
O&M Needs	Not available	
Repair Requirements	Not available	

for Rehabilitated Sections	
V. Costs	
Key Cost Factors	Not available
Case Study Costs	Not available
VI. Data Sources	
References	http://www.starlinett.com/index.htm

Technology/Method		Woven Hose Lining/Adhesive	
I. Technology Background			
Status	Innovative		
Date of Introduction	2000 in Canada and 2005 in USA		
Utilization Rates	With the help of its licensees, over 800,000 feet (250,000 meters) of Aqua-Pipe have been installed over the past eight years throughout Eastern Canada and the United States.		
Vendor Name(s)	Aqua-Pipe® Sanexen Environmental Services Inc. 1471 Lionel-Boulet boulevard Suite 32 Varenes (Quebec) Canada J3X 1P7 Phone: 800-263-0787 Web: http://www.aqua-pipe.com Email: aqua-pipe@sanexen.com		
Practitioner(s)	John Vose City of Naperville 630-420-6741 1200 W Ogden Naperville, IL 60563 USA Kevin Bainbridge City of Hamilton 905-546-2424 x 5677 320-77 James Street North, Hamilton, ON L8R 2K3 Canada Kamran Sarrami City of Toronto 416-395-6370 North York Civic Center, 2nd Floor Toronto Ontario M2N 5V7 Canada		
Description of Main Features	Sanexen, in collaboration with the National Research Council Canada (NRC) developed a new structural liner for the structural rehabilitation of drinking water mains. Aqua-Pipe is an economical and viable alternative to the water main problems where, in the past, dig and replace was the only choice. Aqua-Pipe is a class IV structural liner that is designed and manufactured with mechanical properties exceeding all specifications and meeting drinking water requirements.		
Main Benefits Claimed	<ul style="list-style-type: none"> • Rapid installation of ± 2,500 feet (800 meters) per week and negotiates bends less than 90°. • Added life for water main because of corrosion resistance and no effect on water quality. • Economic considerations include low carbon footprint. 		
Main Limitations Cited	Cannot negotiate 90° bends		
Applicability (Underline those that apply)	<u>Force Main</u> Gravity Sewer Laterals Manholes Appurtenances <u>Water Main</u> Service Lines Other: _____		
II. Technology Parameters			
Service Application	Rehabilitation and Replacement		
Service Connections	The service connections are reinstated from within using a remote controlled mechanical robot. A CCTV system is used for monitoring the operation. Water tightness is preserved by the resin that surrounds the threaded cavities of the service connections and ensures a tight bond with Aqua-Pipe.		

Technology/Method	Woven Hose Lining/Adhesive
Structural Rating Claimed	Class IV (AWWA M28 Manual) fully structural independent liner
Materials of Composition	<ul style="list-style-type: none"> • Composite of woven seamless textile jacket with resin and polymeric membrane • Aqua-Pipe is composed of two concentric, tubular, plain woven polyester jackets with a polymeric membrane bonded to the interior to ensure water tightness. • The liner is impregnated with a specific thermoset epoxy resin that allows a tight bond between the liner and the host pipe.
Diameter Range, inches	6 to 12 inches
Thickness Range, inches	3 to 6 mm
Pressure Capacity, psi	Maximum operating pressures up to 150 psi
Temperature Range, °F	35°F to 100°F
Renewal Length, feet	Up to 500 feet (150 meters) between access pits. The distance between access pits determines the length of the segment.
Other Notes	Hazen-Williams coefficient > 120
III. Technology Design, Installation, and QA/QC Information	
Product Standards	Aqua-Pipe is certified by NSF to NSF/ANSI 61 and under BNQ Standard 3660-950.
Design Standards	The mechanical properties of Aqua-Pipe exceed ASTM F1216 and ASTM F1743 recommendations.
Design Life Range	50+ years
Installation Standards	Aqua-Pipe is precisely aligned with the host pipe's point of entry and pulled through to the exit point.
Installation Methodology	<p>The shaping of Aqua-Pipe is achieved by pushing a pig through the hose using water pressure. Circulating hot water ensures the curing process. Pulled-in-Place Piping (PIPP) method.</p> <p>This product requires the following cure time, temperature, and flush:</p> <ul style="list-style-type: none"> • Day 1: Cure 1.5 hours at 65°C and 25 psi water pressure, then cure for 12 hours at ambient temperature and 50 psi water pressure • Day 2: Flush at 2.8 liters per minute for 24 hours at ambient temperature • Day 3: Cure for 24 hours at ambient temperature <p>Requires a 1 hour flush with potable water prior to being placed into service.</p>
QA/QC	No special procedures beyond standard manufacturer's recommendations
IV. Operation and Maintenance Requirements	
O&M Needs	No particular maintenance needs; Pressure or dry taps for future service connections can be easily carried out with no special equipment
Repair Requirements for Rehabilitated Sections	Typically need to cut out defective pipe section and replace with new pipe.
V. Costs	
Key Cost Factors	<p>List of parameters or key drivers for the costs.</p> <p><u>Set-up cost:</u> mobilization, temporary by-pass installation, pit excavation & backfill, pipe cleaning & inspection, service plugging & reinstatement, lining, testing, disinfection & site restoration</p> <p><u>Material costs:</u> liner, resin, new pipe & fittings including valves and hydrants</p>
Case Study Costs	Hamilton = \$133/feet (35% savings); Toronto = \$137/feet (50% savings); Naperville = \$186/feet (see case study)
VI. Data Sources	
References	<p>http://www.sanexen.com/en/aquapipe/index.htm</p> <p>http://www.sanexen.com/en/aquapipe/tech_info_product.htm</p> <p>Communication with Valerie Belisle, Michael Davison and Joseph Loiacono</p>

Technology/Method	
Saertex Liner® /CIPP	
I. Technology Background	
Status	Emerging
Date of Introduction	Europe in 1996 /US since 2007
Utilization Rates	2008: about 100 miles
Vendor Name(s)	<p>Saertex-Liner® Saertex multiCom® GmbH Brochterbecker Damm 52 D-48365 Saerbeck Germany Phone: +49 2574 902-400 Fax: +49 2574 902-422 Email: multicom@saertex.com Web: www.saertex-multicom.de</p> <p>SAERTEX multiCom LP 12249 Mead Way Littleton, CO 80125 Phone: 1 866 921-5186 E-Mail: multicom@saertex.com www.saertex-multicom.de</p>
Practitioner(s)	<p>DIRINGER & SCHEIDEL Rohrsanierung GmbH & Co. KG Branch Oldenburg/Mr. Richard Mohr Donnerschweer Straße 82 26123 Oldenburg Phone: +49 441 2096410</p> <p>C&L Water Solutions Inc. Mr. Larry Larsson 12249 Mead Way Littleton, CO 80125 Phone: +1 303 7912521</p> <p>Kleen GmbH Umwelt & Kanaltechnik Mr. Uwe Rieken Böttcherstraße 4 26506 Norden Phone: +49 4931 97207-0</p>
Description of Main Features	<p>The structural portion of the liner is made of several layers of Advantex® (ECR glass) glass fiber reinforcement that is manufactured by SAERTEX multiCom. An inner film (styrene tight) serves as an aid to installation and is removed immediately following the curing process. An external styrene tight film is outside the structural layer complex, followed by an opaque film that protects against UV exposure and damage during insertion. The liner is winched in, after placement of a sliding film, along the invert of the host pipe. Two types of resins can be used: a polyester resin or a vinylester resin for industrial sewage. The liner can be either UV cured or steam cured (catalyst is included for steam curing option).</p>
Main Benefits Claimed	<ul style="list-style-type: none"> • High tensile strength in both radial and axial directions due to glass fiber reinforcement. Handle winching forces. • Excellent material data, like an e-modulus of 1.740×10^6 psi = static needs are achieved with thin wall thickness. • 1/10th the thermal shrinkage of an ordinary polyester felt reinforced liner resulting in annular gap normally less than 0.5%. • Higher long-term modulus than felt liners. • Cure with either UV or steam. • Liner can be placed into service directly after completion of curing process and re-opening of the laterals. • Circular, egg-shaped or box sections can be accommodated.
Main Limitations Cited	<ul style="list-style-type: none"> • More expensive than polyester felt material • Hose liners produced in Germany and shipped to the US warehouse

Technology/Method	Saertex Liner® /CIPP									
Applicability (Underline those that apply)	<u>Force Main (potential)</u> <u>Gravity Sewer</u> <u>Laterals</u> <u>Manholes</u> <u>Appurtenances</u> Water Main <u>Service Lines</u> Other: <u>Storm Water Pipes</u>									
II. Technology Parameters										
Service Application	Gravity sewer, storm water pipes									
Service Connections	Service connections reinstated same as conventional CIPP liners.									
Structural Rating Claimed	Semi structural to fully structural. The Saertex-S-Liner and Saertex-M-Liner have the following short-term flexural properties: <table style="margin-left: auto; margin-right: auto;"> <thead> <tr> <th></th> <th>Saertex-S</th> <th>Saertex-M</th> </tr> </thead> <tbody> <tr> <td>Flexural Strength, psi</td> <td>36,250</td> <td>29,000</td> </tr> <tr> <td>Flexural Modulus, psi</td> <td>1.740 x 10⁶</td> <td>1.015 x 10⁶</td> </tr> </tbody> </table> <p>The S-Liner has a diminution factor of 1.35 for calculating the long-term flexural modulus.</p>		Saertex-S	Saertex-M	Flexural Strength, psi	36,250	29,000	Flexural Modulus, psi	1.740 x 10 ⁶	1.015 x 10 ⁶
	Saertex-S	Saertex-M								
Flexural Strength, psi	36,250	29,000								
Flexural Modulus, psi	1.740 x 10 ⁶	1.015 x 10 ⁶								
Materials of Composition	Advantex® (ECR glass) glass fiber from Owens Corning. Polyester resin from DSM and Scott Bader. Vinylester resin from NRC.									
Diameter Range, inches	6 to 48 inches (150 to 1,200 mm)									
Thickness Range, inches	0.118 to 0.472 inches (3 to 12 mm)									
Pressure Capacity, psi	Not available.									
Temperature Range, °F	Not available.									
Renewal Length, feet	Hose liners up to 1,640 feet (500 m)									
Other Notes	Not available.									
III. Technology Design, Installation, and QA/QC Information										
Product Standards	EN 13566, Part 4									
Design Standards	ATV-M 127, Part 2, NSF 14									
Design Life Range	70 years based on 20,000 hour stress rupture testing									
Installation Standards	DIN EN 1610									
Installation Methodology	Sewer lines need to be cleaned and TV-inspected before start of work. A sliding film is inserted along the invert and packing heads installed at the ends of the liner. The liner is drawn into the existing pipe and then inflated using compressed air. The liner is then cured with either UV light or steam, depending on resin type. The curing process is computer-controlled. After curing the packing heads are removed and the inner film removed, tightness testing can be made at this point. A pproximately 4 hours after curing, laterals or service connections can be reinstated using conventional methods and the line returned to service.									
QA/QC	Host pipe is CCTV inspected prior to lining. After lining, another CCTV inspection is necessary to confirm that there are no wrinkles, delamination or foreign objects (defects) in the liner. Samples, per ASTM F1743 should be obtained and tested for wall thickness, flexural and tensile properties. Exfiltration tests for gravity pipes, with a maximum limit of 50 gal/inch diameter/mile/day, and pressure testing to either twice the working pressure or working pressure plus 50 psi, whichever is less, is recommended in ASTM F1743. Allowable leakage for pressure test is 20 gal/inch diameter/mile/day.									
IV. Operation and Maintenance Requirements										
O&M Needs	Not available.									
Repair Requirements for Rehabilitated Sections	Not available.									
V. Costs										
Key Cost Factors	Not available.									
Case Study Costs	e.g. for 8 inches = approx. \$14/feet material, chemicals, foil, glass fiber and approx. \$12/feet installation, cleaning, mobilization									
VI. Data Sources										
References	Trenchless Technology International, Pumper & Cleaner Magazine									

Technology/Method	Hose Liner/Pulled in Place
I. Technology Background	
Status	Emerging
Date of Introduction	2001 in Germany
Utilization Rates	Between 20 and 30 km per year through 2008
Vendor Name(s)	Primus Line® Raedlinger Primus Line GmbH Kammerdorfer Strasse, 16 Cham D93413 Germany Phone: +49 9971 4003-100 Email: primusline@raedlinger.com Homepage: www.primusline.com
Practitioner(s)	Double-inverted siphon under Lake Bigge. Two 12" drinking water lines, 650 feet long each, 232 psi working pressure. Client: Kreiswasserwerke Olpe Engineer: Bieske & Partner, Lohmar Rising pressure pipe, 20 inches diameter, 363 psi working pressure, 1,350 feet long with 4 - 45° bends. Pipeline located on a 76% slope. Client: Stahlwerke Thüringen AG
Description of Main Features	Seamless woven aramid (Kevlar®) fiber in single or double-layer design embedded in a high performance plastic. The folded pipe is pulled into the existing pipe from a reel. No curing required. Pressure inflates the liner which is then self supporting. Inner liner coating is either PE for water and sewer applications, or TPU for oil and gas.
Main Benefits Claimed	<ul style="list-style-type: none"> • Light weight, 1.6 to 9.1 kg/m depending on diameter and number of layers of fabric. • High strength – burst pressure of 2,580 psi (178 bar) for 6 inches diameter. • Delivered rolled up to 5 miles on one drum. • Easy to install – up to 6,000 feet in a single line. • Could be used for a temporary pressure by-pass line. • Can navigate through a 30° bend.
Main Limitations Cited	<ul style="list-style-type: none"> • Requires a special coupling device (Primus Line connectors) for jointing up to steel, PE or other pipe materials for pressure rates higher than 16 bars. Alternative standard PE or GRP couplings are being tested. • Cannot accept connections so need special connectors (for high pressure) to adapt to fittings. • Would be imported from Germany as no US production.
Applicability (Underline those that apply)	<u>Force Main</u> Gravity Sewer Laterals Manholes Appurtenances <u>Water Main</u> Service Lines Other: <u>Gas and Oil</u>
II. Technology Parameters	
Service Application	Pressure - water, wastewater, oil and gas
Service Connections	No service connections directly to the liner. A special connector (for high pressure applications) is needed at end to join liner, via a flange or weld, to steel pipe or fitting.
Structural Rating Claimed	Class IV, but relies upon host pipe to carry external loads.
Materials of Composition	The Primus Line is made of a low weight fibre woven hose. The hose is constructed of seamless interweaving of Kevlar fibre with an inner and outer coating. The inner coating is a thermoplastic which is smooth and resistant to many media. For water and sewer applications the inner coating is PE, for oil and gas applications the coating is TPU. The outer coating is wear-resistant PE. Kevlar fibre has a tensile strength of 2,920 N/mm ² , or 8 times that of steel.
Diameter Range, inches	6-20 inches (150-500 mm)
Thickness Range, inches	0.24 inches (6.5 mm)

Technology/Method	Hose Liner/Pulled in Place
Pressure Capacity, psi	493 psi for 6 inches (150 mm), 218 psi for 20 inches (500 mm) for single layer of woven fabric; higher with double layer of woven fabric
Temperature Range, °F	60°C
Renewal Length, feet	Up to 6,000 feet (3,000 feet more common)
Other Notes	Certified for drinking water in Germany, but not in North America.
III. Technology Design, Installation, and QA/QC Information	
Product Standards	KTW and W270 for drinking water in Europe, Deutsche Vereinigung des Gas und Wasserfaches (DVGW) Testing Basis VP 643, June 2004
Design Standards	None. Raedlinger's rated pressure of the Primus Liner provides a short-term factor of safety of 2.5 against the burst pressure. Raedlinger's literature states that long-term creep pressure tests are conducted, in accordance to DIN 16887 and ISO 9080, with a safety coefficient of 2.0 applied to the extrapolated 50 year strength.
Design Life Range	Minimum service life of 50 years
Installation Standards	None
Installation Methodology	The existing pipe is first CCTV inspected. The inspection device is fitted with tools suitable for grinding off sharp edges at pipe transitions or welded seams. The pipe is then cleaned using a mechanical pig. Sharp edges can damage the outer PE coating so a special fitting is needed to guide the liner into the host pipe. The Primus Line is pulled from a reel into the pipeline that has been prepared. A special pulling head is fitted to the end of the Primus Line for attaching the cable for pulling. Rate of installation of up to 1200 feet per hour possible. The maximum pulling force is 100 kN. A load cell with recorder is required to monitor and document the pulling force. With the Primus Line in final position, special connectors are fitted on the ends and after curing of the injected resin (Scotchcast™ Cable Resin No. 1471), the connector is used to join the Primus Line via a welded or flanged connection to the original pipe or an adapter.
QA/QC	The host pipe is CCTV inspected for anomalies. The inspection device is fitted with a grinding tool for removal of any sharp edges which could damage the Primus Liner during insertion or operation. After the liner has been completely installed and connectors fitted to the end, the line is hydrostatically pressure tested to ensure leak tightness. Raedlinger recommends a test pressure of 1.1 times working pressure, or a minimum of 30 psi (2 bar) over working pressure.
IV. Operation and Maintenance Requirements	
O&M Needs	None identified.
Repair Requirements for Rehabilitated Sections	Raedlinger did not state what procedures need to be followed to repair a section that has been lined with Primus Line. It would appear that a damaged section would have to be removed and two new special couplings used to install a replacement section.
V. Costs	
Key Cost Factors	<ul style="list-style-type: none"> • Time and cost savings • Only coarse cleaning of the old pipe is necessary; no bonding of the Primus Liner is required • Fast installation process and fast restart of pipeline operation • Savings through minimum construction costs • Reduction of excavation work to a minimum; minimal disruption of public life, no destruction of vegetation, no disturbance of road, rail and shipping traffic
Case Study Costs	The cost for the installation was reported to be about a 70% cost savings versus conventional replacement construction.
VI. Data Sources	
References	Primus Line brochure "Innovative High-Pressure Pipelines for Trenchless Pipe Renewal"; Reference data sheets (8 selected projects) Pressure Rates; Scope of delivery; Installation manual (December 2008); Installation manual connectors

Technology/Method		Glass Reinforced Thermoplastic Liner/Thermoformed
I. Technology Background		
Status	Emerging	
Date of Introduction	2008 – development trials in Europe	
Utilization Rates	Limited -still in development stage	
Vendor Name(s)	Aqualiner Aqualiner Ltd Unit 10, Charnwood Business Park, North Road, Loughborough, Leicestershire, LE11 1QJ, United Kingdom Phone: +44 (0) 1509 210027 Email: info@aqualiner.co.uk Website: www.aqualiner.co.uk	
Practitioner(s)	Three field trials undertaken by Wessex Water. Contact Julian Britton, Manager – Critical Sewers Team, Kingston Seymour STW, Back Lane, Kingston Seymour, Clevedon UK BS21 6UY Tel (44) 01275 875157	
Description of Main Features	Aqualiner involves inserting a glass fiber reinforced polypropylene sock into a deteriorated pipe. Once the composite sock has been inserted into the host pipe, a silicone rubber inflation tube pushes a heated pig through the composite melting the thermoplastic sock against the pipe. The inversion bag presses the molten thermoplastic composite sock against the pipe wall where it cools to form a solid glass reinforced thermoplastic liner.	
Main Benefits Claimed	<ul style="list-style-type: none"> • No mixing of chemicals – long shelf life • Environmentally safe – no releases • Structural – capable of withstanding internal and external pressure • Thin liner – minimizes any loss of capacity with a liner • Trenchless method of installation- minimizes excavation and disruptions 	
Main Limitations Cited	<ul style="list-style-type: none"> • Still in incubation – not commercially released yet • NSF 61 listing and UK approvals in process (DWI Regulation 31). 	
Applicability (Underline those that apply)	<u>Force Main</u> Gravity Sewer Laterals Manholes Appurtenances <u>Water Main</u> Service Lines Other:	
II. Technology Parameters		
Service Application	Water distribution, sewer force mains	
Service Connections	Open cut or robotically restate. Fusion couplings under development	
Structural Rating Claimed	Fully structural (Class IV). Aqualiner will conform to the strain corrosion requirements for a GRP sewer pipe as contained in Table 6 of EN 13566-4:2002 (similar to those in ASTM D3262).	
Materials of Composition	Chopped glass fiber and polypropylene.	
Diameter Range, inches	6-12 inches	
Thickness Range, inches	3-6 mm	
Pressure Capacity, psi	145 psi (10 bar)	
Temperature Range, °F	-5°C to 40°C	
Renewal Length, feet	500 feet of 12 inches	
Other Notes	Not available.	
III. Technology Design, Installation, and QA/QC Information		
Product Standards	None at this time. Closest applicable standard might be EN ISO 15874 – Polypropylene for hot and cold water installations	
Design Standards	None at this time. Closest applicable standard might be EN 13566-4:2002, Plastic piping systems for renovation of underground sewerage networks (CIPP).	
Design Life Range	50-75 years	
Installation Standards	None at this time.	
Installation Methodology	The host pipe is first cleaned and then CCTV inspected for location of laterals and fittings. The liner can be installed through a bend of up to 45 degrees. A pig is	

Technology/Method	Glass Reinforced Thermoplastic Liner/Thermoformed
	inserted into the thermoplastic composite sock. The pig heats the polypropylene until it melts. An inversion drum deploys a silicone rubber inflation tube which pushes the pig through the pipe. Application rate is 0.5 m/min. The inversion bag also presses the molten thermoplastic composite sock against the pipe wall where it cools to form a solid homogeneous thermoplastic composite liner. Pressure in the inversion bag is kept at 45 psi (3 bar). The inversion bag is deflated and removed after the liner cools.
QA/QC	After installation, CCTV inspection should be performed on the liner. The internal surface is to be smooth, clean and free from scoring, cavities, wrinkling, and other surface defects. Samples of the formed liner should be checked for thickness, short-term flexural modulus and tensile strength, but as yet no design values have been provided.
IV. Operation and Maintenance Requirements	
O&M Needs	None identified yet.
Repair Requirements for Rehabilitated Sections	Remove host pipe and Aqualiner. Replace with new pipe section and tie back to existing host pipe with repair clamps.
V. Costs	
Key Cost Factors	<ul style="list-style-type: none"> • Mobilization – one fully equipped installation truck, compressor and generator. • Pipe cleaning as for close fit lining. • Principal costs include liner tube, installation labor, crew size (3-4), and power usage. • Service lateral reinstatement by open cut or remote robotics as per close fit lining.
Case Study Costs	Estimated Cost ~ \$35-\$40/feet
VI. Data Sources	
References	Aqualiner Product Specification Issue 3 (Aug. 12, 2007)

Technology/Method	Sliplining/HDD/Pipe Bursting/Direct Bury
I. Technology Background	
Status	Emerging
Date of Introduction	Introduced November 2003. First commercial installation January 2004
Utilization Rates	Over 2 million linear feet installed since 2004
Vendor Name(s)	Fusible C-900®/Fusible C-905®/FPVC™ Underground Solutions, Inc. (UGSI) 13135 Danielson Street- Suite 201 Poway, CA 92064 Phone: 858-679-9551 Email: info@undergroundsolutions.com Web: www.undergroundsolutions.com
Practitioner(s)	Over 700 projects with municipal and industrial users in 43 out of 50 states, Canada and Mexico. Primarily used for pressurized potable water, reclaim, and wastewater lines
Description of Main Features	Fusible PVC™ pipe is extruded from a specific formulation of PVC resin, which allows the joints to be butt fused together using UGSI's fusion process. Industry standard butt fusion equipment is used with some minor modifications. The resin/compound meets the PVC formulation in PPI Technical Report #2. With the proprietary formulation, the fused joint strength is (minimum 95%) as strong as the pipe wall. The fusible pipe is made in DIPS and IPS OD series, as well as schedule and sewer sizes. The Fusible C-900®, Fusible C-905®, and FPVC™ pipes are NSF 61 certified for potable water.
Main Benefits Claimed	<ul style="list-style-type: none"> • AWWA C900 and C905 PVC pipe • Corrosion resistant, abrasion resistant, high "C" factor at 150 • Fully restrained joint - Fusible PVC™ joints allow long lengths of pipe to be used for HDD, pipe bursting and sliplining applications. • NSF 61 certified for potable water • Use standard fittings and service saddles • Higher strength enables longer pulls and larger inside diameters
Main Limitations Cited	<ul style="list-style-type: none"> • Fusion time for joint is 1.5 to 2 minutes per diameter inch • PVC fusion technicians need to be trained and qualified by UGSI. Qualification only lasts one year. • PVC is impacted by cyclic (fatigue) pressure loadings, which are typically experienced in a force main application. • As a stiff, strong thermoplastic, PVC has specific guidelines for bending radius
Applicability (Underline those that apply)	<u>Force Main</u> <u>Gravity Sewer</u> Laterals Manholes Appurtenances <u>Water Main</u> Service Lines Other: <u>Culverts</u>
II. Technology Parameters	
Service Application	Sliplining, HDD, pipe bursting, direct bury
Service Connections	Reinstate with excavation. Tapping procedure per Uni-bell standards. No direct tapping. Connect to MJ or flanged fittings.
Structural Rating Claimed	Fully structural (Class IV) - carry full internal pressure and external loads independent of the host pipe's remaining strength.
Materials of Composition	Fusible PVC™ is extruded with a unique patent pending formulation that meets PPI TR-2 range of composition of qualified PVC ingredients. Meets ASTM cell classification 12454.
Diameter Range, inches	4-12 inches for Fusible C-900® (potable water) 14-36 inches for Fusible C-905® (potable water) 4-36 inches for FPVC™ (potable water in other than C900/C905 dimensions and non-potable applications)
Thickness Range, inches	Fusible C-900: DR 14, 18, 25 Fusible C-905: DR 14, 18, 21, 25, 32.5, 41, 51 FPVC: DR 14, 18, 21, 25, 26, 32.5, 41, 51, Sch 40, Sch 80 D3034 and F679 Sewer sizes through 36 inches
Pressure Capacity, psi	165 psi – 305 psi under C900; 80 psi – 235 psi under C905

Technology/Method	Sliplining/HDD/Pipe Bursting/Direct Bury
Temperature Range, °F	Limited to 140°F and below. Above 73°F standard internal pressure de-rating factors apply for long-term elevated temperature exposure
Renewal Length, feet	Standard guidance of 300-500 feet for pipe bursting with length of >1,000 feet completed in a single burst. Slipline length of 3,500 feet in a single pull have been completed. HDD lengths of over 5,100 feet in a single length.
Other Notes	Not available.
III. Technology Design, Installation, and QA/QC Information	
Product Standards	AWWA C900, AWWA C905, NSF 61 Certified (for potable water applications), ASTM D2241, D3034, F679, D1785
Design Standards	AWWA C900, AWWA C905
Design Life Range	100+ years
Installation Standards	ASCE "Pipe Bursting Projects" - ASCE Manual and Report on Engineering Practice #112. AWWA installation standard is in development.
Installation Methodology	For sliplining, host pipe is cleaned and CCTV inspected. Depending on site logistics, the Fusible PVC™ pipes can be strung out and the joints butt fused above grade prior to insertion, or butt fused in the ditch. For pipe bursting, the pipe normally is butt fused in a single length. Static burst methods only are used. The fused PVC pipe is either winched into the host pipe for sliplining, or pulled in behind the expansion head for pipe bursting. A non-rigid connection from the pipe to the expansion head is used. In all installation methods the maximum recommended pull force and the minimum recommended bend radius must be followed.
QA/QC	The stock pipe is subjected to all of the normal QC requirements in AWWA C900/C905, including dimensional conformance, flattening, acetone immersion, hydrostatic, and burst tests. UGSI includes impact, heat reversion, and axial tensile testing as well. In addition 3 rd party labs are used to confirm extrusion results on key tests prior to shipment. The fusion process parameters of pressure and the time are recorded for each joint using a datalogger. Additional parameters such as the heat plate temperature are also recorded.
IV. Operation and Maintenance Requirements	
O&M Needs	No special O&M needs.
Repair Requirements for Rehabilitated Sections	Cut out and replace with AWWA PVC of the same OD, using repair clamps and all standard PVC and DI water works fittings.
V. Costs	
Key Cost Factors	Benefits: Due to the high tensile strength of PVC (compared to softer thermoplastic rehab materials), Fusible PVC™ allows longer lengths of cased and uncased pulls, which can reduce the number and cost of pit excavations required. Reduced wall thickness for a given pressure maximizes inner diameter (ID) for a given outer diameter (OD) either maximizing flow in an OD constrained environment or minimizing cost of pipe material and installation as well as risk for a given ID and pressure requirement. Additional ease and reduced cost of reconnections using standard water works fittings. Limitations: Due to limitations of bending radius, Fusible PVC™ may require longer insertion pits over softer thermoplastics.
Case Study Costs	Fusible PVC™ pipe was used for a 5,120 feet directional drill crossing under the Beaufort River for the Beaufort Jasper Water & Sewer Authority in June of 2007 and was compared in costs to both steel and HDPE pipe. The overall project cost \$1.7 million and the customer estimated savings of \$400,000 (materials and installation) by selecting Fusible PVC™ pipe over other materials for the drill portion.
VI. Data Sources	
References	www.undergroundolutions.com